

OLED Technology Trends

LED Technologies for Streetlighting

Smart Lighting - Sensor & Wireless Control

LED Reliability - Overstress & Solder Joints

EPISTAR

www.epistar.com



Actualize LED Potential

----- Co-activation Service

----- Full Spectrum LED Chips

----- Chip Solutions for Various Applications

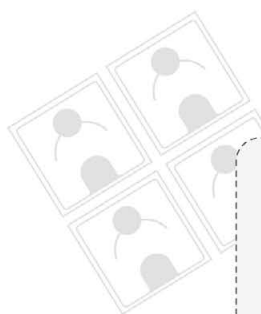

We sincerely invite you to learn more about our chip solutions.

Light+Building 2014

Date 30.03.2014 - 04.04.2014

Location Messe Frankfurt Fairground

Booth 6.2 C66

Headquarters
EPISTAR Corporation
5 Li-hsin 5th Road, Hsinchu Science Park,
Hsinchu 300, Taiwan
T: +886 3-567-8000 F: +886 3-579-0801
sales@epistar.com.tw

China Sales Office
Luxlite(Shenzhen)Corporation Limited.
21F, Sunshine Golf Building, Shennan Road,
Futian District Shenzhen 518040, China
T: +86 755-3335-5666 F: +86 755-3335-5777
sales168@luxlite.cn



Website



Facebook



微信



Human Centric Lighting

The contemporary term “Human Centric Lighting” (HCL) is probably popular these days because of a current survey conducted by LightingEurope, ZVEI and A.T. Kearney, which stated that HCL should cover 7% of the total European market for luminaires by the year 2020. A couple of decades ago, first investigations were made concentrating on blue light with shift workers. The results clearly showed a significant influence of colored light on the human circadian rhythm.

So why has HCL come into focus again today?

Solid-State Lighting technology opened up this topic again but it looks at it in a new way. It's not only the easy way of changing colors, tuning CCTs, dimming light or daylight controlled lighting, but light is getting digital. This means that physical parameters such as wavelengths, pulse widths, on/off transitions and dimming speeds, or to put it in a nutshell, the inner-light values of artificial light, can be modified with LED and OLED technologies.

There are many questions about how these parameters or parameter-sets may influence human beings. Existing studies show, to some extent, the positive effects on circadian rhythms, mood, visual acuity performance and sustainability that can be gained by applying HCL.

The merging of LED lighting technology with scientifically based human-centric approaches offers opportunities not solely for the manufacturers of Solid-State Lighting but it will also open many windows of opportunity for other sectors, such as engineering, architecture and software providers to name just a few.

Western and central Europe may become the largest predicted market of LED-based human-centric lighting with an estimated 75% by the year 2020.

SSL technologies in conjunction with intelligent control algorithms open the door to enhance lighting in a broad area of applications such as schools, hospitals, offices and many more.

Solid technologies for LED lighting are covered in this issue of LED professional Review. You'll be able to read about wireless controls and sensors, and reliability and lifetime issues. To top it off, Arno Grabher-Meyer, our Editor-in-Chief, has brought you the latest news from LED Lighting Japan in Tokyo, which took place in January this year.

Have a great read.

Yours Sincerely,

A handwritten signature in blue ink, appearing to read 'Siegfried Luger'.

Siegfried Luger
Publisher - LED professional

Content

■	EDITORIAL IMPRINT	p 1 p 84	COMMENTARY NEWS - PRODUCTS NEWS - RESEARCH	p 4 p 6 p 26
---	------------------------------	-------------	-----------------------------------------------------------	--------------------

■	EVENTS			
	Lighting Japan – Strong Focus on OLEDs by Arno Grabher-Meyer, LED professional			p 30

■	INTERVIEW - PROF. FISCHER-HIRCHERT			
	Using LED Technology in Street Lighting by Siegfried Luger, LED professional			p 42

■	TECHNOLOGY			
	Solder Joint Reliability of LED Packages by Saritha Rajamma, Cree Corp.			p 46

■	ELECTRONICS			
	Electrical Overstress Protection of LEDs with Proper Circuit Design and Layout Practices by Ron Bonné, Takaaki Yagi & Masaki Nishizawa, Philips Lumileds			p 52
	Driving Large Scale LED Panels Efficiently K.H. Loo, Y.M. Lai & C.K. Tse, The Hong Kong Polytechnic University			p 60

■	APPLICATION			
	Sensor-Driven Designs to Allow More LED Bins and Lower Costs by Sajol Ghoshal, ams			p 64
	LED Light Tile Technology for Lighting and Backlighting by Dr. James Gourlay, Design LED Products			p 70

■	STANDARDIZATION			
	ZigBee Light Link – The Technology for Residential Wireless Lighting Control Simon den Uijl et al., The Connected Lighting Alliance			p 74

■	OPTICS			
	Using Interactive Optimization Utilities to Improve LED Lightpipe Designs Dr. Edward Freniere & Michael Gauvin, Lambda Research Corp.			p 78

Advertising Index

Epistar	C 2
Cirrus Logic	p 3
BICOM	p 5
Vossloh-Schwabe	p 7
StellarNet	p 9
GL Optic	p 11
Zhaga Consortium	p 11
Konica-Minolta	p 13
LedLink	p 17
Global Lighting Technologies	p 19
ams	p 21
Barthelme	p 23
Recom	p 25
Philips Lumileds	p 26
Cree	p 27
Mexxotech	p 28
Lextar	p 29
Everfine	p 33
Edison	p 33
Refond	p 37
Supertex	p 40
Willighting	p 40
Radiant Zemax	p 41
Signcomplex	p 45
LED Lighting Taiwan	p 51
Semileds	p 55
CeramTec	p 55
Instrument Systems	p 59
Underwriters Labs	p 63
Light Fair International	p 65
Assodel/Technoimprese	p 69
Cree	p 73
China Int. Optoelectronic Expo	p 77
LEDTech Asia	p 79
LEDTechExpo Moscow	p 83
LpS 2014	C 3
WAGO	C 4



Light Years Ahead

Setting the Standard for Dimmer Compatibility

CS161X Family of Dimmable LED Driver ICs

The CS161X family of digital LED controller ICs have been tested to provide near 100 percent compatibility with a wide array of dimmers worldwide. The CS161X's digital intelligence recognizes the dimmer in use and adapts the algorithm to provide smooth, flicker-free dimming in single and multi-lamp configurations.

- Best-in-class dimmer compatibility
 - Elegant "flicker-free" dimming
 - Dimmable to 0% of light output
- Up to 90% efficiency
- 5% output current regulation
- >0.9 power factor

Stay current at www.cirrus.com/ledprocs161x and request a free sample.





Annetta Kelso

Annetta Kelso has worked for Philips Lighting in the UK and the Netherlands for over 26 years. She has held a variety of roles from Lighting Application Manager, Product Manager, Marketing Manager to Senior European Marketing Manager in the OEM channel. She was responsible for setting up the marketing of the Philips LED module approach and the market introductions for the Fortimo LED systems in Europe. Other activities include managing the Philips LED module training of European OEMs and being a key member of the Zhaga Promotion work group.

THIS CHANGING LIGHTING WORLD - OR HOW TECHNOLOGY IS CHANGING THE LIGHTING LANDSCAPE

After a whirlwind introduction, B2B lighting manufacturers are coming to grips with the new LED technology, its potential and challenges. The comfortable, traditional lighting world of the 20th century has gone forever. But to what extent is electrification changing the B2B lighting landscape? What and who is changing and where will it lead?

Manufacturing of lighting components, light sources and luminaires has been completely revolutionized in the last 5 years. Speed to market has become a new key performance indicator, whilst the need to 'differentiate' is universally expressed. One of the main changes is luminaire manufacturers grasping the opportunity to take on parts, or all, of the specifying, design and manufacturing of the LED light engine inside the luminaire. In an evolving technology with short product life cycles and a market with fierce price erosion, this means constant product portfolio maintenance, upgrading and optimization is required. Whether this is a sustainable, profitable manufacturing business model remains to be seen. Economic reality may dictate that lighting manufacturers have to make smart choices about the scale and extent of their core competences, possibly leading to reduced product portfolios, or a strategic choice to specialize in a certain area.

Another change LED technology has brought is the importance and impact of logistics. Component sourcing is now carried out on a global basis and manufacturers need to closely monitor the product roadmaps of all suppliers to anticipate changes of certain key components, which have implications for their own products. The value of obsolescent stock at the end of a financial year can have a huge negative impact on margins, making accurate forecasting and planning essential. The lighting industry will also have to find ways of handling its relatively low ranking in the electronics supply chain at moments of scarcity. The biannual shortages of electronic driver components could become more mainstream and start to have a larger effect on project availability.

The potential impact electrification may have on the quality and reliability of lighting installations is considerable.

The fast moving consumer goods industry has a 'throw away and replace' culture. Lighting in an office, or on the motorways, however, 'should work forever'. It is fundamentally important to avoid a culture of early failures and short life, giving LEDs and all those associated with the Industry a bad name. The quality of the components used and quality in manufacturing processes requires the highest attention from lighting manufacturers and here there is a lot of work still to be done.

LED technology is steadily penetrating per application, with down lighting and spot lighting leading the way. There is one area, however, showing little noticeable change. End users and lighting designers seem reluctant to compromise the way they want to use or experience light. The preference for a certain color temperature in fashion retail lighting or in offices has not changed. Luminaire form factors, light levels and CRI choices are still the same. Lighting in an office is still expected to come from above and not from the walls. The message is clear: lighting innovation needs to conform to well-established, emotional patterns of behavior and fit with the needs of the application.

LED market transformation is now in the 2nd phase, characterized by rapid growth, increasing market penetration and fast price erosion. Every part of the value chain is feeling the impact and learning how to adapt to the challenges this poses. But the real changes of the new technology are likely to become more evident in the phase 3. Here connectivity and the connected world will become the norm, changing the way we use and experience light. Technology will offer multiple possibilities and the challenge will be to define where the opportunities lie and what the real benefit is of connected lighting systems. It comes back to knowing and understanding the lighting market, determining what is meaningful innovation and for which professional applications it is essential, desirable or a luxury.

And if we can get that right then maybe lighting will move up the scale of end user priorities, becoming important and exciting, appealing to a new, younger generation, rather than a necessary functional requirement and after-thought.

A.K.

BICOM

Professional LED Lenses & Reflectors Manufacturer

- Develop over 100 new products monthly
- Cooperate closely with Osram, Philips, Cree, Nichia etc.
- Have rich industry experience in optics design and manufacture
- Finish a new optical design within 3 days & Trial-mould samples in 5 days
- Provide high efficiency LED Lenses, Reflectors, Tube & Bulb Covers



LED Tube Cover

Single Lens



Reflector



LED Bulb Cover



Streetlight Lens



sales@bicomoptics.com

SHENZHEN, CHINA
HONGKONG
SHANGHAI

TEL: +86-755-29199996
TEL: +852-39216016
TEL: +86-21-33634169

FAX: +86-755-82033711
FAX: +852-27837978
FAX: +86-21-33634512



ADD: B4 BUILDING, XINJIANXING INDUSTRIAL PARK, FENGXIN ROAD, GUANGMING DISTRICT, SHENZHEN

www.bicomoptics.com

American Bright LED® Launches Intelligent LED Modules

American Bright LED is introducing two LED modules: EzyLED™, a new line of LED module with a driver IC integrated for current control and is designed to be used in any 24 V system, and GoldenEye™, an AC LED module that allows LEDs to be driven from direct 120 VAC without using any capacitors, coils or resistors.



New EzyLED and GoldenEye prototypes are now ready for primetime and complement manufacturers' luminaires

EzyLED:

Using state-of-the-art high voltage LED technology with built-in IC, EzyLED is easily adopted into scalable or modular lighting applications. It manages the load and provides constant current to the packages when set-up in parallel.

EzyLED features:

- 24 V direct input with integrated IC for current management
- Available in 5050, 5630 and K2 packages for various lighting applications
- Lowers component failure rate and BOM cost
- Improves system efficacy and robustness

GoldenEye:

While compact in size – a little smaller than a US quarter – GoldenEye packs 10 W of lighting power and offers uniformity, efficiency and configurability* in an all-solid-state, dimmable** package. Using direct 120 VAC power input means that no external power supply or ballast are needed.

Unlike other industry LED modules, GoldenEye does NOT require soldering to connect to the AC line voltage. The module

simply plugs in with wires, maximizes efficiency, reduces part count and design complexity, improves reliability, and lessens costs, a winning combination for manufacturers.

GoldenEye Features:

- High power LED module with Patented SimpleDrive™ technology
- Direct AC connection for easy adoption
- High lumen efficacy and CRI
- Advanced Chip-on-Board design

* Wattage reconfigurable from 4 W to 12 W with same high efficacy

** With electronic (trailing edge)

The modules have been tested for flickering index and dimming compatibility per Energy Star™ criteria, and IES LM82-13 for electrical and photometric performance in various ambient temperatures. Additionally, the luminous flux and CCT hold well after 2000 hours under both 25°C room temperature and an elevated 45°C environment. The lifetime test is ongoing and luminaire manufacturers will be provided with at least 6000 hours test data to use for design/warranty reference, and applications for Energy Star or Designlights Consortium. ■

Soraa Introduces GaN on GaN™ Gen3 LEDs

Soraa, the world leader in GaN on GaN™ LED technology, announced the world's most efficient LED, which it will integrate into the market's first full-visible-spectrum, large form factor lamps. Soraa's third generation (Gen3) GaN on GaN™ LED achieves world-record setting wall-plug-efficiency, outperforming the nearest competitor by 20% at normal operating conditions.

Soraa's Gen3 Chip-on-Board Package

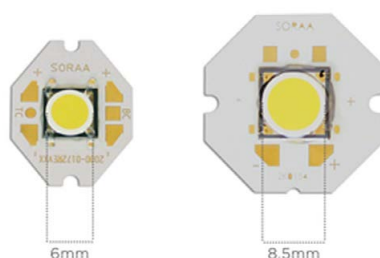

Soraa claims the new Gen3 LEDs have achieved a 30% lm/W efficiency improvement and are to be the world's most efficient LEDs

In just one year, Soraa has achieved a remarkable 30% increase in efficiency over its prior generation LED, setting a pace of technology evolution unrivalled in the LED industry. Soraa's Gen3 LED will be available in the second quarter of this year in a variety of product offerings: modules, large form factor PAR and AR lamps, and MR16 lamps.

Soraa's full-visible-spectrum PAR30L lamp, powered by its Gen3 LED, will lead the market not only in light output, but also in color and whiteness rendering; at CRI-95 and R9-95 it will achieve center-beam intensity (CBCP) of 28,250 cd at 8° beam angle, 10% higher than the CRI-85 offering of the nearest competitor. Soraa's large form factor lamps will feature all the signature elements of light quality that its customers are accustomed to: natural and accurate rendering of colors and whiteness, perfectly uniform beams of exceptionally high intensity, and clear single shadows.

Soraa has brought a culture of innovation and rapid technology development to the LED lighting industry with its GaN on GaN™ LED technology. The company's Gen3 LED runs at 75% wall-plug-efficiency at a current density of 35 A/cm² and a junction temperature of 85°C, efficiency levels that are out of reach for other LED manufacturers. Soraa leverages the properties of the native GaN substrate and a chip-on-board LED package design to create a very robust, single point source that enables excellent beam control. And with a proprietary three-phosphor combination, Soraa's Gen3 LED emits full-visible-spectrum light (all the colors of the rainbow, including violet), which excites optical brightening agents and perfectly renders whiteness as well as colors. ■

Luminus XNOVA COB LEDs Achieve 145 LPW at 5000 K

Luminus Devices Inc., a global manufacturer of high-performance LEDs, announced that its flagship XNOVA white Chip-On-Board (COB) products reached full mass production while setting another benchmark with industry-leading efficacy for both cool and warm white. Typical performance was measured at up to 145 lm/W at 5000 K, and

132 lm/W for 3000 K at room temperature. Hot lumens per Watt at 85°C, a more representative view of what customers can expect in real-life conditions, attained a remarkable 134 lm/W at 5000 K and 122 lm/W at 3000 K.



Luminus Device's new XNOVA COB LEDs offer highest performance and are available as High-CRI versions and narrow 2-step binning

Main Features:

- Efficacy over 120 lpW provide energy savings in Warm White
- CRI options of 80 / 90 / 95 to meet a range of application demands
- 2-step and 3-step binning options for high level of color uniformity array to array
- Flux options ranging from 300 lumens to > 9000 lumens

The XNOVA COB LED portfolio offers a wide range of devices with Light Emitting Surface (LES) from 6 mm to 27 mm. Products are currently available with 80, 90 or 95 minimum CRI and color temperatures of 2700K, 3000K, 3500K, 4000K, 5000K, with 6500K launching next month. In addition, devices with AccuWhite technology combine a high color rendering with high efficacy and are ideal for directional lighting applications in commercial, retail and hospitality markets.

“Our LED portfolio has a solution for virtually every directional application from 300 lm MR-16s to over 10,000 lm commercial lighting fixtures,” added Stephane Bellosguardo, Vice-President of Global Marketing. “COBs are one of the fastest growing technologies in global lighting markets. Each XNOVA COB product achieves top metrics for

its target applications enabling lighting equipment designers to create cost-effective yet innovative products whether targeting commercial or residential markets.” ■

Philips Lumileds' LUXEON Lime LEDs Break 200 lpW Barrier

LUXEON Lime, the newest addition to the widely renowned LUXEON color portfolio of LEDs from Philips Lumileds, enables lighting designers to take the next step in delivering the highest quality, tunable white light in bulbs and fixtures. LUXEON Rebel ES Lime is the proprietary LED technology in the revolutionary Philips hue bulb, where it combines with LUXEON Rebel Red-Orange and Rebel Royal Blue emitters to deliver over 16 million color options - all controlled from an iOS device. Philips hue can use color tunable Light Recipes to help set mood and energy level in the home, office, retail, classroom and hospital environments.

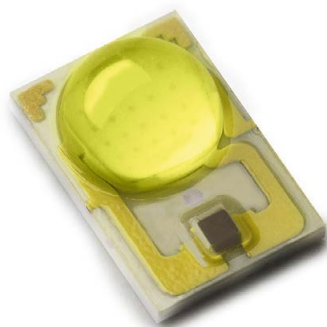

The latest addition to Philips Lumileds' color portfolio of LEDs, the LUXEON Lime LED exceeds 200 lm/W efficiency

Lime is the highest efficacy LUXEON LED manufactured to date. Therefore it enables highly efficient color mixing by providing a convenient above-blackbody color point with

Visit us at the

LIGHT+BUILDING

30 March to 4 April 2014
Hall 4.0, Booth B50

V5 LIGHTING SOLUTIONS



LUGA Shop Pearl White

Impress your customers with the unique light quality of LUGA Shop Pearl White, the new star on the fashion horizon and the future of shop lighting.



**Brilliant colours
High CRI
L90/F10 | > 140 lm/W**

www.vossloh-schwabe.com

A member of the Panasonic group **Panasonic**

optimal standalone efficiency of 200 lm/W at 350 mA and 85°C. The spectral output of Lime is closely aligned with the wavelength that human eye cones are most sensitive to 555 nm.

In addition to LUXEON Rebel ES, the Lime technology is offered in the LUXEON Z format, an undomed, 2.2 mm² LED that is 75% smaller than most high power LEDs. In spotlight and downlight applications, the LUXEON Z enables tighter packing density and better color mixing control. The LUXEON Z Lime can be combined with Red and Blue LEDs to achieve a broad spectrum of saturated colors. Alternatively, tunable white light with high efficacy can be achieved from 1800-6500 K along the blackbody curve.

Because Lime is closer to the blackbody curve than green LEDs, much less inefficient red is needed to make white light with Lime instead of green, especially at warmer color temperatures. For instance, color tuning of 2250-2950 K can be achieved with an R9>90, CRI>90 and efficacy of 90 lm/W using LUXEON Z combinations. When using a similar combination of Red, Green and Blue LEDs to create 3000 K white light, the CRI is close to 20. ■

Sharp Extends the MegaZenigata Family

Sharp has announced a key extension to its family of MegaZenigata LEDs with a new range of high-efficiency XFC models in the 15, 25, 35 and 50 wattage classes.



Sharp's new MegaZenigata LEDs with a new range of high-efficiency XFC models in the 15, 25, 35 and 50 wattage classes deliver up to 113 lm/W

Efficiency Optimized:

This new line-up features the same footprint and compact design (24 x 20 mm) as the existing MegaZenigata LEDs to ensure uncomplicated replacement and make life easier for light fixture manufacturers. Another facilitating factor in optical design terms is the unchanged small, circular light-emitting area (diameter: 17 mm). What has changed, and most significantly so, is the level of efficiency. These new efficiency-optimized LEDs combine greater efficacy with a lower drive voltage.

Standout Features:

Besides the considerable improvement in efficacy, the new XFC line-up scores with uniform, high-quality illumination, luminous flux of 1,000-6,000 lm, luminous efficacy of up to 113 lm/W, and CRI options of Ra 70+, 80+ and 90+. Besides, these XFC LEDs feature Energy Star®-compliant CCT and CRI ratings. The color variation is within a 3 MacAdam ellipse and there are five color temperature options. These chip-on-board LEDs feature a ceramic substrate in all wattage classes and come with only two terminal connections for easy installation. Like other Sharp LEDs, they have a lifetime in excess of 40,000 hours depending on the operating conditions, with an operating temperature range of -30° to +100°C.

Possible Applications:

This new line-up of high-efficiency LEDs is suitable for general lighting applications, indoor lighting (e.g. spotlights, downlights or recessed ceiling lighting fixtures) and outdoor lighting (e.g. street, subway, station or bridge lighting or object illumination). ■

Cree Improves CXA Array LEDs for Industry's Highest Lumen Density

Three new LED arrays from Cree, Inc. redefine what is possible for LED lighting in high-intensity applications. The Cree® XLamp® CXA2590, CXA1850 and CXA1310 High-Density LED Arrays double the light output of existing standard-density CXA LED arrays without increasing the size. This unparalleled increase in lumen density delivers new levels of light intensity, which enables the complete replacement of ceramic metal halide (CMH)

light sources, expands the possibilities of LED spotlights and enables applications that could not be addressed by previous LED technologies.



Cree's improved CXA Array LEDs with industry's highest lumen density unlock new designs and applications for LED lighting

By emitting more than 15,500 lumens from a 19 mm light source, the CXA2590 LED Array enables luminaires with the same center beam candlepower (CBCP) and light quality of a 150-watt CMH light source at lower power, longer lifetime and with better control. Delivering more than 9,000 lumens from a 12 mm light source, the CXA1850 LED Array enables lighting solutions with the same CBCP and light quality as 70-watt CMH while using half the power. The CXA1310 LED Array provides more than 2,000 lumens in a 6 mm light source, which allows lighting manufacturers to design smaller, more efficient track lights, reduce the size of halogen replacements by half and deliver twice the CBCP of CMH at 30% less power.

Cree continues to lead the industry by offering the only portfolio of high-density LED arrays. Having multiple size and lumen output options from the extended CXA product family helps lighting manufacturers address a wide range of lighting applications from small form factor halogen and CMH, to sports and stadium lighting. Lighting manufacturers can also take advantage of the CXA's ability to increase light output without increasing size.

Offering the industry's best color consistency for designs that use only one LED, Cree XLamp CXA LED Arrays are characterized and binned at 85°C, available in ANSI White and EasyWhite® color temperatures (2700 K – 6500 K), and CRI options of 70, 80 and 95. Samples of all new high-density LED arrays are available now and production quantities are available with standard lead times. ■

Kingbright's "Minikin-Air" - Industry's Thinnest SMD LEDs

Kingbright announces the availability of the new Minikin-Air series – A new line of ultra thin SMD LEDs. Using the latest AlGaInP and InGaN materials, Kingbright utilizes the most advanced technology to engineer the industry's smallest and thinnest SMD LEDs. It not only reduces the mounting area by more than 50% compared to the conventional 0603 SMD LEDs, its height is only about ¼ of the standard SMD LEDs.

LED SIZE COMPARISON

(Minikin-Air vs 0603 SMD LEDs)



Kingbright's new APG1005 (0402 package) and right angle package APGA1602 SMD LEDs are especially - but not only - predestined for portable applications and new thinner designs

As electronics shrink down to new levels of portability, manufacturers have figured out how to cram more high functioning components in a more compressed board area. The Minikin-Air series is the perfect choice for design engineers as it represents the smallest, thinnest, yet still powerful high quality LEDs. The top-emitting package in the Minikin-Air series (APG1005) is the industry standard 0402 package size, but only 0.2 mm in height. The right angle package (APGA1602) is also astonishingly small, measuring at 1.6 mm in width and 0.2 mm in height.

In compliance with RoHS and REACH regulations, the Minikin-Air series is available in Blue, True Green, Amber, Orange, and Red. Not only these ultra-thin SMD LEDs are impressively petite but packs big punches, they are ideal for many types of today's popular electronics. The lightweight and miniaturization of the physical size of these ultra-thin SMD LEDs makes them optimal for mobile applications, portable devices, or any design with a space constraint. ■

Samsung Claims CoB LED Packages with Industry's Highest Efficacy

Samsung Electronics Co., Ltd., a world leader in advanced component solutions, announced that it has raised the light efficacy for its chip-on-board (COB) family of LED packages to the highest in the industry. Samsung's LC013B, LC026B and LC040B feature a compact light-emitting surface (LES) with high light output that is designed for use in high performance LED products.



Samsung's COB type LC series offers a light efficacy of 130lm/W at 3000K CCT

The improved COB type LC series offers a light efficacy of 130 lm/W at 3000 K CCT (Correlated Color Temperature) and 143 lm/W at 5000 K with a CRI (Color Rendering Index) over 80. This represents a significant improvement from 120 lm/W at 3000 K and 129 lm/W at 5000 K respectively, which is the light efficacy levels that Samsung has been offering with its LC series since April. Using its leading-edge phosphor technology and chip fabrication techniques, Samsung developed the LC series enhancement to provide greater differentiated value to its customers.

Samsung's LC series is also Zhaga-compliant, making the packages highly convenient in assembling most LED lighting products. By enabling exceptional design efficiency for LED lighting, Samsung's latest LC series is expected to be applied in a wide range of interior LED lighting applications including downlights, spotlights and directional retrofits such as MR/PAR lamps.

Measure your LEDs LED MEASUREMENT SYSTEMS LOW COST ■ NIST TRACEABLE



Watts/m² ■ Watt Flux ■ LUX ■ Lumen
CRI & CQS ■ Color Purity ■ CCT
Dominant λ ■ PAR ■ xy Chromaticity

12" sphere features a vertical hinge & sample stage with powered test sockets with many adaptors. Aux & Cal lamps with data files included



NEW Integrating Tube 5' T8/10/12 Tube LED lights!

StellarNet is a worldwide provider of low cost, rugged measurement systems. All spectroradiometers are NIST calibrated to provide real time absolute intensity measurements. These systems provide reliable and high performance analysis for a multitude of light measurements. Contact us today for a same day quote!

www.StellarNet.us ■ (+)1-813-855-8687



In addition, by leveraging the chromaticity control standard 3-step MacAdam ellipses, the LC series offer high color uniformity and light quality. The packages also provide low thermal resistance and superior heat dissipation which enable high reliability, and have successfully completed LM-80 testing, a widely observed test method for lumen maintenance developed by the Illuminating Engineering Society.

The Samsung LC series has been available in 2700 K, 3000 K, 4000 K and 5000 K versions, with a 3500 K version now added. Samsung's latest LC series also offers a diversity of wattages coming in 13 W, 26 W and 40 W versions depending on the LED product with which the packages are used.

The LC013B, LC026B and LC040B with improved light efficacy will be available in the market beginning in February and will be updated to have a CRI above 90 in the first half of the year. ■

Edison Opto Combines ANSI Bins with MacAdam Ellipse

In order to provide comprehensive sales service and enhance the capacity utilization of PLCC, the Taiwanese LED manufacturer, Edison Opto, initiated the combination of the ANSI Bin group with the concept of MacAdam ellipse and subdivide the color temperature into 9 subgroups.

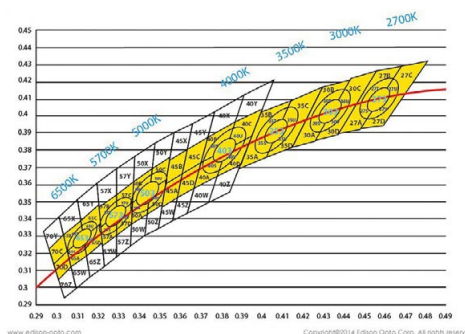

Edison Opto's new binning scheme offers greater flexibility while narrowing tolerances of color consistency and CCT control

The new Bin group is conducive to inventory management. Also, the packaging sales service, which is provided by Edison Opto, is more convenient to customers' product selection.

If we look at 2700 K, for example, Edison's new Bin group is to subdivide the color temperature into 9 subgroups (the outside of 5-step MacAdam ellipse are 27A, 27B, 27C and 27D; the section between 3-step and 5-step MacAdam ellipse are 27S, 27T, 27U and 27V; the inside of 3-step MacAdam ellipse is 273). Customers can mix components from different Bin groups to attain the desired color temperature (for example, we can mix 27U and 27S in 1:1 ratio to control the color temperature within 3-step MacAdam ellipse) so that the products that are off-center can achieve the goals of color consistency and CCT control.

The new PLCC Bin group can not only control color temperature more precisely but also enhance the capacity utilization. Moreover, Edison Opto can provide customers the mix Bin service at a preferential price and help to improve the color consistency of luminaires. ■

Xicato Improves XLM & XSM Modules

Xicato, a leading developer of superior light quality from LED modules, is addressing a 'gap' in lighting designers' portfolios with the XLM LED module which has a rectangular light emitting surface that enables an efficient rectangular beam with light quality that rivals that of halogen lamps. Xicato furthermore announced that its 4,000 lumen XSM LED module achieves new levels of light output and light density without increasing the form factor or light emitting surface.



Xicato's XLM LED Module delivers the light output and quality that used to come from halogen

XLM LED Module:

Most lit spaces are in some way rectangular or square and most light sources emit a round beam. This is fine for downlights but for wall washing, asymmetric up-lighting and certain types of accent lighting, a rectangular beam is often preferred. Xicato addresses this problem with a rectangular light-emitting surface on its XLM LED module. The XLM incorporates Xicato's Corrected Cold Phosphor

Technology® and adheres to the company's exacting standards for color quality and consistency initially and over time.

Today luminaire manufacturers are incorporating the XLM module into a range of solutions for lighting designers to choose from including track lighting, wall washers, recessed lighting and other form factors. Examples of available XLM luminaires can be seen in Xicato's luminaire gallery where solutions from global lighting companies including Lighting Services Inc., Projection Lighting, OMS, Electron, Edison Price, Wila, Times Square Lighting, Arcluce, PSM, Exterus, Forma Lighting and Stratas.

XSM LED Module:

Xicato's new 4,000 lm XSM LED module enables more light in applications and it allows for better, tighter beam control from luminaires that incorporate the XSM light source.

The XSM 4000 is ideal for general lighting high ceiling applications and accent lighting applications that require center-beams of 30,000 candela (cd) and greater or very narrow light beams. Xicato's new 4,000 lumen module enables luminaire manufacturers to compete for a larger portion of the ceramic metal halide lamp market which is prevalent in retail segments, and provide lower operating costs, ownership costs, while improving light quality. Implementation is easy as the form factor is exactly the same as all other XSM modules and an extensive ecosystem of drivers (including deep dimming), heat sinks, and reflectors have already been identified. For manufacturers already using Xicato's 3,000 lumen module, the thermal class remains the same, further simplifying portfolio expansion.

Remote phosphor light sources are known for their superior ability to maintain color and quality but as flux density increases, maintaining superior color and quality has been challenging. Xicato's new XSM 4,000 lumen offering delivers the high flux and because of the company's Corrected Cold Phosphor Technology™, it does so while retaining stable color and consistency performance over its lifetime and therefore is covered by Xicato's unique 5 year color consistency and lumen maintenance warranty.

The XSM 4,000 lm Standard Series module is available now in 3,000 K, 3,500 K and 4,000 K correlated color temperatures (CCTs). ■



**Touch
the technology**

GL SPECTIS 1.0 touch
Introducing world's first smart spectrometer.

If you need to measure:

- **Lux** – illumination value
- **Lumen** – the luminous flux
- **CRI** – color rendering index according to CIE
- **CCT** – correlated color temperature according to CIE standard
- **COLOR** – color coordinates according to CIE 1931 and CIE 1964
- **mWatt** – radiant power value.



www.gloptic.com

GL OPTIC Light measurement solutions

TDE-Lighttech Releases LED-Pixel Module System

The PixLED - RGBW4506 is a LED-pixel module. It is a solid-state design equipped with six, highly intense RGB LED's. Due to its ultra-high visual refresh rate (patented technology), the LED-module is extremely suitable for studio and entertainment applications. The PixLED has a true 16-bit color depth in order to create finer levels of color and display better gradient effects.

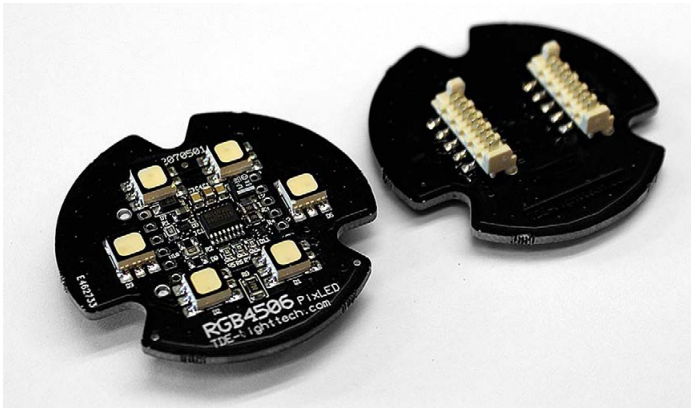

TDE-Lighttech's PixLED - RGBW4506 offers an ultra-high visual refresh rate and true 16-bit color depth

Features:

- Power: 24 VDC
- Consumption: 1,5 Watt / Pixel
- LEDs: 6 x One Chip RGB
- Optics: Opal or Clear dome, 50 mm
- String: Maximum 100 x PixLED module*
- Dimensions: ø45 mm

* Depending on cable lengths and power supply

The dome of the PixLED is 50mm in diameter and comes with an opal or clear PC lens. The PixLED-modules are daisy chain connected to each other using an automatic addressing mode. Each string of PixLED-modules is connected to the AD-UDR1 Dynamic LED-driver with a maximum of 100 modules per driver*. ■

Zhaga

Zhaga means business

With widespread support from the international lighting community, the Zhaga consortium has created numerous specifications for LED light engines and has certified hundreds of products.

See how your business can benefit:

- Future-proof luminaire designs
- Multiple suppliers of compatible products
- Faster time to market
- Lower R&D costs
- Easier upgrades and maintenance

Visit Zhaga at
Light+Building 2014
Hall 4.2, booth A15



Find Zhaga members and certified products at Light+Building 2014.

www.zhagastandard.org/lb

Lumex Adds High-Voltage, Low-Current Version To Its TitanBrite Family

Lumex announces the global launch of its TitanBrite High-Voltage, Low-Current LED; the newest addition to the TitanBrite family of high-power LEDs. The TitanBrite High-Voltage, Low-Current LED can run at a higher voltage with a lower current than alternative technologies (such as a traditional 10W LED) while providing up to 45% brighter light output and superior light distribution. This allows for up to 20% cost and 50% real estate savings for applications requiring low current, but high light output.

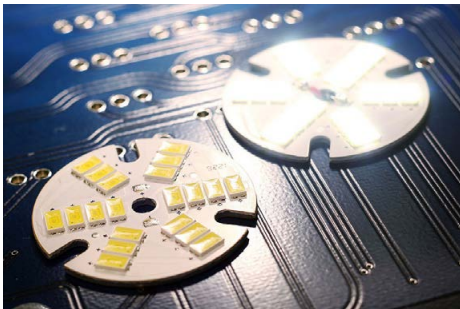

Lumex's TitanBrite, High-Voltage, Low-Current LEDs can run at a higher voltage with a lower current than alternative technologies while providing brighter light output and superior light distribution

Applications:

- Industrial: Inspection lighting: anywhere you use high voltage application, such as automated visual inspection, backlight sorting machines, and warning lights
- Medical: Spotlighting, backlighting (for x-rays), operating lighting
- Commercial: Backlighting for electronic signage (large illuminated ads at train stations, airport terminals and fast food restaurants), machine lighting, production lighting
- General: Lighting fixtures (parking garages), light arrays, spotlights

TitanBrite High-Voltage, Low-Current LEDs are a good option for lighting and fixture designers for a number of applications across a wide range of industries.

Though high-voltage, low-current LEDs provide key performance benefits for applications that use LED drivers that offer higher voltages to drive a high-power LED,

few design engineers are aware that these technologies are available and can produce the comparable if not brighter light output.

Because a high-voltage LED (33 volts and up) runs at a lower current, it doesn't conduct as much heat, simplifying heat dissipation design considerations and ensuring less energy loss in heat generation and control. The need for bulky heat sync elements is eliminated as the high-voltage LED has a built-in metal core PCB and doesn't require additional heat sync components. This results in real estate savings of up to 50% as well as up to 20% cost savings.

The current level of an LED is a primary concern because power must be conserved, particularly for power-intensive applications. A low-current unit is also less hazardous than a high current one.

This low-current LED design also offers greater light distribution than traditional standard LEDs that provide light in concentrated area or "hot spot". A cluster of LEDs offer a viewing angle of 120°, eliminating hot spot issues.

The TitanBrite High-Voltage, Low-Current LED also offers up to 45% brighter light output than a traditional 10W LED. With almost double the amount of light in a single unit, the cluster array of LEDs is placed in a unique pattern that allows the design to achieve this output.

Lumex's new TitanBrite High-Voltage, Low-Current LEDs measure 38 mm in diameter and feature a 120° viewing angle. They are available in standard cool and warm white as well as custom colors. The technology is competitively priced at \$10-\$15 per unit in production volumes, with lead times of 10 to 12 weeks. ■

New DC LED Light Engines from Thomas Research Products

Thomas Research Products is excited to introduce an advanced new line of DC LED Light Engines, offering OEM customers simple solutions for solid-state lighting. Thomas Research Products is a leading manufacturer of SSL power solutions.

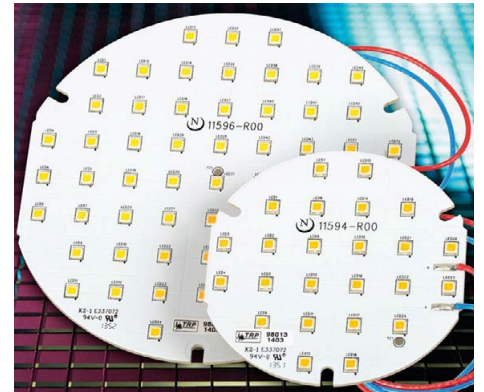

TRP's 8 new families of LED light engines aims to easily fit into a wide variety of existing luminaire designs

TRP's 8 new families of LED light engines are designed to be "standard," making them easy to simply drop into a wide variety of existing luminaire designs. Depending on the model, color temperature options range from 2700 K to 5000 K, most with 83 CRI or better. Offering high lumen output, they are optimized for use with TRP's high-performance LED drivers.

Linear 11" and 22" engines are engineered for troffer applications, whether retrofit or new manufacturing. A Narrow 22.7" linear model, perfect for cove, under cabinet and sign lighting applications, can be cut to length.

Round 3", 3.7" and 4.7" diameter light engines are available for commercial or residential downlight applications. A square 10.2" fingerboard design eliminates excess FR4 board, and provides superior light uniformity for surface-mount, recessed or suspended office luminaires.

Completing the range is a new rectangular 7" canopy light engine, designed for popular outdoor applications such as garage lighting, area lighting and gas station lighting.

Development was done in collaboration with the sister company, Norlux, a leading North American LED systems integrator with a history of strength in both design and manufacturing custom LED solutions. These new DC light engine products complement TRP's AC LED light engine offerings and comprehensive DC-based LED Driver line. Availability begins during 1Q 2014. ■

Konica Minolta Announces Flexible and Color-Tunable OLEDs

Konica Minolta will be showcasing its latest breakthrough technologies at Light +Building 2014, the world's largest trade show for lighting and architecture, held in Frankfurt, Germany, from March 30. The company will exhibit demonstration models using flexible OLED (Organic Light Emitting Diode) lighting panel prototypes with two unique features: the world's first color tunable function and the world's thinnest form factor.

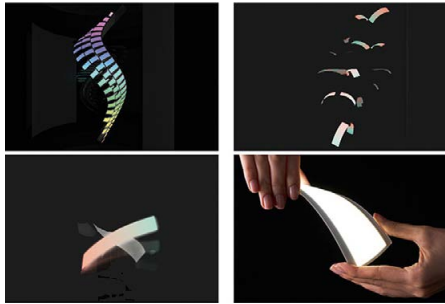

From top left to bottom right: Color-tunable OLED models Irodori, Ibuki, Habataki 2.0, and a demonstration of the OLEDs flexibility

Konica Minolta has been vigorously driving research and development and marketing activities for OLED lighting as one of most promising new businesses. The company's unique core technologies are most effectively utilized in delivering OLED lighting as environmentally responsible and energy-saving products. Over the years Konica Minolta has shown industry-leading achievements, including the world's first commercialization of OLED lighting panels using all phosphorescent emitters (October 2011) and the flexible OLED lighting demonstration model at the 2013 Lighting Fair (March 2013).

Capitalizing on its unique filmmaking technology, Konica Minolta has successfully developed flexible panels with new additional values: color tunable function and super thinness.

The panels will be the highlights of Konica Minolta at Light+Building 2014. The booth will be designed with a "cradle of light" concept: a place where OLED lighting is born and grown and plays the principal role in a new culture of light. ■

GLT Introduces New Light Guide with Different Bi-Polar Emission Pattern

Global Lighting Technologies (GLT), the world leader in edge-lit, LED-based light guides for general illumination, has introduced a new light guide that produces distinct customized emission patterns of light from the top and bottom surface.

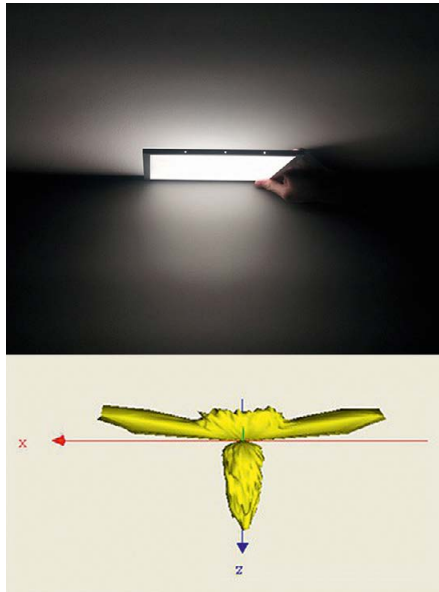

GLT can produce a light guide that will produce "batwing" distribution in an upward direction while maintaining more direct distribution in a downward direction

This enables lighting fixtures to emit light upward and downward using a single light guide with LEDs on one or two edges, while varying the distribution pattern from top to bottom. As demonstrated in the images and polar plot, one such option is a light guide that will produce a "batwing" distribution in the upward direction, while maintaining a more direct distribution in the downward direction. This distribution would allow proper illumination of a table or desk below the light guide while, at the same time, allowing the indirect lighting of the room from the upward distribution. Other options include more Lambertian distributions downward for more diffuse lighting as well as varying output angles for the upward distribution.

GLT can also design custom light guide assemblies in a "cartridge" format based on a customer's specific requirements, allowing them to be used as a standardized light source in a variety of fixtures. ■



KONICA MINOLTA

Illuminance Spectrophotometer CL-500A



- ➔ Evaluation of LED, OLED and other new-generation lamps
- ➔ Measurement of colour rendering indexes (R_a as well as R1 to R15)
- ➔ Included Software (Excel Add-In)
- ➔ On-site measurement and storing of up to 100 records

www.konicaminolta.eu

We're looking forward meeting you at the Light+Building 2014 in the Hall 4.1 booth J89!

PRIMESYM - Alanod's Easier and Quicker System Approach

At Light+Building 2014, ALANOD® will launch PRIMESYM, a completely new composite for LED luminaires which enables luminaire manufacturers to greatly simplify their production processes. An innovative combination of reflector sheets and conductor paths will make it possible to mount LED modules onto pre-manufactured reflector sheet carrier plates easily and quickly. The reflector is made of high-quality material from Alanod.

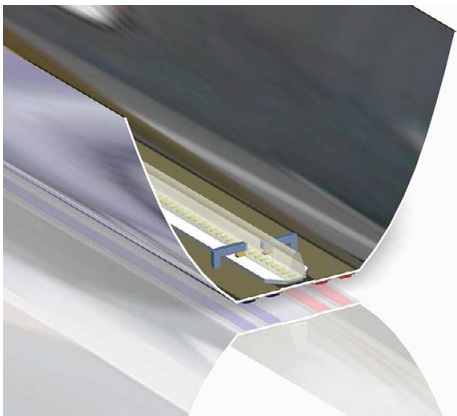

For luminaire manufacturers PRIMESYM means a more streamlined production process and fewer components. LED luminaires can be designed and produced more easily and more quickly

LED luminaires are simplified

Due to the electronic components used, LED luminaire design is highly complex. That's where Alanod's expert team came in and started to search for ways to simplify the design and make production more streamlined. The result is PRIMESYM where conductor paths are attached to an aluminum sheet equipped with a reflector surface in a patented process. The conductor paths are permanently combined with a thermally stable thermoplastic adhesive film that also serves as an insulator.

Subsequently, the raw material can be processed like a normal reflector sheet. PRIMESYM's modular structure enables further customized conductor paths to be added, which can then be used as control lines. It is possible for luminaire systems that are structured this way to be VDE approved. The manufacturer can then continue to use familiar production processes, and

PRIMESYM can be stored as bulk stock until final production. What's more, fewer parts and components are involved in the production process.

Alanod's expert team has also created solutions for adding heat sinks, though the aluminum sheet in itself guarantees very good heat dissipation. At the same time, Alanod's expertise in surface technology also means high quality for the manufacturer. With proven surfaces such as MIRO® and MIRO-SILVER®, high efficiency of the entire system as well as reliable light guiding and glare reduction can be achieved. ■

Khatod: New Series of Luna Optical Diffusers

Through the continual exploration of new areas of application for LED Technology, Khatod is proud to introduce new innovative, and appealing products for its customers. Luna optical diffusers apply and implement the new photoluminescence technology based on aluminates, inorganic materials, for new frontiers of design. Based on the photoluminescence technology, Luna optical diffusers can be used in a variety of applications. They are perfect wherever a uniform soft light is required, while offering the exclusive property of glowing in the dark even when the lighting fixture hosting Luna is switched off.

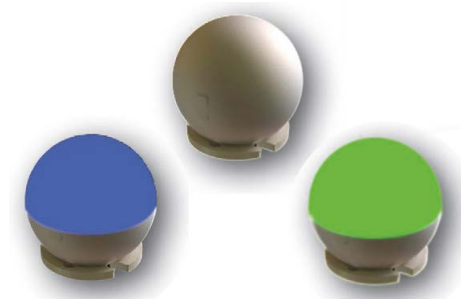

Luna optical diffusers apply and implement the new Photoluminescence Technology based on aluminates, inorganic materials, for new frontiers of design

Applications:

- Any application in General Lighting, Indoor and Outdoor
- Step-marker
- Signaling lamps
- Architectural lighting
- Any applications where a diffused soft lighting is requested

How does Luna actually glow-in-the-dark?

- LED in off position in daylight: Charging the Aluminates
- Luna's photoluminescent crystals absorb and store the light energy from ambient daylight
- LED in on position in daylight or in darkness: Lighting, and charging the Aluminates

Luna illuminates the environment while the LED light charges the photoluminescent crystals:

- High diffusion flux
- High luminous intensity
- Perfect uniform light distribution

In darkness, Luna crystals re-emit the stored light energy by emitting a luminous light over six/eight hours, by gradually decreasing in intensity. Recharge Luna in daylight or by switching on the LED.

- The soft light is diffused with a green respectively blue flux
- Perfect uniform light distribution

The photoluminescence technology is based on phosphors derived from natural non-radioactive toxic-free and harmless rare earth mineral crystals that possess the unique capacity to absorb and store light energy from ambient light, natural or artificial. In darkness, the crystals begin to emit a luminous glow by releasing the stored light energy over a length of time, up to six/eight hours, by gradually decreasing in intensity.

The crystals or pigments used for the photoluminescent properties of Luna, are selected and REACH Certified pigments. The presence of heavy metals is far below the statutory limits according to the European and American standards for safety regulations covering products falling in high safety categories such as cosmetics and toys.

The photoluminescence is a clean and renewable energy source, totally safe and harmless to the environment and humans. Its characteristics remain unchanged for years. The photoluminescent pigments used for Luna are explosion proof, vapor proof, non-radioactive, non-toxic and environmentally friendly.

Luna optical diffusers are provided with special adaptors, customized for the individual models of the major HB COB LEDs. The adaptors allow for the interchangeability of the Luna models on

the same LED source. The assembly method is unique and easy to use. No soldering or gluing is required. They allow immediate easy assembling of the diffuser onto the COB LED by a simple twist & lock system. ■

Vossloh Schwabe Provides LED Heatsink Based on Thermoplastics

Lightweight, efficient, environmentally friendly, and cost-effective; above all, deeply innovative. That is how the new heat sinks for LED lighting systems developed by Vossloh Schwabe using LATICONHER® 62 GR/50, a specially designed material from LATI, could be described.



Vossloh Schwabe's thermoplastics LED heat sinks are described as lightweight, efficient, environmentally friendly, and cost-effective

This PA6-based thermally conductive grade allows effective cooling of electronic components and LEDs thanks to a special graphite added to the compound in a quantity of 50% by weight, and featuring a structure that allows preferential heat transfer paths.

The base resin was chosen in cooperation with Vossloh Schwabe, bearing in mind that the primary objective is the proper and smooth filling of mold cavities operating under non-extreme conversion conditions.

After molding process tuning, the geometry of the items was also fine-tuned to ensure high dimensional stability needed for a safe assembly of the radiating element on LED electronics and relevant lenses.

The collaboration between Vossloh Schwabe and LATI resulted in a family of heat sinks of various shapes, sizes and applications.

In fact, heat sinks made of thermally conductive resin are used in modular projects meant to replace conventional halogen or FL lamps for public, corporate, commercial or domestic use (residential or furniture).

The shape and efficiency of the radiating system are carefully calibrated depending on the number of LEDs used and the power of the single device (up to 700 mA each).

Spotlights as well as real solutions designed for direct operation with 230 V mains voltage are contained in the Vossloh Schwabe catalog.

The use of injection molded thermoconductive resins allows for obtaining even very complex shapes and high dimensional accuracy, thus making the assembly process of finished product more efficient.

The chosen compound is among the most performant of the LATICONHER® family due to a thermal conductivity of about 10 W/mK, of course lower than that of aluminum, but sufficient for a specially configured solution.

Processing conditions involve temperatures of molten polymer well below those of metal, longer life of the molds and almost no processing after the molding.

These factors allow obtaining an interesting solution not only from a technical point of view, but also in terms of economy. ■

Supertex's HV9805 LED Driver Delivers True DC Current

Supertex, a recognized leader in high voltage analog and mixed signal integrated circuits (ICs), introduced the HV9805, an LED driver IC, where the LED light source is arranged as a high voltage LED string in order to accommodate certain lamp form factors, while allowing for cost savings through less complicated cooling and optical arrangements. The driver includes a linear post regulator to provide a pure DC current drive, for flicker free light output. The linear post regulator also provides protection from line voltage transients.

HV9805 supports a simple and low cost driver circuit, which combines a PFC boost stage and a linear post regulator for regulating the LED

current to a DC value. The boost stage employs the boundary conduction mode, with the output regulated for lowest overhead voltage at the linear regulator. The headroom voltage can be freely selected to optimize the efficiency of the post regulator or to minimize the cost or size of the bus capacitor.

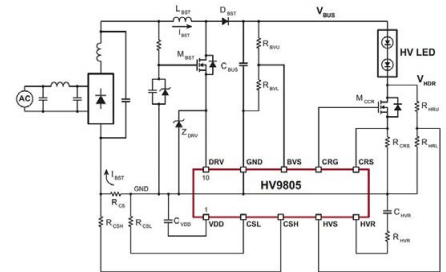

Typical application circuit with Supertex's new HV9805 LED driver IC

The boost converter employs a cascode switch for high-speed switching and convenient generation of the housekeeping (VDD) supply. The low voltage device of the cascode switch is integral to the HV9805 and is rated at a current of 1A. VDD power is derived with high efficiency and without the need for extra components or magnetic windings. ■

Marvell's New LED Controller for Unparalleled Dimming Performance

Marvell announced the Marvell® 88EM8187 LED Controller Integrated Circuit (IC) Series, phase-cut, deep dimming, single-stage AC/DC constant current controller for dimmable LED lamps and fixtures. This second generation LED driver IC builds on the industry leading, 88EM8183 by using unique mixed-signal architecture with on-chip advanced digital algorithms.

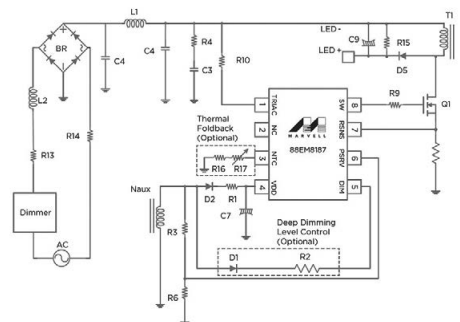

Typical application circuit diagram for a non-isolated phase-cut dimmable single-stage buck-boost LED driver using the 88EM8187

Key benefits of the Marvell 88EM8187 driver IC product line include:

Premium dimming performance:

- 100 percent worldwide dimmer compatibility including leading edge, trailing edge and special (Smart) dimmers
- Flicker-free, shimmer-less deep dimming as low as 1 percent

Reduced system BOM cost with fewer and smaller components in EMI/damping/dimmer level control circuit:

- Up to 25 percent cost savings over competing single-stage driver solutions

Integrated thermal fold back feature and optimized dimmer latch-up and hold-up current management:

- Removes heat from power components or "hot spots" dramatically improving reliability
- Removes potting requirement for further cost reduction

Highest driver electrical performance:

- Up to 90 percent driver efficiency
- Industry-best line regulation over wide AC voltage range (< 2 percent)
- > 0.95 Power Factor

The 88EM8187 product line delivers unparalleled performance with full compatibility to more than 250 dimmers worldwide, shimmer-less and flicker-free dimming as low as 1 percent, longer bulb lifetime due to superior thermal management and power efficiency of 90 percent, while significantly reducing electronic component count and total solution cost. A key component of verifying this unparalleled dimming performance was the collaborative testing of pre-release versions of the IC with lighting control leader Lutron Electronics Co., Inc. The 88EM8187 is also part of Marvell's Internet of Things (IoT) Smart Home lighting portfolio, offering a total solution for connected smart lighting applications. Marvell is currently sampling 88EM8187 to major LED lighting OEMs and ODMs around the world. Customers are expected to ship products based on the 88EM8187 this year.

The 88EM8187 raises the performance bar for the entire industry as consumers can now get the true incandescent experience that includes excellent dimming performance along with the energy savings provided by LEDs. The 88EM8187 and its unique digital architecture deliver the best performance in the industry at the lowest system cost by excelling in compatibility, reliability, efficiency,

deep-dimming level, and low component count without forcing OEMs to compromise their hardware designs. ■

IR's IRS2983 LEDrivIR™ Simplifies Design and Reduces Part Count

International Rectifier has introduced the IRS2983 control IC for single stage Flyback and Buck-Boost topologies used in LED drivers and power supplies. The IRS2983 employs primary side regulation that reduces component count and simplifies design by eliminating the opto-isolator and other components necessary for isolated feedback for fixed loads. The device also features a rapid startup circuit that drastically reduces the turn on time of the system.



The IRS2983 is a fully integrated, fully protected SMPS control IC designed to drive Flyback converter LED drivers

Features:

- Flyback LED Driver
- Critical-conduction / Transition mode operation
- Primary constant power control
- Burst mode operation at light load
- Over-current protection
- Micropower startup (150 μ A)
- Low quiescent current (2.5 mA)
- Latch immunity and ESD protection
- Open load over voltage protection
- Noise immunity

The new device also offers high power factor and low THD and operates over a wide input range for many LED lighting applications. Comprehensive protection features including hiccup mode over-voltage protection, cycle-by-cycle over-current protection and open and short circuit protection are also included. The device also supports TRIAC dimming.

As traditional incandescent, halogen, and CFL light sources are rapidly being replaced by LED bulbs, tubes and fixtures, the Flyback converter is the preferred power supply topology for a large segment of the LED driver market. Flyback LED drivers are simple, cost effective and efficient. IR's IRS2983 helps simplify the design process and reduce part count and can also be configured to work with TRIAC dimmers.

Other key features of the IRS2983 include critical-conduction mode operation, with discontinuous and burst modes at light load as well as flexibility allowing easy connection opto-isolated feedback circuitry for more complex designs.

Available in an SO-8 package, the IRS2983 utilizes IR's advanced high-voltage IC process to deliver superior protection from electrical over-stress also offering micro-power startup, low quiescent current, latch immunity and ESD protection and noise immunity. ■

Acuity Brands Begins Production of eldoLED ECOdrive

Acuity Brands, Inc., a market leader in innovative energy-efficient lighting solutions, announced the introduction of the ECOdrive® family of LED drivers from eldoLED® and its launch to the OEM market. The driver family is manufactured on newly expanded high-speed surface mount technology (SMT) lines that can easily support production of more than 1 million LED drivers and 5 million LED boards.



The ECOdrive® family from eldoLED® consists of intelligent, easy-to-configure, high-volume LED drivers

The ECOdrive family consists of intelligent, easy-to-configure, high-volume LED drivers for commercial indoor LED lighting applications. These drivers deliver unparalleled performance in an industry



New Product | Multi Lens

18 in 1



LL18NI-BEBxxL02

DxH(mm)73.4x8.5
FWHM 25° 40°
For Nichia 757



PAR38

13 in 1



LL13NI-BEBxxL02

DxH(mm)62x8.5
FWHM 25° 40°
For Nichia 757



PAR30

8 in 1

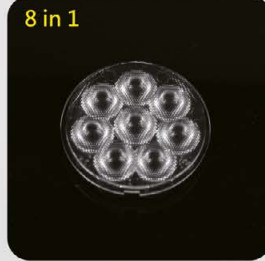

LL08NI-BEBxxL02

DxH(mm)43x8.5
FWHM 25° 40°
For Nichia 757



PAR20

5 in 1



LL05CR-BFRxxL06

DxH(mm)35.8x6.3
FWHM 25° 40° 60°
For CREE XT-E
Nichia 757/ NVS19B



MR16

4 in 1

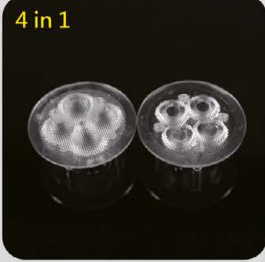

LL04NI-DOxxL06

DxH(mm)35x10.5
FWHM 25° 40°
For Nichia 757



MR16

3 in 1



LL03CR-ARIxxL06

DxH(mm)35x7.9
FWHM 38°
For CREE XT-E



MR16

3 in 1



LL03CR-ARHxxL06

DxH(mm)21.8x7.9
FWHM 38°
For CREE XT-E



MR16

Our Services



- ▶ R & D ▶ Precision Mould ▶ Manufacture ▶ Component solution
- ▶ Customerization

Further technical information is available, please contact us for more details.

standard footprint, offering ultra-smooth 1% dimming, wide-range programmable output and flicker-free performance in various form factors.

By strengthening internal design and manufacturing capabilities, Acuity Brands can now provide rapid prototyping iterations as a service for its OEM customers. These investments will allow the company to deliver innovative electronic components to its customers at a faster pace. "We are excited about the ECOdrive being an integral part of Acuity Brands lighting solutions, and even more excited about the value it offers to our OEM partners," said Gilles Abrahamse, Vice President and General Manager of eldoLED, a division of Acuity Brands Lighting. ■

GlacialLight Introduces DALI Interface Converter

GlacialLight, a division of the Taiwanese technology manufacturer GlacialTech Inc., is introducing the GL-DA02 DALI interface converter to its product lineup. The GL-DA02 converts international DALI standard to a full range of analog dimming signals for flexible and precise indoor lighting control.

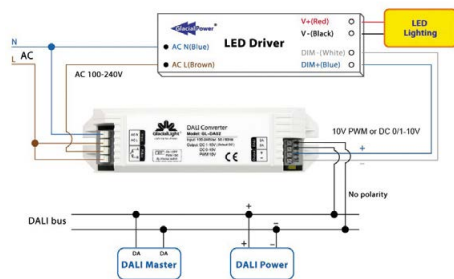

GlacialLight's GL-DA02 converts international DALI standard signals to PWM-10V, DC 0-10V or DC 1-10V dimming signals

Features:

- Compliance with DALI standard (IEC62386 Part 102 & Part 206)
- DALI signal is polarity insensitive
- Screw-less connector, easy to install
- Selectable dimming output: PWM-10 V / DC 0-10 V / DC 1-10 V
- Selectable dimming curve: logarithm or linear
- Build-in Relay to turn ON/OFF driver completely
- 3 year warranty

As an open standard, DALI is internally recognized as the premier new lighting control interface and is cross-compatible across lighting components from different manufacturers. Highly scalable, it simplifies wiring compared to conventional lighting control systems, making installation easier and reducing maintenance costs. DALI can not only control lighting but also monitor it, allowing for intelligent lighting systems that maximize service life and save energy. Compared to legacy solutions, a DALI network is more precise and allows fine grain control over the individual components in a complete lighting system.

GlacialLight's DALI Interface Converter is fully IEC62386 (102, 206) compliant. Taking a digital DALI signal, it can output PWM, 0-10V DC, or 1-10V DC signals and is suitable for controlling 3-in-1 (DC/PWM/Resistor) LED drivers. Dimming can be set on a linear or logarithmic curve. With a built-in relay, devices down the line can be turned off completely, giving complete lighting control and reducing energy costs.

As an indoor digital lighting control system, the GL-DA02 convertor is well suited for applications including office buildings, conference rooms, factories, and intelligent home lighting. ■

New Everline LED Drivers and Modules

Universal Lighting Technologies, Inc. recently announced the launch of its latest generation of high efficiency LED drivers and linear modules as an expansion of the Everline family of lighting products. The new Zhaga and Zhaga-Hybrid LED modules and drivers will allow for easier installation of full featured, high-efficiency linear LED lighting systems with flexibility in multiple applications.



Universal Lighting Technologies' new drivers offer a very broad range of adjustable output currents

From 1x2 troffers to highbay lighting fixtures, the Everline driver and module(s) configurations produce outputs from 1,000 to 10,000 lumens at efficacies far superior to any fluorescent systems. The LED modules are available in 11", 22" and 23" overall lengths with different LED counts to provide additional lumen and efficiency options. The LED drivers, with tunable constant currents, are available with 30W, 55W, 80W and 90W power outputs.

Additional benefits of the new products include high quality color and an exceedingly long rated life. Outfitted with a tuning feature, the Everline LED driver allows fixture manufacturers to design to specific target lumen levels by programming the driver's output current. Analog dimming affords the end-user with controllable options to manage energy and lighting levels.

In fact, at the start of the year, Universal Lighting Technologies, Inc. relocated corporate office facilities and utilized these new LED technologies in troffer luminaires as well as downlights that incorporate Everline LED Drivers and Chip on Board LED Modules with dimming controls. ■

New Recom LED Driver Solutions

Recom Lighting is launching two new high-power, dimmable, constant current LED driver series for applications that require a high output voltage to drive long LED strings and a new series of 45 W and 60 W LED drivers for constant current LED luminaires.



Recom's new dimmable RACD100 & RACD150 drivers are suitable for a broad range of input voltages, while offering highest efficiency output currents

RACD100 & RACD150 Drivers :

The RACD100A series offers constant output currents of 1400 mA or 700 mA at voltages from 50 V up to 142 V. The RACD150A offers constant output currents of 1400mA, 1050mA or 700 mA, but with voltages from 60 V up to 210 V. Both LED driver series support dimming via PWM or 1-10 V signals and are fully IP67 sealed for outdoor as well as indoor applications.

With their wide input voltage range of 90 to 305 VAC, the new drivers can be used worldwide on 115 VAC, 230 VAC and 277VAC supplies. The drivers operate with full load efficiencies of more than 93%, feature low THD (15%) and active PFC with power factors exceeding 0.98 and are fully protected against short circuit, overload and over temperature conditions.

Applications include high power area lighting as well as car parks, warehouse or security lighting. The LED drivers are UL8750 and EN61347 certified, comply with FCC and European EMC standards and come with a full 5 year warranty.

RACD45-A & RACD60-A Series:

The RACD45-A and RACD60-A series come with a 3-in-1 dimming function so that the modules can be controlled with analog, (1-10 V), PWM, or external resistor dimming. The series operate with input voltages between 90 VAC and 305 VAC and include 4 different models with current outputs ranging from 700 mA to 1850 mA (RACD45-A) and from 1050 mA to 4200 mA (RACD60-A).

Due to their IP67-rated enclosures, these drivers are protected against dust and moisture so they can be installed in industrial or out-buildings as well as damp rooms like bathrooms or basements. These class 2 power supplies operate at temperatures ranging from -30°C up to 65°C, have efficiencies of more than 87% and feature low THD and an excellent power factor (>0.98 at 120 VAC, >0.93 at 240 VAC and >0.9 at 277 VAC). The modules are fully protected against short circuit, overvoltage, and over temperature. ■

Xenerqi Releases the New XEL-A020A HP Puck Driver

Xenerqi Limited releases its newest Puck, the XEL-A020A, Universal input, Triac Dimmable, 18W 68mm Puck. This next generation of Xenerqi's revolutionary down light driver provides the same unsurpassed dimming, thermal and drive consistency available in XEL-012CA family but at a significantly higher power level.

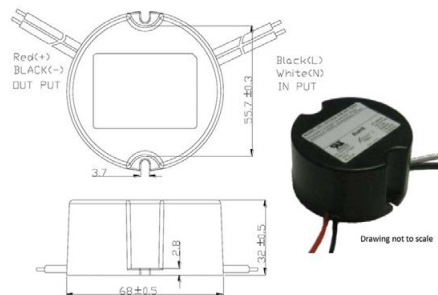

Xenerqi's XEL-A020A Puck enables higher power down light and recessed applications while maintaining the industry's best TRIAC dimming compatibility

The XEL-A020A Puck comes in the same shape of our original puck and with an industry-leading diameter of just 68 mm, which still has an easy-to-deploy UL 5VA rating. This new high power puck enables higher power down light and recessed applications while maintaining the industry's best TRIAC dimming compatibility, along with the robustness to meet the environmental stresses that exist in its target applications.

This driver series comes with Xenerqi's standard 5 year warranty and is an ideal candidate for applications requiring Energy Star certifications. The XEL-A020A is a constant current driver with output currents in in the 350 mA ~ 1250 mA range. This driver family is also part of Xenerqi's "Custom Made Simple" program and customized variants with specific output currents or voltages can be created within a week.

This Xenerqi 18W driver series has undergone extensive compliance and certification testing. The products in this family are cUL 8750, FCC Part15/18 Class B compliant, meet Class A noise rating, comply to IP66 water and dust particle immunity, meet Energy Star guidelines, abide by ROHS, and have a standard 5 year warranty. ■

WHAT'S IN YOUR LED FIXTURE?

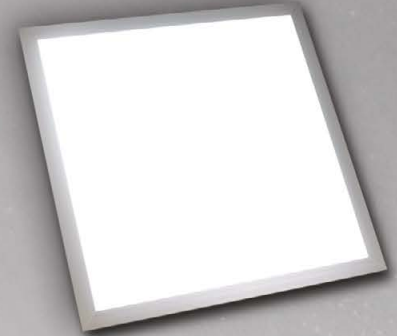

GLT LED light guides provide superior output & uniformity in your custom design.

- Fewer LEDs needed
- Custom sizes and shapes for ceiling, wall, cabinet, task lighting & more
- High volume manufacturing & fast turnaround

Put the power of GLT light guides in your fixture and see what a difference it makes.



Cleveland, USA • Taipei, Taiwan
440-922-4584 • sales@glthome.com
www.glthome.com

Mean Well Announces DALI to PWM Signal Converter - DAP 40

In response to the increasing demands of DALI control for LED lighting applications, MEAN WELL introduced the DALI to PWM converter DAP-04. Along with MEAN WELL's LED PSU equipped with "3-in-1" dimming function, this new product makes the DALI control possible on LED lighting fixtures. DAP-04 equipped with both DALI dimming and push-dim functions.



Mean Well's DAP-04 offers both DALI dimming and push-dim functions which makes it a very versatile controls tool

Features:

- 90~305VAC input range
- Convert DALI signal to PWM signal
- Built-in push-dim function
- 4 DALI addressable output channels
- Linear or logarithm dimming curve selectable (meet IEC62386-207)
- PWM active high or active low selectable
- Dimming range: 1~100%
- Class II power unit, no FG
- Power consumption<0.5W
- Built-in relay contact for ON/ OFF control of LED PSU
- IP20 level
- Cooled by free air convection
- Working temperature: -30~+60°C
- Fully isolated plastic case
- Meet DALI standards (IEC62386-101,102,207)
- Certificates: EN61347-1, EN61347-2-11, EN61058-1
- 3 years warranty

When connecting to the external DALI controller, it can convert the DALI signal transmitted from the controller to PWM signal, and then the PWM signal can control the lighting fixtures through the "3-in-1 dimming" interface. Similarly, by adding the external

push dimmer, the output PWM signal also can adjust the LED output current according to the different press time of dimmer. Each output channel of DAP-04 can connect with the dimming control input of MEAN WELL's LED PSU for up to 20 units, which means the 4 output channels on the converter can connect with a total of up to 80 units. Each channel has an independent DALI address and can be controlled separately, which greatly fulfill the demands of intelligent lighting control system that require energy-saving, high efficiency, and flexibility.

Featuring 90~305 VAC input and power consumption <0.5 W, DAP-04, it can be cooled by free air convection from -30°C to +60°C ambient temperature that is required for operating in a closed system. Enclosed by UL 94V-0 rated plastic case and Class II double isolation design (without FG), these units can effectively prevent users from receiving an electrical shock. The I/O terminals are designed with screw-less clamp style terminal block, which allows users a more convenient wiring installation. Other standard functions include built-in relay contact for ON/OFF control of LED PSU. DAP-04 should be used with MEAN WELL's AC/DC LED drivers which have 3-in-1 dimming function and is suitable for applications including household lighting, office lighting, and indoor decorative lighting that require DALI controlled operation. ■

Cree's SmartCast Technology Lighting Control Systems

Cree, Inc. introduces SmartCast™ Technology, the first self-programming wireless lighting-control system that reduces energy consumption by more than 70%, at half the cost of traditional lighting controls.

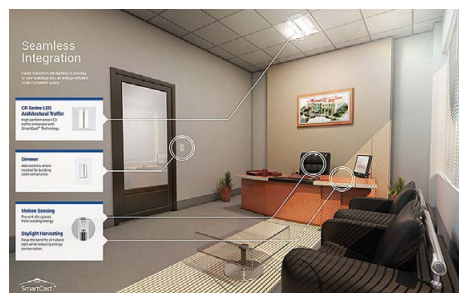

Cree SmartCast Technology is currently sold through Cree lighting sales channels throughout the United States and Canada

Intuitive and easy to use, luminaires enabled with Cree SmartCast Technology remove the initial and ongoing complexity associated with lighting controls, allowing customers to realize the full savings potential of lighting controls with benefits they've never had before.

Featuring Cree's innovative OneButton™ Setup, luminaires enabled with SmartCast Technology create their own secure network, learn about their environment and form groups to maximize savings, all with the push of a single button. SmartCast Technology eliminates additional design time, wires and set-up time often associated with controls systems to provide the simplest controls system available.

Cree SmartCast Technology is currently available in CR Series LED troffers, CS Series linear luminaires and KR Series downlights, as well as via a 0-10-volt interface for control of existing dimmable LED luminaires. These critical features not only save users energy and money but they are compliant with emerging code requirements throughout the United States and Canada. ■

NXP and EnOcean: Wireless Smart Lighting Network

At the 2014 International CES, NXP Semiconductors is demonstrating a wireless smart lighting network designed for ease of installation in the home. The demo includes an energy-harvesting switch (battery-less, no wires) developed by EnOcean, a world leader in energy harvesting wireless solutions. The switch uses the NXP JN5161 wireless microcontroller and implements the ZigBee® Green Power feature.



NXP's demonstrated smart lighting network at CES 2014 includes EnOcean's energy harvesting switch, RGB LEDs, and a bridge to the Internet of Things

Sensor Driven Lighting

www.ams.com/light-sensors

L+B booth H4.0/G22
Lightfair booth 7951

TSL4531 / TCS3472 – Digital ambient light sensor and RGB color sensor with IR filter

- Accurate measurements of ambient brightness and color in luminaries
- Photopically shaped response, approximates human eye response
- On chip A/D conversion with 16bit I²C interface
- Simple direct lux output and color readings
- Far superior solution compared to analog photodiodes

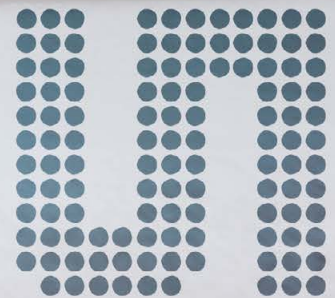

We provide innovative analog solutions to the most challenging applications in sensor and sensor interfaces, power management, and wireless.

Using NFC (Near Field Communication) technology, the EnOcean switch can be added to a home network simply by tapping an NFC-equipped mobile phone on the gateway to collect important network parameters, and then using the phone to pass them on to the switch. Designed by NXP, the gateway connects devices using ZigBee or JenNet-IP™ to the Internet via an existing home Wi-Fi router. The gateway simply plugs into the home router via an Ethernet port, and supports ZigBee Light Link, ZigBee Home Automation and JenNet-IP for wireless communication, as well as NFC for commissioning. Completing the demo are wireless color LEDs and tunable white dimmable LED lamps, which can also be added to the network using NFC and then controlled via an Android™ smartphone.

The reference design for the 802.15.4 to Ethernet bridge, which is based on the JN5168 wireless microcontroller, is available immediately. The RGB and tunable white LEDs, which offer very high brightness and color saturation, use NXP's patented sensorless sensing technology, first demonstrated at CES 2013. ■

opsira uku - The Flexible Integrating Sphere Series

The uku integrating spheres series enable the fast and easy setup for measurements of the radiant power and the luminous flux of light sources as well as the reflection, the diffuse reflection and transmission of materials.



uku is opsira's integrating spheres series. Here the uku 1000

The idea is simple, exact and flexible. The uku series concept is based on planar surfaces that allow adjusting any type of detector, light

source and material sample easily and without port adapters in a highly flexible way to the sphere ports.

A wide variety of accessories are available for the most flexible use possible. opsira offers various sizes of integrating spheres. ■

ASE Test Develops SSL Test System for Validation & Volume Manufacturing

ASE Test, a division of Automation South Electronics, has developed the industry's first automated test system that is specifically designed for quickly testing the electrical performance of LED drivers, LED arrays and LED fixtures. Designated the ASE SSL 3.0 Test System, this flexible test system can be used for design, design validation and volume manufacturing testing to verify quality of production. The SSL test system can also verify the electrical performance of incoming LED driver and LED array shipments, providing traceability and accountability within the supply chain.

Advanced testing and documentation features provide statistical process control (SPC) that enable manufacturers to meet six-sigma certification. In addition, the ASE SSL 3.0 Test System allows manufacturers to save on warranty claims because of the documentation and traceability of LED drivers used in production.



ASE's test system can be used to test LED luminaries with up to 300 VRMS (750VA maximum) or 425 VDC (575 W maximum)

The ASE SSL 3.0 Test System can rapidly test and verify single or multi-channel LED drivers, either constant current up to 20 A or constant voltage up to 500 VDC. The system can be configured and customized for the end user's requirements to optimize performance.

"In the solid state lighting industry, standards have not been established or defined for testing LED drivers, light engines or light systems. There is no attribute testing on volume manufacturing, no SPC on volume manufacturing, no parametrics, no empirical data, and no traceability. The ASE SSL 3.0 Test System efficiently provides automated production tests to deliver validation and verification of performance," said John Banks, president of Automation South Electronics.

Test results can be reviewed to monitor the performance of the system and the units under test using the provided results query window. SPC alarms can be set to alert the technician when selected test results are out of control. Manual operation allows the testing of units with different source and load conditions. This can be used for testing during design development and debugging of failed units.

A handheld or fixed barcode scanner can be added to the ASE SSL 3.0 Test System to allow for the entry of the unit identification into the operator interface for warranty tracking. ■

Cree Introduces New High-CRI LED Modules

The new 6000-lumen LMH2 LED module from Cree is the industry's brightest module to offer color-quality greater than 90 CRI at a consistent efficacy of 85 lumens per watt across a wide range of color temperatures (3000 K, 3500 K and 4000 K). The no-compromise LED solution is the ideal replacement for 100-watt ceramic-metal-halide lamps in high-ceiling applications, using 30 percent less power, lasting three times as long and delivering instant-on, dimmable light.



LMH2 LED modules from Cree are now also available as High-CRI versions

The Cree® LMH2 family of modules is the only light source that can address such a wide range of lighting applications in a common form factor. This allows lighting manufacturers to create an entire product portfolio with just one tooling set and one optical design. Lighting products based on the LMH2 LED module also enable lighting designers to illuminate a space with one light source and lighting technology, helping to eliminate the problems, such as color consistency and re-lamping, that come with using different lighting technologies.

Lighting manufacturers looking to shorten the time-to-market for their luminaire design can also take advantage of the LMD600, Cree's cost-effective, universal driver that is designed to power the new 6000-lumen LHM2. Dimmable to one percent, the LMD600 is optimized for a controllable, indoor architectural environment. The LMD600 can also handle up to 90°C case temperature and has a low-voltage, limited-energy-driver rating that does not require special enclosures or large-gauge wires, delivering design flexibility and a low system cost for lighting manufacturers. Cree also offers a range of reflectors and heat sinks, as well as a splice box for the entire LMH2 LED module family.

The complete LMH2 module family is available in a range of lumens (850 to 6000) and color temperatures (2700 K to 4000 K), delivering up to 108 lumens-per-watt efficacy and a CRI greater than 90. These lighting characteristics combined with multiple driver options, including digital-addressable lighting interface (DALI) and DALI® touch-dimming driver options, enable lighting manufacturers to expand their portfolio quickly and easily. Designed for 50,000 hours of operation, the LMH2 module comes with Cree's industry-leading five-year warranty. The LMH2 is also UL-recognized and complies with multiple international regulatory and safety standards. Luminaire makers seeking ENERGY STAR® qualification will have access to specification and performance data, including LM-80 reports, which can speed regulatory approvals. ■

HEICO lighting™ Launches Its Brand New Polyoptik™ Module

The Polyoptik™ is a unique and innovative LED module of only 3 inches long meant for the architectural lighting industry that will allow you to fine-tune your lighting design in every detail. It is the only LED module to offer as much in terms of flexibility with such a great quality guarantee.



HEICO lighting's Polyoptik™ is offered in many beam angles, delivering precise optic control

Characteristics:

- More than 90% efficiency
- Modular design to suit any project
- Patented induction power technology
- No polarity
- Rugged design, LED module is entirely encapsulated (IP67)
- 5-year warranty
- Corrosion-proof
- Designed and manufactured in North America
- Precise beam control

Applications:

The Polyoptik™ will enhance many of your applications by highlighting every architectural detail. You will be able to use it for gallery/museum lighting, wall washing, wall grazing, accent lighting, display lighting, cove lighting, retail store lighting, office lighting, jewelry store lighting, etc.

The Polyoptik™ is a unique North American LED module based on HEICO lighting™'s patented Contactless LED technology, an ultra-efficient power technology. Indeed, this Class 2 type module provides a uniform illumination with more than 90% energy efficiency and a high CRI. Its Contactless system, and its multiple options allow for a perfect personalization of your luminaire to your application, unheard of in the industry.

B MADE IN GERMANY.

AQUALUC®
BRAVING ALL ELEMENTS

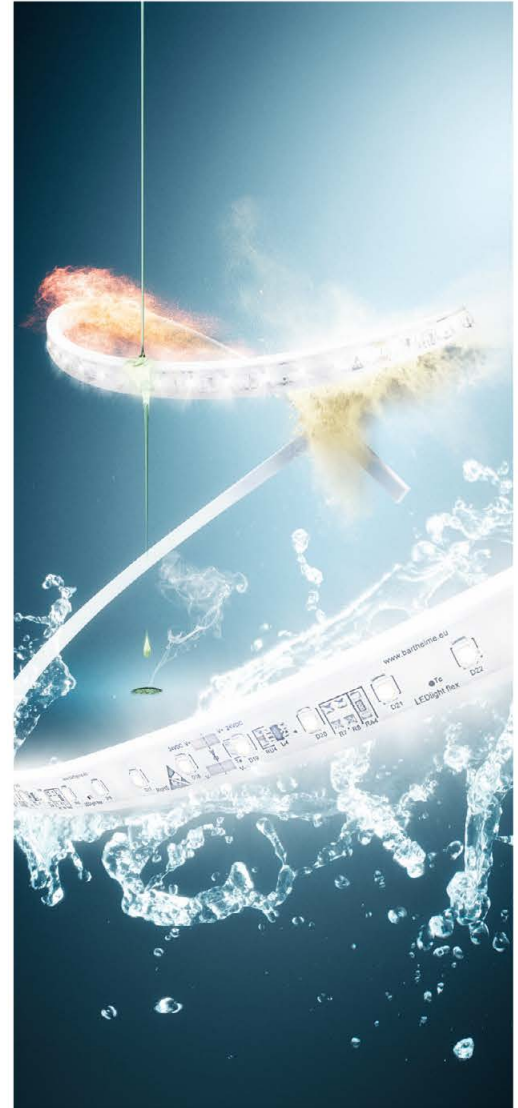

POLYURETHAN GROUTING FOR LED STRIPES

PROTECTS WELL AGAINST WATER, HEAT, SAND, SALT, CHEMICAL SUBSTANCES AND MECHANICAL STRESS

VARIOUS KINDS OF GROUTINGS FOR VARIOUS APPLICATIONS AVAILABLE

Barthelme
LED Solutions®

www.aqualuc.de

LIGHT + BUILDING
30.03. - 04.04.2014
MESSE FRANKFURT
HALLE 4.1 STAND A46

This product is offered in many beam angles (20°x20°, 40°x40°, 20°x40°, 180°x180°) and shades of white (3000 K and 3500 K).

Compatible with the Virgolite™ family modules, the Polyoptik™ modules can be installed alternately, allowing to mix various colors (white, amber, blue, red and green), light intensities and beam angles within a single LED system.

Its small size (3 inches) allows you to decide the length of your system up to an increment of 3 inches.

The result? Multiple Polyoptik™ perfectly selected for all needs create a HEICO lighting™ contactless LED system entirely customizable to fit many indoor or outdoor applications. ■

Soraa Introduces 4000 K & 5000 K CCT Full Visible Spectrum Vivid 2 MR16 LED Lamps

Soraa, the world leader in GaN on GaN™ LED technology, launched the world's first high color temperature (CCT), high color rendering MR16 LED lamps—a brilliant choice for gemstone jewelry and high-end retail displays. The new 4000K and 5000K CCT, full visible spectrum Soraa Vivid 2 LED MR16 renders colors and whites exactly as they would appear in natural light; without the high heat/UV emissions associated with CMH/halogen lamps and beam striations, artifacts or multiple shadows visible in other manufacturer's LED products.



Soraa's new Vivid 2 MR16 lamps are based on the same outstanding technology as their 2,700 K CCT siblings

In certain environments, higher correlated color temperature light is preferred because it helps create an engaging and energizing environment. However, because of their broken spectra, LED and CMH lighting products of 4,000K and 5,000K CCT create spaces that feel unnatural and cold. The Soraa Vivid 2 MR16 solves this trade-off by representing every visible color in the right proportion, resulting in scenes that feel energizing, yet warm and natural. The full visible spectrum emission of these LEDs results in a CRI of 95 and R9 greater than 90. Plus, the violet component of the spectrum makes whites stand out in their natural brightness and tint.

Soraa's LED lamps are available in 12V and line voltage configurations, as well as in a wide range of color temperatures (2,700K, 3,000K, 4,000K, and 5,000K) and beam angles (10°, 25°, 36°, and 60°), allowing lighting flexibility for any type of indoor or outdoor environment. This includes lighting suitable for smooth and textured fabrics, gold, diamonds, skin tones, and a broad array of other applications. The company's narrow 10° lamp works with its award-winning magnetic accessory SNAP System. With a simple magnetic attachment, beam shapes and color temperature can be modified, allowing endless design and display possibilities.

Soraa's LED lamps are compatible with a very wide range of dimmers, having been tested and characterized extensively through its Works with Soraa program. And the company's novel heatsink design and thermal management system allows its lamps to run cool and deliver efficient light intensity over a long period of time. ■

ALTLED® T8 Tubes New Option - Linear Fresnel Lens

To better serve ALT's customers, ALT has adopted the use of linear Fresnel lens for the ALTLED® T8 tube series. Fresnel lens has the ability to effectively collect and concentrate a significant portion of the lamp's overall light output and direct it as a tight beam. Alternatively they can be used to collimate a linear light source (such as a strip of LEDs).

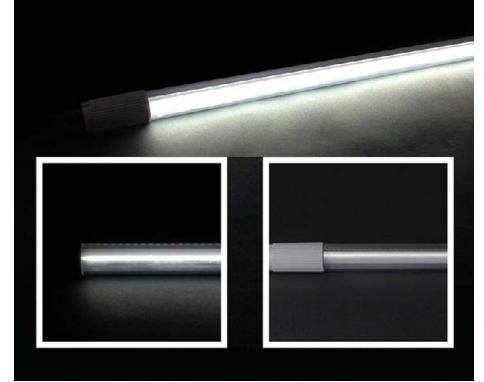

Besides the traditional clear, semi-frosted and frosted versions, ALTLED now offers a linear fresnel version of its T8 LED replacement tubes

Using the Fresnel lens for LED T8 tube with smaller chipsets has an advantage over frosted lens due to decreased loss of brightness. Most consumers do not like the visible chips in an LED T8 tube, thus manufacturers would either semi-frost or fully-frost the tube to cause a blurring effect of the chips, hoping to reduce the apparent LED chips within the tube. However, frosting the lens causes a lot of brightness to diminish. Alternatively, a Fresnel lens can capture more oblique light from a light source, thus allowing lesser light to become waste.

The effect of linear Fresnel lens is hardly the equivalent of conventional fluorescent T8 tubes, however its appearance is equally appealing as it creates a nice and clean line of directional light perfect for office or commercial usage. Furthermore, ALTLED's T8 tubes are non-flickering and together with the Fresnel lens it can also be non-glare. Therefore this new option provides customers the option to buy energy-saving LED T8 tubes without sacrificing aesthetics and safety. ■

DALI

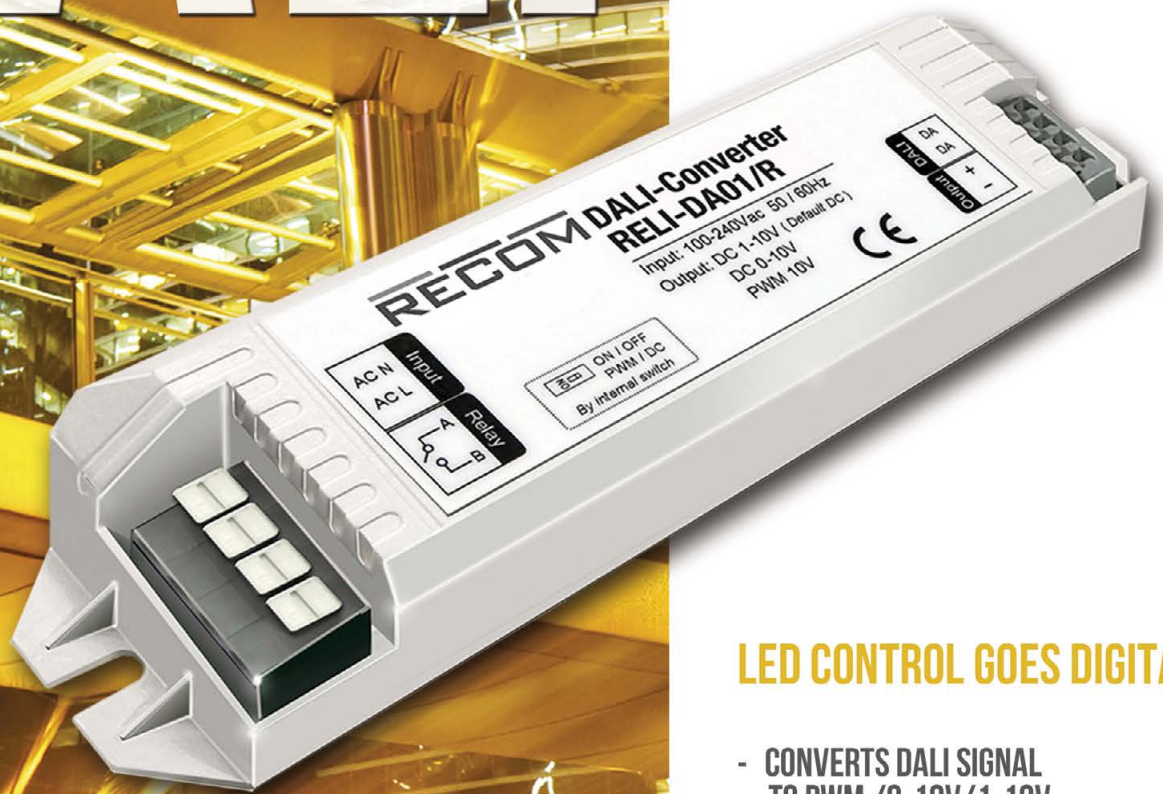

LED CONTROL GOES DIGITAL

- CONVERTS DALI SIGNAL TO PWM /0-10V/1-10V
- CONTROLS UP TO SIX DRIVERS WITH ONE DALI ADDRESS
- BUILT-IN RELAY FOR ZERO STANDBY CURRENT
- COMPATIBLE WITH ALL ANALOG OR PWM DIMMABLE LED DRIVERS
- COMPLIANT WITH DALI STANDARDS
- 5 YEAR WARRANTY

WWW.RECOM-LIGHTING.COM

CONVERTER

RECOM
LIGHTING

A Roadmap to Efficient Green-Blue-Ultraviolet LEDs

Scientists at the U.S. Naval Research Laboratory (NRL) have suggested a method that could significantly increase the efficiency of green-blue-ultraviolet light-emitting diodes based on GaInN/GaN, AlGaIn/GaN, and AlInN/GaN quantum wells. Their approach could enable advances in solid state lighting and the creation of low threshold lasers and high power light emitting diodes (LEDs). Their research is published in the January 25 and November 26, 2013 issues of Applied Physics Letters.

Epitaxial perfection in the growth of quantum wells has been the key to achieving light emitting and laser diodes of superior power, efficiency, and performance. Ternary group-III nitrides LEDs based on GaInN/GaN, AlGaIn/GaN, and AlInN/GaN quantum wells now find widespread application in energy-efficient as well as decorative solid-state lighting. But their use in high-power lighting applications is currently hindered by a significant loss in efficiency even at modest electrical currents. Indeed, the quantum efficiency of the LEDs peaks at relatively low currents - a few tens of amperes per square centimeter - and then steadily drops, by almost half, as the current increases. This "droop" in the efficiency is observed in the visible, blue, as well as ultraviolet spectral regions.

Scientists at NRL's Center for Computational Materials Science, in collaboration with researchers at the Technion, Israel, and Ioffe Physical-Technical Institute, Russia, have created computational models showing that the observed droop effect arises from non-radiative Auger recombination of the injected carriers. The rate of the Auger recombination is proportional to the cube of the carrier concentration. As a result, the non-radiative Auger decay rate grows rapidly with current density, quenching the generation of light.

To suppress these non-radiative Auger processes one needs to create quantum wells with a soft confinement potential. Dr. Alexander Efros, a senior researcher in NRL's Materials Science and Technology Division, previously showed theoretically that a softened electrostatic potential prevents carriers from acquiring the momentum necessary for non-radiative Auger processes, and thus suppresses the Auger decay rate. This concept was patented by NRL in March 2013. The latest calculations by the NRL-Technion-Ioffe research team demonstrate that softening the confinement potential - by varying the alloy composition along the growth direction - also completely suppresses the piezoelectric field that normally enhances non-radiative Auger processes in GaN/AlN QWs. The calculations show that the droop effect in such quantum wells can be significantly or even completely suppressed.

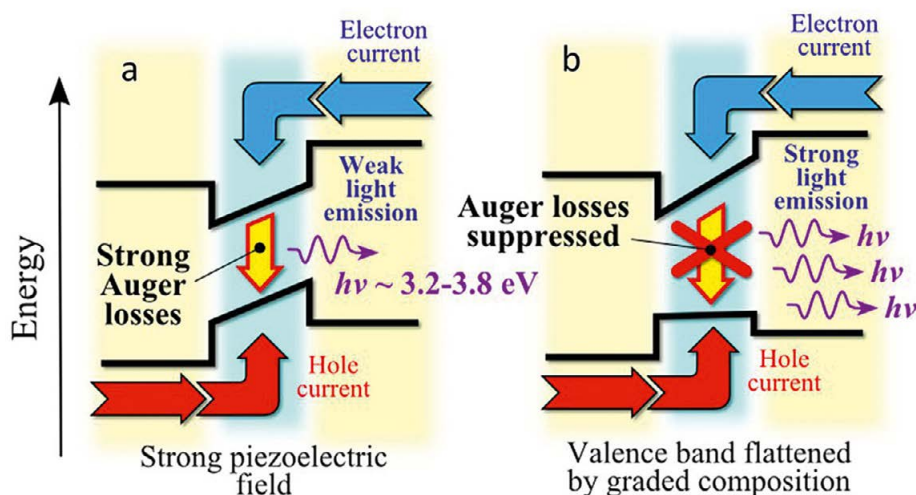

This is a schematic description of processes responsible for light emitting diode (LED) operation. The thick black lines show the energy band diagram of the conventional (a) and proposed (b) LEDs based on GaN/AlN QWs. In the conventional GaN/AlN QW LEDs the polarization field in the GaN layer enhances strongly the rate of the nonradiative Auger processes leading to reduction of the photoluminescence quantum yield and, consequently, to the "droop" effect with increase of the electrical current. In the proposed LEDs (b) the electric field acting on holes in the QW is compensated by a gradual composition variation of the variable-gap GaAlN alloy resulting in a flat valence band potential. The Auger processes in these QWs are completely suppressed and no droop effect is expected to be seen in such LEDs. (Credit: U.S. Naval Research Laboratory)

In addition to Dr. Efros at NRL, the members of the research team include Roman Vaxenburg and Efrat Lifshitz from the Israel Institute of Technology, Haifa, and Anna Rodina from the Ioffe Physical-Technical Institute, St. Petersburg. ■

WEBINARS



What's Next for Mid-Power LEDs in Lighting Applications

MP LEDs are uniquely suited for linear and distributed lighting applications such as LED tube lighting and troffers. MP LEDs are now gaining popularity for deployment in other lighting applications with specific needs which can be met when designed with the end application in mind. An example would be a high efficacy MP LED with good quality of light (min 90 CRI) for use in retail shops. K. Lee, M. Chang and D. Kane from Philips Lumileds will take a close look at MP LEDs, the factors that have led to their use in lighting applications and what we can expect in terms of their proposition and usage in the future.

To view the webinar, register at www.led-professional.com/webinar-1

PHILIPS
LUMILEDS



CREE® IS LED LIGHTING

versatile LED light.

As the developer of the first lighting-class LED, we're not scrambling to adapt to change; we are the change—and we won't stop until LED lighting is everywhere. Design in Cree LED modules and get one consistent light source with a choice of Sunset or WhiteLight dimming for applications ranging from intimate nooks to soaring atriums.

Cree makes light for living.



CREE LMH2 MODULES ARE BACKED BY 3RD-PARTY DRIVER COMPATIBILITY TESTING AND A 5-YEAR WARRANTY.



Visit cree.com/modules and learn how our full portfolio of LED modules can lower your system cost.

Visit Cree at L+B Hall 5.0, Booth C34 and at Lightfair Booth 5421

Quality and Sustainability Come First at Mexxotech

The Swiss company Mexxotech AG was one of the very first LED illuminant manufacturers. The main features of streetlights that were developed in the year 1999 can still be seen today and count as the most efficient. Aside from

numerous standard LED products, Mexxotech AG has decided to focus on special LED applications.

«SWISS MADE» stands for quality and sustainability. Mexxotech AG only

installs «single binnings» in all of their semiconductor products. The thermal behavior and the gentle operation of the LED are always in the foreground and therefore guarantee unprecedented quality and durability of the illuminant. ■

QUAZHAR® - The New High Performance from Mexxotech

Today Mexxotech AG is taking a new path and is bringing a new, innovative semiconductor product which goes by the name of QUAZHAR®-Board onto the market. Up until now, high performance spotlights with 120,000 lumens and more were either Halogen or gas discharge lamps.

With the new QUAZHAR®-Board, LED light performance of up to 180,000 lumens on an area of 140mm x 140mm can be achieved. At the same time, the board is only 5.5 mm thick. These high performance LEDs are operated with a maximum T_j temperature (measured directly on the LED) of 58° Celsius. The active cooling of the board is made possible by a revolutionary invention that has its origins in motor sports. This silent, maintenance-free module comes in 3 sizes. The board can also be manufactured in any size and diverse configurations by request. ■



Spectrum LED Boards – Medical, Food and Plant Lighting

Medical Technology

There are special application areas that exploit the spectral properties of the LEDs that are used. Some examples are medical systems where ultraviolet LEDs are used for polymerisation of plastics in dental technology and for light skin therapy, which is also known as LED photo rejuvenation.

High-quality light is required for operating room lights. It is important that the light does not heat up the operating area through IR radiation. By combining LEDs with different wavelengths, it is possible to optically highlight structures or alternatively veins or fat tissue.

Food

IR- and UV-free radiation protects food and reduces harmful heat generation. The freshness of the goods is optically highlighted through adjustable or programmable LED spotlights that are specifically designed for illumination of fresh produce such as fruit, vegetables, cheese, bread or meat. ■



Mexxotech AG
Landstrasse 2
CH-5436 Würenlos

www.mexxotech.com
Tel.: +41 56 511 77 90



Lextar

Lextar Electronics



Expert of Lighting Solutions

The largest LED lighting component
provider from Taiwan



SMD

3014 / 5630 /
3030 / 3030HV / 5050



COB

Nimbus Series

4W / 10W / 15W / 20W /
30W / 45W / 75W up to 120W

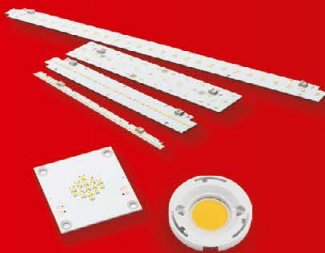

Light module

Vigor Series
Zhaga Book 3/ Book 7

1ft. (875 lm / 1450 lm)
2ft. (2590 lm)
2in. square (1280 lm)



Plug in COB

Core Series

7.5W / 13W

Lextar.com
Sales.LM@Lextar.com



Lighting Japan – Strong Focus on OLEDs

In contrast to many other lighting events, Lighting Japan tends to cover everything from material science to applications. In addition, the management's aim is to pick up on ongoing transitions in technology and market requirements faster than other events. Arno Grabher-Meyer from LED professional was in Tokyo and saw how this ambitious goal is achieved.

Over the past 10 years there has been a strong transition from traditional light sources to LED light sources. At the same time, LED lighting is also making a substantial transition to a mature product. Business models are gradually changing from being technology driven to becoming more application and market driven. Mr. Hajime Suzuki, the Director and Group VP of Lighting Japan explained it like this: "Our main goal is to provide high diversity and the highest quality exhibition and conference, and not quantitative growth at any price." He added, "Even at the beginning, when we started out as a technology focused event 6 years ago, we were aware of the fact that we might need to adapt the concept to serve the potential visitors and exhibitors in the best way possible. For this reason, this year, we dedicated the same amount of time for OLEDs in our conference as we did for LED topics. We also provided additional exhibition space for applications and design. There are now three areas: Design Lighting Tokyo, LED/OLED Lighting Expo and LED/OLED Lighting Technology Expo." The validity of this approach has been confirmed by the comprehensive approval of the attendees from all over the world.

From January 15th to 17th, Lighting Japan attracted a total number of 14,322 visitors of which 1,752 were VIP registrants and 38 special guests. Once again, the list of Opening Ribbon-cutting Dignitaries was chock full of top executives from almost all the major LED/OLED lighting manufacturers such as Toshiba Lighting, Toyoda Gosei, GE, Seoul Semiconductor, Philips Electronics, Osram, Cree, Everlight Electronics, Lextar, Epistar, Samsung or LG, to name just a few. A demonstration of how the show is becoming increasingly international were the Taiwanese, Korean and Chinese manufacturers and visitors who are showing more and more interest in Lighting Japan as the door to the Japanese market.

A Special Kind of Exhibition

While the management of Lighting Japan aims to fulfill all the demands put on a lighting show, they also worked very hard to give each of the three areas a special touch by providing several highlights. In the same manner as the conference, the Design Lighting Tokyo area, in particular, was characterized by a broad range of OLED highlights.

Design Lighting Tokyo

Visitors to the Design Lighting Tokyo exhibition got a good impression of the direction that OLED development is taking and which applications are seeing the greatest benefits from this technology. On the other hand,

existing limitations were also apparent. Besides unreasonable costs for mass production, restrictions on size are defining designs. In addition, the limited amount of light per area of most OLED modules plays a key role in determining the design and application possibilities.

While Lumiotec demonstrated its modules and a dainty luminaire design (Figure 1), Panasonic pursued a different approach with a straight forward technically designed OLED luminaire (Figure 2) which demonstrated the capabilities of their in-house developed and produced OLED modules. Hanyoung Eng. Co. Ltd. from Korea demonstrated OLED lighting with a pendant luminaire and their modular OLED desk luminaire (Figure 3). Blackbody (Figure 4), a very innovative OLED manufacturer was represented with its I.Rain, the latest OLED suspension designed by Thierry Gaugain, in the "Bridge", a zone where a collection of the simple, stylish and "NEXT" products by European lighting brands that have not been launched in Japan before, were shown. All luminaires in this area were selected by the well-known Japanese architect Akihisa Hirata. Another special zone, the Proto Lighting, was reserved for prototypes with exclusive design or technology. Here the visitors could find some of the most attractive, flamboyant, exclusive and technically interesting products. From a technical point of view the exhibits from Kenji Fukushima were most interesting. With a very clever, innovative, but basically simple solution, he transformed a rigid

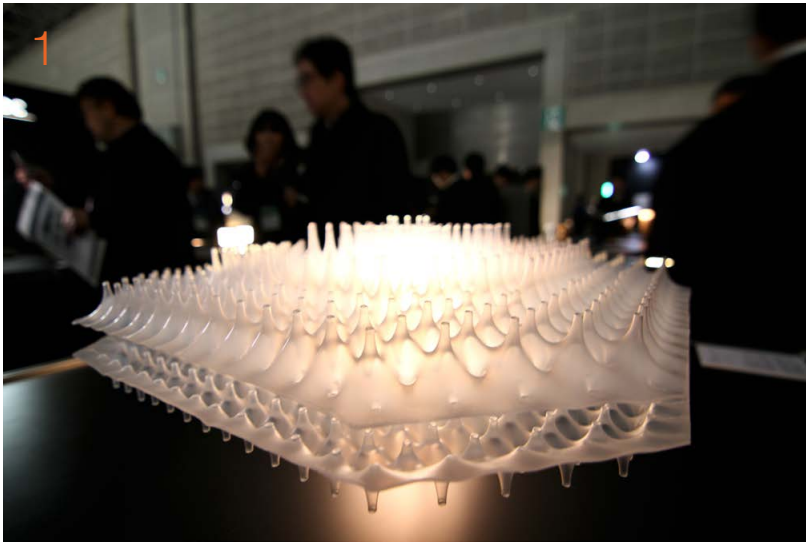

Figures 1 to 4:
Very different
OLED luminaire
concepts like
these ones
from Lumiotec,
Panasonic,
Hanyoung and
Blackbody gave
an idea of what
can be expected
when OLEDs hit
the mass market



Figure 5:
While the future of lighting is
often said to lie in flexible OLEDs,
intelligent structured acrylic sheets in
combination with LEDs are another existing
approach for 3-dimensional, smooth area
lighting products

Figure 6 (left):
LED:akarui demonstrated how AC driven LEDs with high efficiency allow for smaller heat sink designs of high output replacement lamps for high bay lighting

Figure 7 (right):
Smaller integrated chip cores for the NetLED Engine wireless solutions open new design possibilities



acrylic sheet into a thin and flexible light guide with areal light out-coupling that allows designs very similar to flexible OLEDs, but at this time much bigger areal dimensions. "Flexible acryl" (Figure 5) offers tremendous possibilities discovered by applying fine incisions in solid acrylic sheets. After numerous experiments and examinations involving various types, thickness and forms of acrylic sheets as well as patterns and spacing of incisions, he found a solution to create adjustable flexibility acrylic sheet. With its adjustable and flexible quality, this material provides limitless possibilities.

LED/OLED Light Expo

This part of the exhibition was mainly characterized by lamps for any socket and application from residential MR16 replacement lamps to HID replacements for street lighting, from high bay to tubes. Furthermore, luminaires and lighting systems covering drivers, supplies and controls were arranged in this section, where most of the foreign exhibitors were concentrated, namely in the Chinese pavilion, Korean pavilion, and the Taiwan pavilion. Some of the most important companies there were the area display and architectural lighting expert Optotech, driver and supply manufacturer Mean Well, LED, LED modules and luminaire manufacturer Edison Opto and the PCB specialist – offering UL certified COBs - USE Electronics, as well as high quality sensor specialist ams-TAOS from the US.

One of the most interesting focal points of this part of the exposition was the "Lighting Control System Zone". Here Taisei Corp and Lighting Systems showed their latest products with a clear focus on controls competency demonstrated by the broad range of opportunities from DALI to DMX, ZigBee and EnOcean. The company also proved their competency with a lecture from Nobusato Kobayashi from Taisei's design division and M&E planning department about "Latest Daylighting Technology and Lighting Control Technology". Their neighbor, ATEX, featured under their brand, LED:akarui, an AC LED based replacement solution for HID High Bay luminaires that combines high efficiency and luminous flux with low weight due to the eliminated driver and reduced heat sink design (Figure 6). Nearby, NetLED demonstrated its wireless controls system. A company spokesman claimed that their system offers better control opportunities, easier implementation and comparable efficiency than ZigBee Light Link does. He went on to explain that the NetLED Engine (Figure 7) uses the proprietary protocol LedBee™ which is based on IEEE 802.15.4. It is like ZigBee, but it offers multi-hop and is self-healing. It is a protocol optimized for lighting and sensors. NetLED offers a browser based management system for configuration, reconfiguration, scheduling, user management, and reporting.

LED/OLED Lighting Technology Expo

This technology focused exhibition was the most exciting section for our magazine. It was clearly dominated by domestic companies joined by some big LED manufacturers like Osram Opto Semiconductors, Philips Lumileds, Seoul Semiconductor, supplemented by IC manufacturer Power Integrations as well as innovative optics manufacturers Alanod, Almeco, and LedLink, all showing their latest products which can be easily found on the LED professional website. Listing and explaining the showcased product portfolio of these companies would clearly go beyond the scope of this report. Besides these big players, a huge number of internationally less well known and small companies were demonstrating very interesting products and innovative solutions. Therefore, only a few examples with unique products in the major technology fields can be shown.

Photal-Otsuka Electronics as a specialist for light measurement and testing introduced their latest and most innovative product, the high speed photo-goniometer system GP-7 (Figure 8). The main difference to any other currently available photo-goniometer lies in the software that allows measuring a light source not just in discrete steps, but in continuous motion of the measurement sensor/camera. The proprietary algorithm that precisely calculates the values and,



Make every customer more satisfied

LED & Lighting Measurement Solutions

EVERFINE is the only public company focusing on LED & lighting measurement instrument worldwide. EVERFINE provides all kinds of LED & lighting test and measurement solutions for laboratories, production lines and lighting fields with quality products and professional service.

MAIN PRODUCTS:

- Spectroradiometers
- Goniophotometers
- Thermal Analysis Systems for LEDs
- Aging-Life Test Systems for LEDs & LED Luminaires
- Photobiological Safety Test Systems



More www.everfine.net

EVERFINE Corporation (Stock code:300306)

Tel: +86 571 86698333 (30 lines) Fax: +86 571 86696433 E-mail: global@everfine.net Add: #669 Binkang Road, Binjiang National Hi-tech Park, Hangzhou, China

Professional PLCC Series Component

▶ High CRI Available ▶ Dimmable FPC Application



ET-3014



ET-3528



ET-5630

**light+
building**

3/30-4/4 Light+Building
Hall 4.2 Booth E91
Visit us !



by that, reduces the measurement time for a light source by 50-80% compared to a conventional system, is cost-effective and has low space requirements due to its design as near-field spectro-goniometer. It also offers multi-point surface luminance distribution measurement by a 2D CCD camera, measurement sample placement view by monitor simulation for accurate illuminance and luminance intensity calculation, and chromaticity distribution measurements.

APIC Yamada Corp., the most important and best known LED manufacturing equipment provider of the region, displayed their cost effective total packaging solution from lead frame design, molding and singulation, using the most advanced liquid transfer molding, compression molding, LED wafer level packaging, PKG dicing and phosphor coating technologies.

Ashai Rubber Inc. (ASA), demonstrated solutions for customized colors on demand and CCT adaptations, based on Nichia LEDs. The ASA Color LEDs (Figure 9) are produced by applying a phosphor impregnated, silicone rubber cap onto a blue LED. Because the attributes of a blue LED, such as wavelength and output vary, the optical properties of blue LEDs are classified by appropriate ranges. More than 100 standard caps suitable for each category are appropriately selected. The types and volumes of phosphor materials added to the caps are adjusted depending on each blue LED to control color tone homogeneously. For CCT adaptation, a very similar remote phosphor approach is available using Nichia's white LEDs. Both products aim to eliminate deviations in color and CCT. While the main application of ASA Color LEDs is in dashboards, this technology can also be beneficially applied in general lighting. A highly transparent silicone material that provides a light transmittance of 94% and optics made out of this UV and temperature resistant material completed the presentations of LED lighting.

Heraeus presented its Clevios™ for Hole Injection Layers (HILs), tailored materials for OLEDs as the layer between the anode and the organic layer stack. According to the company, the advantages are their reduction of the probability for electrical shorts by smoothing defects on the substrate's surface, and conductivity and high transparency. They also improve hole-injection into the OLED layer stack with high work function and form dipole layers at the interface. For LED lighting, they also demonstrated Clevios™ printable materials as an extension to their well-perceived thermal management products. To give visitors an idea of the options for design and functionality, they had demonstrators (Figure 10) for touch and lighting applications using the Etch and SET materials to establish active and non-conductive areas on a PET film.

Kyowa Sangyo featured very interesting Mekki-MEMS 3-D micro plating for MEMS technology; an ultra-precise plating method based on a thorough surface treatment. With their technology, the company can produce very precise structures while providing a layer thickness of several μm (Figure 11).

Nippon Electric Glass, a company dedicated to special types of glass demonstrated flexible glass products like the ultra-thin glass, G-Leaf, that achieved the film form with the excellent function and reliability that can be expected of glass. G-Leaf is a highly potential material for the next generation in the wide range of applications including lighting. The special version of G-Leaf with ITO coating by roll-to-roll processing has excellent gas barrier properties and achieves low sheet resistance. It is most suitable as substrates of OLEDs. Another product for OLEDs, the HX-1 extracts the light trapped in an OLED device when conventional glass substrates are used. Simply replacing conventional glass results in improved OLED lighting efficiency. The unique approach for manufacturing a glass-phosphor composite, Lumiphous (Figure 12), for LED

remote phosphor systems is said to create several benefits for LED luminaire manufacturers. This material has excellent heat, water and light resistance, and allows high power light emission with little color deviation.

Shin-Etsu Chemical also brought silicone materials for LED products to the show, but contrary to many other providers of silicone materials, their product line also covers LED packaging materials with a very thoroughly tuned assortment of products from phosphor blended silicone encapsulants to photo resist coatings and die-bond materials. They demonstrated their competency impressively with product samples from their clients. One example was an LED that had a very interesting arrangement of the dies (Figure 13) which could be seen when dimmed to a low light level. The company claims that their latest encapsulating materials have significantly reduced gas permeability over previous and competing materials. The result is a reduction in corrosion of peripheral materials that can lead to reduced light output over time and even premature failure. In addition to these materials, Shin-Etsu also offers silicones for lenses, exceeding 92% transmission, and reflectors that reflect light with a high efficiency of more than 98%.

IC manufacturer O2Micro showcased the newest driver ICs that simplify architecture and reduce the costs of LED lighting solutions. The concept is based on the usage of simple standard switches and can be applied for various products like LED bulbs and tubes, DC/DC products for MR16 bulbs, street lighting products, flashlight and bicycle light controllers. Different versions from three-step dimming ICs to continuous dimming versions and different power ranges are available. The continuous dimming ICs especially make costly TRIAC dimmers that often don't work properly with LED solutions, obsolete. Simply turn the light switch off and on again when the desired light level is reached, that's it.

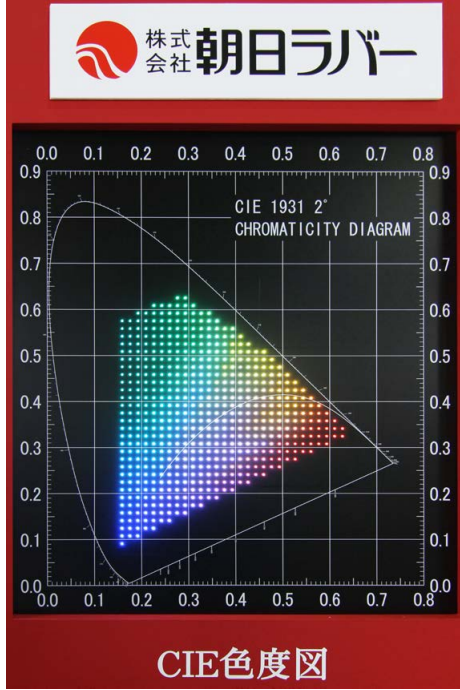

Figures 8 to 13:
 Test and manufacturing equipment as well as raw materials or semi finished products were demonstrated in various ways. From top left to bottom: Photal gonio-photometer, Ashai Rubber's ASA Color LEDs range, Heraeus Clevios™, Nippon Electric Glass' Lumiphous, and an LED using Shin-Etsu Chemical's silicones

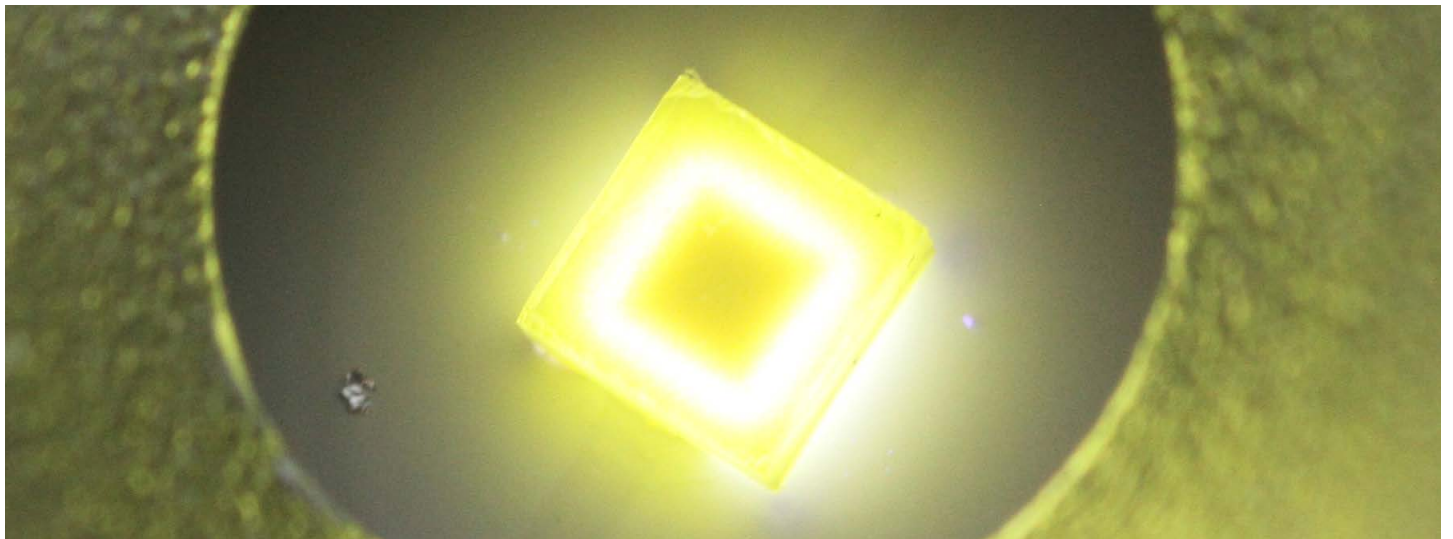
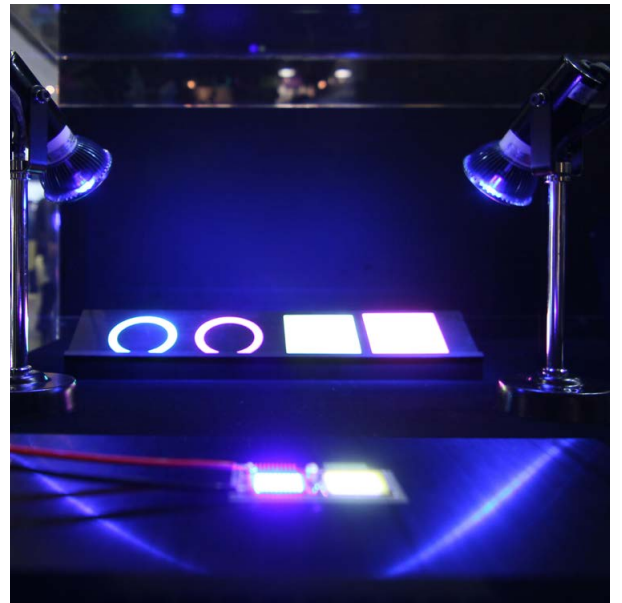

Top-Notch Keynote and Conference

Large audience for the keynote speeches

Almost 1,000 specialists listened to the three keynote lectures held by Christoph Schell, President Lighting Growth Markets at Philips Electronics Singapore who talked about "Lighting at Your Service", Geert van der Meer, CEO Business Unit Light Engines & Controls at OSRAM who presented "Osram's SSL Strategy and Future Perspective", and Junji Kido, distinguished research Professor of the Dept. of Organic Device Engineering of Graduate School of Science and Engineering at Yamagata University who gave a very comprehensive introduction into "OLED Lighting: Current Status and Future Prospects". Each of these three lectures could easily be the subject for a complete article.

Put in a nutshell, Mr. Schell only sees the current situation as the starting point for a completely new and changed business based on the new technologies. He feels we will end up in a situation where lighting is seen as a service using the example of an

airport to explain. To name just a few examples, he said that lighting may help to find the way, to revitalize, enhance the shopping experience and allow interaction in chill-out sites.

In his lecture, Mr. van der Meer explained how the technical progress in LED lighting leads from "good enough" over "cost effective", and ultimately to "new value creation". This last stage is what we can already see when looking at concepts and that should be fully available on the market from 2015 on. He went into more detail saying he expects embedded lighting and controllable light to be the future, based on digital lighting.

In the third keynote lecture, Prof. Kido from the Yamagata University gave the most comprehensive insight in the basics and major challenges of white OLED technology, from its application in white OLED displays, to the OLED devices itself, and to OLED panels; especially panels exceeding current dimensions available on the market. Professor Kido is one of the most important pioneers and researchers in OLED technology and an innovator of the white OLED.

One could ask why white OLEDs should be used for displays and TVs while RGB OLEDs are available on the market. The RGB OLED approach is similar to how plasma TVs work with separate red, green, and blue OLED sub-pixels. This seems to be the best and most efficient technology, because no filters are needed. Unfortunately, it is also the most costly and complicated in manufacturing, and there are some other disadvantages that white OLED based displays have. White OLED displays work rather differently. Red, green, and blue OLED materials are sandwiched together. When powered, these create a white light. This white light passes through color filters, to create the red, green, and blue sub-pixels. Because every pixel is powered separately this still offers an advantage over conventional LCD/LED technology. However, the use of filters always causes losses. Prof. Kido demonstrated that the introduction of a white pixel, an RGBW display, can reduce power consumption by up to 50% compared to a white OLED based RGB display. With this additional white pixel the W-OLED display comes closer to the RGB-OLED approach, but -

Figure 14: One out of three OLED displays use white OLEDs with RGB filters; a similar approach to LED based LCD panels. However, the defining difference is that every single pixel in an OLED display has its own light source. By adding a fourth white pixel, this solution becomes significantly more efficient; namely, up to over 50%. The whiter or brighter the colors are displayed, the higher the efficiency gain

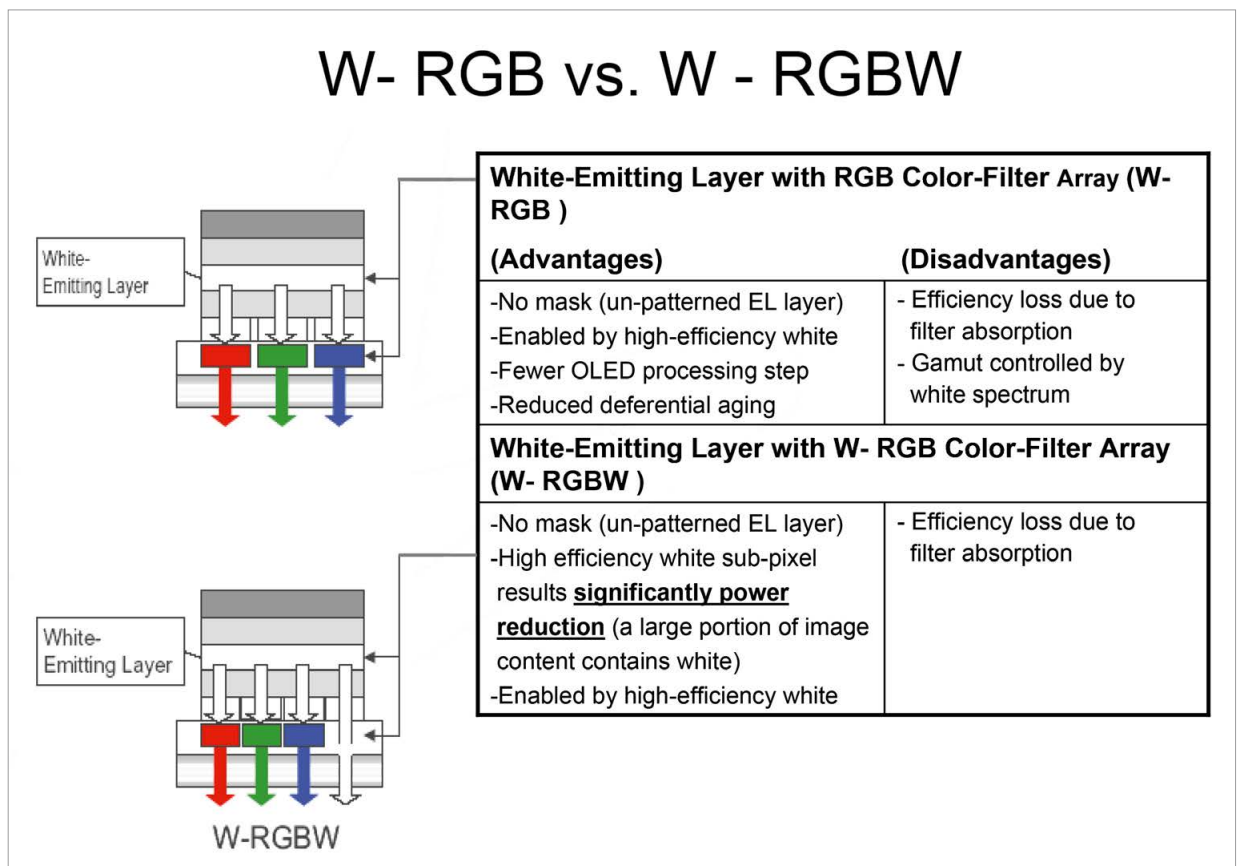

QFN LED FEATURES

EMC lead frame,
Small size, high power,
Max Ta:105°C, Typical R_{th}:10°C/W.



QFN-2835



QFN-3020



QFN-4014



QFN-3030

QFN-2835 series 1W

QFN-4014 series 0.8W

QFN-3020 series 0.5W

QFN-3030 series 1W、2W



深圳市瑞豐光電子股份有限公司
SHENZHEN REFOND OPTOELECTRONICS CO.,LTD.

Stock code: 300241

Tel:(+86)755-29675000

www.refond.com

E-mail:sales@refond.com

Fax:(+86)755-29675111

Microbiog



Figure 15: While the first OLED structure that was proposed was relatively simple; basically consisting of an emissive layer (EML) sandwiched between two electrodes, it has become successively more complex, i.e. the p-i-n OLEDs

even more importantly - the easier manufacturing and hence lower cost as well as the easier scalability may lead to an earlier adoption and acceptance on the market.

Today's white OLEDs often consist of a stack of red, green, and blue OLED materials, the first white OLED had a relatively simple structure, basically a Mg:Ag cathode, electron transport layer, a hole-blocking layer, a hole transporting transmitter, an ITO anode, and a mixture of three fluorescent dopants. However, all white OLED concepts are struggling with very similar issues. One of them is efficiency. Prof Kido explained the reasons in detail in respect to quantum mechanical laws. The currently used systems are based on fluorescence. For such systems only the single state recombination is allowed, which only accounts for 25% of the opportunities, causing 75% of the energy to be wasted as heat. By adding phosphorescent emission, the triple state recombination leads to a theoretical maximum of 100% light emission without any heat. Materials for phosphorescent emission are under development. Unfortunately, high excitation densities and diffusion processes give rise to a high probability of two excitations meeting each other during their lifetimes and may lead to a triplet-triplet annihilation. That occurs when the interaction between these two excitations leads to a non-radiative recombination of at least one of them. This reduces efficiency. A triplet-triplet annihilation may also lead to a singlet state emission.

Another issue discussed in that lecture is the ohmic resistance. Electrode materials and design are another important research topic as well as interfaces, junctions and the overall ohmic resistance in all layers of an OLED. While the original and first OLED designs consists of the design described above with an approximate 120 nm thick organic insulator between the electrodes, later designs like the p-i-n OLED structure approach add additional layers to the stack. In p-i-n OLEDs, an N-doped layer between the

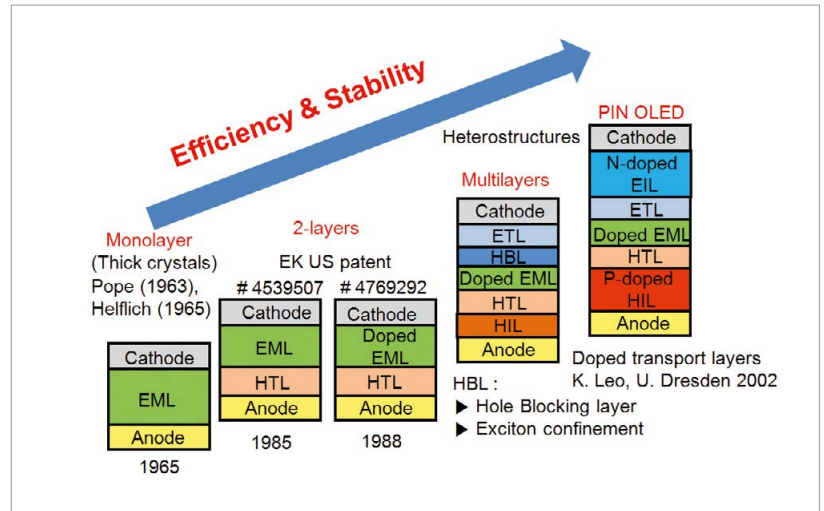
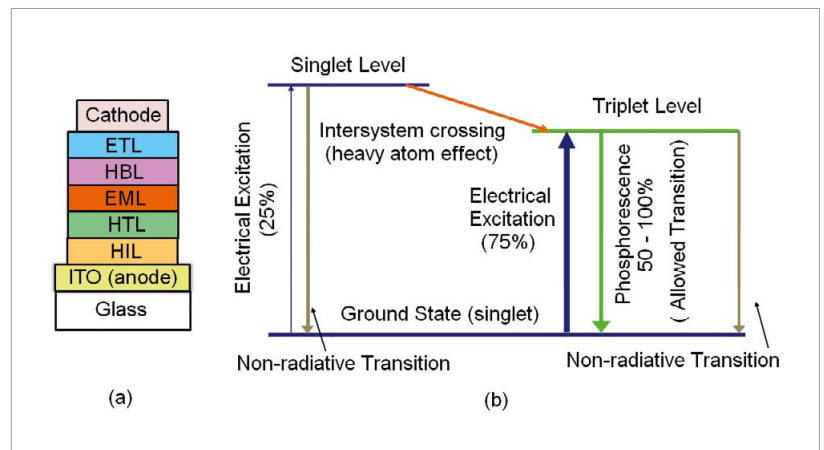

Figure 16: Quantum dynamic laws dictate the necessary addition of phosphorescent light emission to the fluorescent light emission to overcome the efficiency limit of 25%, theoretically achieving up to 100% efficiency: (a) basic structure, (b) functional principle



cathode and the organic insulator and a P-doped layer between the organic insulator and the anode, reduce the thickness of the insulator and thus the ohmic resistance. In a similar way Electron Transporting Layer (ETL) and Electron Injection Layer (EIL) materials are introduced to optimize the device structure.

Before approaching the white OLED panel topics, he also mentioned the different production methods, roll-to-roll printing and solution processed OLEDs with spin coating or spin coating and thermal deposition, topics that were discussed in depth in the lectures of the technical conference. Furthermore, he gave an overview on the efficiency roadmap that forecasts an efficiency for vacuum processed OLEDs exceeding 200 lm/W in mass production by 2020, while the more cost effective printed OLEDs are expected to just exceed 70 lm/W at that time.

Prof. Kido showed that large sized OLED panels, e.g. 30 cm squares, are doable, but also that 14 cm x 14 cm OLED panels still have luminance uniformity issues. He also demonstrated that even when cooled in ice-water, big differences in luminance uniformity may occur. Not only that: He also showed the effect of thermal degradation, herewith blasting the myth of thermally uncritical OLEDs. As a consequence, heat sink or heat transfer optimization as a part of the panel design was found to be important. One solution to keep the design slim is the use of a radiation sheet to dissipate heat by IR radiation. Another important point is the out-coupling of the light. Introducing a suitable out-coupling sheet can improve the luminance from an average of 3,200 cd/m² to over 5,000 cd/m². While less light is trapped within the device, the device becomes much brighter and more efficient and this also helps to lower the temperature.

Figure 17: To overcome efficiency issues when high illuminance is required, a multi-photon emission OLED structure is currently the proposed solution. For example, a three unit MPE can consist of 18 layers

He addressed the development of new manufacturing processes that were discussed in greater detail in session 9 of the technology track of the conference. Here he covered the currently used conventional vacuum process that allows panel dimensions of 370 by 470 mm and takes 4 minutes per unit to the requirements for a low cost approach. Panel size needs to be expanded from 400 by 400 mm to 1,000 by 1,000 mm. The point source deposition, that is absolutely valuable for research, is changed in a linear deposition source and in a next step in an in-line deposition system for the different layers. The final step offers an in-line deposition system for multi-photon OLEDs. Using such a system should allow the production of one square meter white OLED at a cost of approximately 75 Euros.

Finally he gave an overview of the history, current and future developments like transparent and flexible OLEDs, design examples from different exhibitions like LightFair International, Light+Building and Milano Salone, as well as collaboration examples from different companies and the university's related research projects, namely organic photovoltaic (OPV), flexible devices and OTFT –

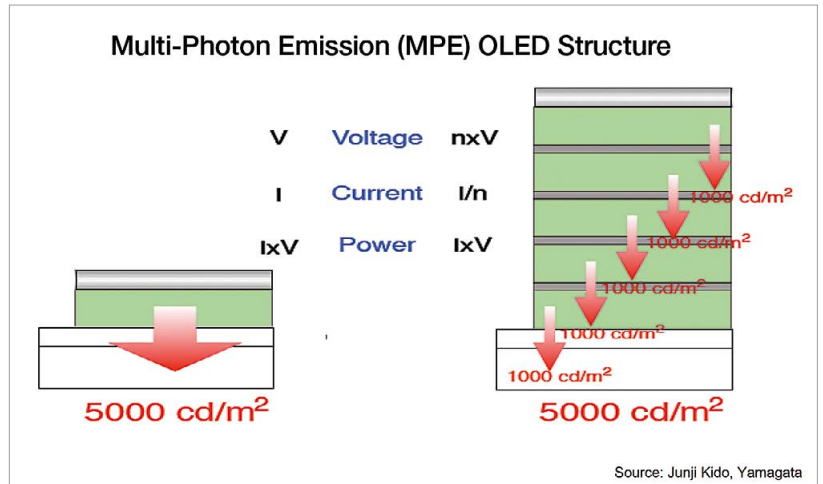

organic thin-film-transistors. He emphasized the trends leaning towards transparent and semi-transparent OLEDs, even thinner OLED panels, larger (transparent) OLEDs or color tunable OLEDs.

Highly specialized, deep insight technology sessions

While all ten technology sessions certainly contained interesting lectures, a comprehensive report on these deep insight lectures would go beyond the constraints of such a report. To give an Idea about the covered topics and the most relevant research activities the next paragraphs will offer an

exemplary overview of three sessions in the technology track; Session 1 – “Lighting Control Technology for Optimum Lighting Environment”, Session 8 – “Cutting Edge Technology of OLED Material”, and Session 9 – “Coating Technology – Key to Improve Productivity” may be the best representative examples to demonstrate the quality of the event and show what are currently essential research topics and results.

Main findings of Session 1's first lecture, held by Prof. Mitsunori Miki, are the remarkable results of research on intelligent lighting systems including color temperature control that showed

Figure 18: One of the major trends and success factors that Prof. Kido addressed in his speech were flexible white OLEDs (credits: Holst Centre), as well as transparent, color tunable and large area OLEDs



the importance and effects of CCT and its control. In office environments, a mix of different illuminance levels and CCTs was found to be best for different tasks. In combination with intelligent controls it was less surprising that such a system also provided significant energy savings compared to conventional existing FL lighting systems and even uncontrolled LED systems. The following two lectures (Nobusato Kobayashi and Kunihiro Sasaki) gave examples for energy saving opportunities using human presence detection and how daylight utilization, lighting and air-conditioning load are linked together and power consumption is affected.

In Session 8 the speakers (Hiroshi Miyazaki, Satoshi Tanaka, and Michael Hofmann) proposed to facilitate a high-efficiency reverse energy shift from triplet to singlet to achieve excitation production efficiency in a luminescent process in great detail, as outlined above. They propose Thermal Activated Delayed Fluorescence (TADF) for this process. The speakers also discussed a new desiccant for packaging of standard OLEDs, thin transparent OLEDs, top-emission

OLEDs and even flexible OLEDs, improving their storage reliability, and the latest progress in PIN-OLED development to improve efficiency and LT50 lifetime to reach 60lm/W and 100,000 hours respectively.

Session 9 also focused on OLED technology. Besides the different technologies, manufacturing issues and differences between low volume lab production and mass production were central topics. The first lecture from Toshihiko Iwasaki showed why, in the laboratory solutions with advanced efficiency, reliability and other performance values are already available, while it still may take some time to solve the same problems in mass production. He addressed the differences caused by spin coating, which is used in laboratories, and die coating, which needs to be applied for mass production. Coating stability, film thickness and film quality are some of these issues. The next two lectures (Christian May and Sandeep Unnikrishnan) concentrated on flexible OLEDs and proposed new or improved materials as well as viable stable R2R processes for mass production of flexible OLEDs.

Conclusions

Now that the radical market expansion driven mainly by demands for energy-saving has stabilized, further market expansion of LED/OLED lighting depends on how it can generate additional value, such as design and comfort. In that sense, Lighting Japan provided inspiration for visualizing further expansion and the deepening of the LED/OLED lighting market. The whole event demonstrated that LEDs have already entered the stage of mass adoption in all lighting fields while OLEDs need to accomplish the transition from high quality but costly lab samples to affordable mass products. The conference was influential with a well-balanced and careful selection of high quality lectures that addressed the right topics. The tripartite exhibition provided an ample impression of the innovative power of the Japanese LED and OLED technology companies, an overview of what can be expected to be available on the consumer market in the near future and how skilful Japan's creative designers are using the new technologies for their luminaire designs. ■



HV9805 HIGH VOLTAGE LED DRIVER

Supertex HV9805 driver IC is specifically targeted at driving LED lamps and LED fixtures with a true DC current. This simple and low cost driver circuit includes a PFC boost stage and a linear regulator: the boost stage for generating a source of high voltage for driving a high voltage LED string and a linear regulator for regulating the LED to a constant value.

Contact Supertex for more info: mktg@supertex.com

Supertex inc.



www.supertex.com



HIGH BRIGHTNESS AND HIGH CRI 3014 LED STRIP

WILLIGHTING 3014 LED STRIP could be 180leds/m or 210leds/m with 24V in White, Nature white and Warm white.

High performance silicon for extremely long life and flexibility. Universally applicable mounting profile for single or double-sided light boxes.

More details, please contact Willighting at
www.willighting.com / sales@willighting.com



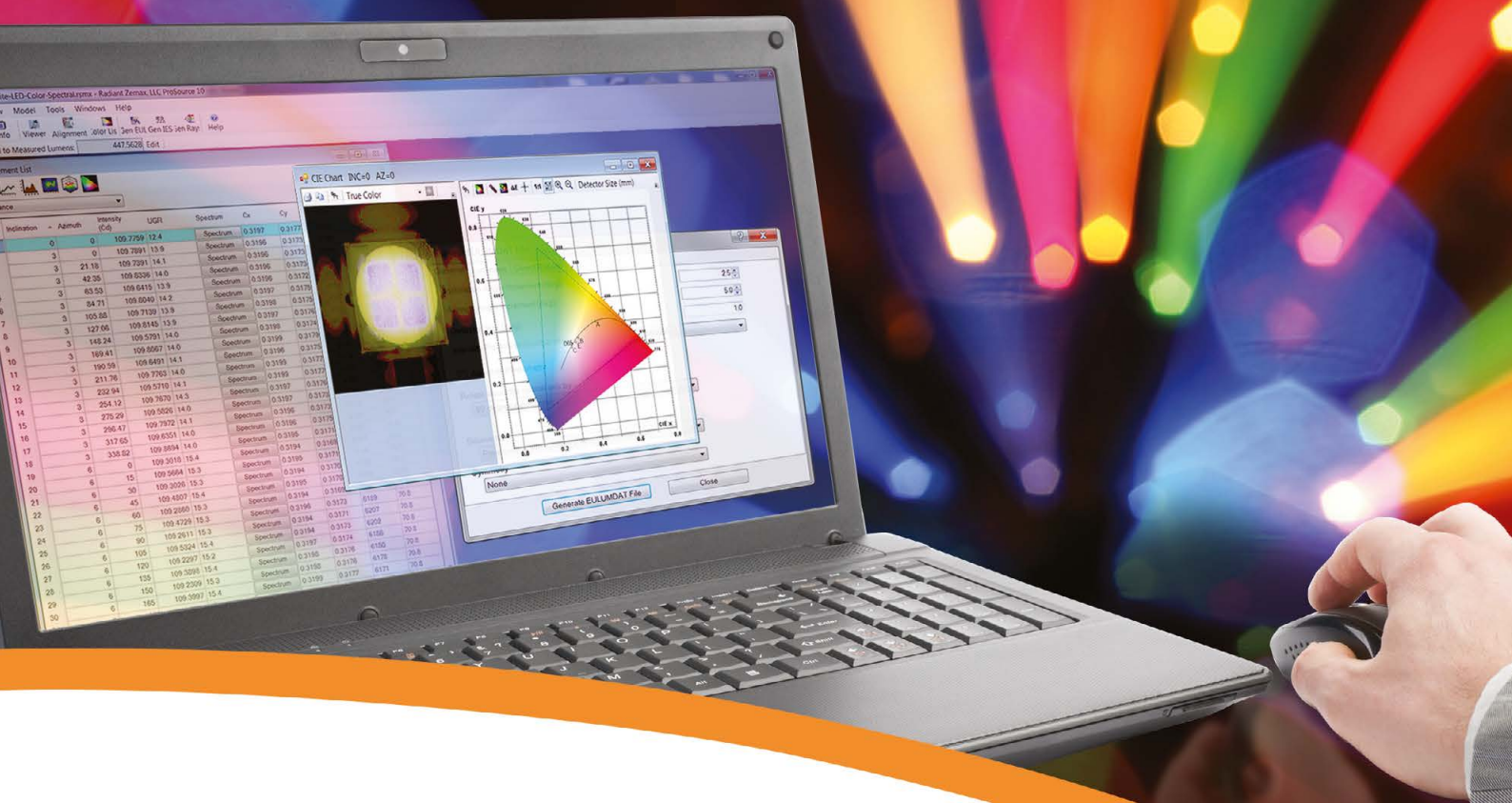

Light Measurement. Simply Radiant.

Compact, Cost-Effective Solutions Simplify Measurement in the Lab or on the Production Line

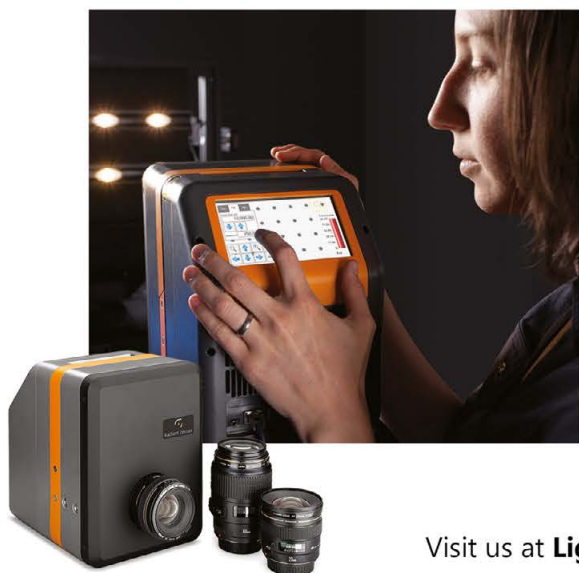

- Radiant Zemax's testing solutions for LEDs, lighting, and luminaires simplify measurement and deliver fast, cost-effective, and comprehensive data to lighting engineers.
- IES, Eulumdat, and Radiant Source Model files are generated quickly and easily.
- Fully integrated hardware and software solutions for testing of intensity, illuminance, luminance, and chromaticity.
- Comprehensive product portfolio features high speed test systems with configurable software and industrial connectivity for high volume throughput, as well as full-featured R&D systems that combine small footprints with rich data output.

Visit us at **Light + Building 2014. Hall 9, Booth F77**
or online at **www.radiantzemax.com**



Radiant Zemax
SEE THE DIFFERENCE

Using LED Technology in Street Lighting

LED technology established itself in the area of street lighting quite a while ago. Today, potentially large amounts of energy savings are facing the challenges of new technologies. Professor Fischer-Hirchert carries out research on the subject of street lighting at the Harz University of Applied Sciences and has also taken part in numerous industrial projects. In this interview, conducted by Siegfried Luger, Professor Fischer-Hirchert talks about the current status of LED technology for street lighting.

LED professional: The Photonic Communications Lab at the University of Applied Sciences in Harz has been working on the general topic of lighting technology for over thirty years with the focus of the past few years on street lighting. What are the basic requirements for modern street lighting?

Prof. Fischer-Hirchert: We have been working on the subject of street lighting on the basis of LED technology since 2008 and have been engaged in developing new, intelligent concepts. Energy consumption of street lighting in Europe is about 35 billion kWh per annum. In Germany alone, street lighting uses about 4 billion kWh per annum, which is equivalent to about 2.5 million tons of CO₂ a year. In addition to that, we have other environmental problems that need to be addressed like light pollution and the disposal of mercury vapor lamps.

LED professional: How much energy would it be possible to save through the changeover to LED technology and optimized complete solutions?

Prof. Fischer-Hirchert: Let's stay with the example of Germany. If we calculate 9,130,000 light points in 13,844 towns with an average burning time of 4,000 hours a year and the cost of electricity at 0.15 Euros, we can expect a savings potential of about 390 million Euros a year.

LED professional: Besides the potential for saving, what other advantages result from the implementation of LED technology in street lighting?

Prof. Fischer-Hirchert: On the one hand, we should emphasize lifetime. This is important because economic considerations have to be made when it comes to maintenance. We are

talking about a life span of 12,000 hours for a HQL lamp compared to 50,000 hours for an LED lamp. This reduces maintenance costs for the communities, which should also be taken into consideration when looking at the whole picture.

Another aspect is the fact that we can now implement light much more intelligently. The light output for LEDs can be changed continuously and quickly, which makes it possible to develop new scenarios for lighting. In addition, the minor amount of insect infestation in the LED lamps plays a significant role.

LED professional: Why is there such a big difference when it comes to insects?

Prof. Fischer-Hirchert: There have been studies that show that PWM controlled light sources have less insect infestation. The color of the light also plays an important role in insect infestation regardless of the type of controls used. There have been differences measured of up to a factor of 10. Our studies showed that the control signals were the most important influencing factor, though.

LED professional: The PWM control system has disadvantages when it comes to possible interference with moving objects. How will you overcome this problem?

Figure 1: From the year 2000 to 2010, the costs for electricity have doubled

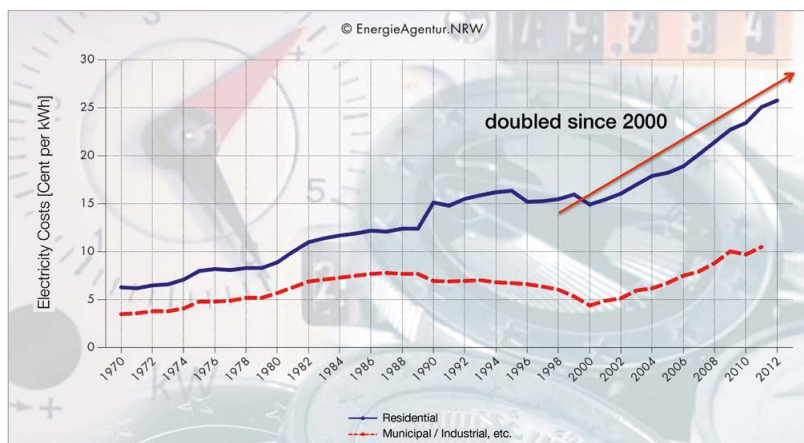

Figures 2 (a & b): New LED street lights (b) consume about 50% less energy than HP-sodium lamps (a) while providing a CRI of 80 and more homogeneous illumination. This leads to better visibility and therefore, a higher safety level (Credits: Osram)



Prof. Fischer-Hirchert: We typically work with a PWM basic frequency of 350 Hz to 700 Hz. This area of frequencies has proven to be favorable. Higher frequencies, for example, would compromise the used power line transmission. When looking at the type of signal, the supply is also important. Pulsating operation is easier to guarantee than a supply running on continuous current. The efficiency of the supply should lie at over 90% because maintenance outlay very much depends on the control and drive electronics.

LED professional: Let's go back to the advantage of dimming through the implementation of LED technology. Dimming means that there is a deviation to the primary lighting engineering design of an installation. From a safety related point of view – is this even allowed?

Prof. Fischer-Hirchert: There are EN and/or DIN standards that need to be followed and different requirements according to the type of street you have. For example, light intensity or the differences between light and dark. On the other hand, a community can decide for itself how it wants to illuminate its streets. A community council order allows the community to determine the times when, for example, there would only be reduced lighting. This type of modified lighting concept can be decided through a council order and is therefore legal even though some of the valid standards are not being observed.

LED professional: Besides the advantages of the LED in regards to light generation, there is the question of optimal light distribution for street traffic. This is especially valid when it comes to the question of reducing light pollution.

Prof. Fischer-Hirchert: There is a very good example for this. There are the so-called mushroom lamps, originally developed by the company Siteco, that are quite wide spread. At the top of the lamp there is a roof and frosted glass surrounding the illuminant, which radiates in all directions. Between the years 1965 and 2005 these lamps were bought and implemented all over Germany. The extreme consumption of about 100 W and the way it self-absorbed made it very ineffective. For example, about half of the light of a lamp on the side of the street shines away from the street. If we could reckon with a stray illumination of about 10%, that would be a savings of 40 W per lamp. If about 30 to 35 percent of all the lamps in side streets and walk ways in Germany would use this type of lamp, we are talking about an enormous potential for saving.

Figure 3: A field study done in December, 2010 demonstrates how moths are attracted to six different light sources

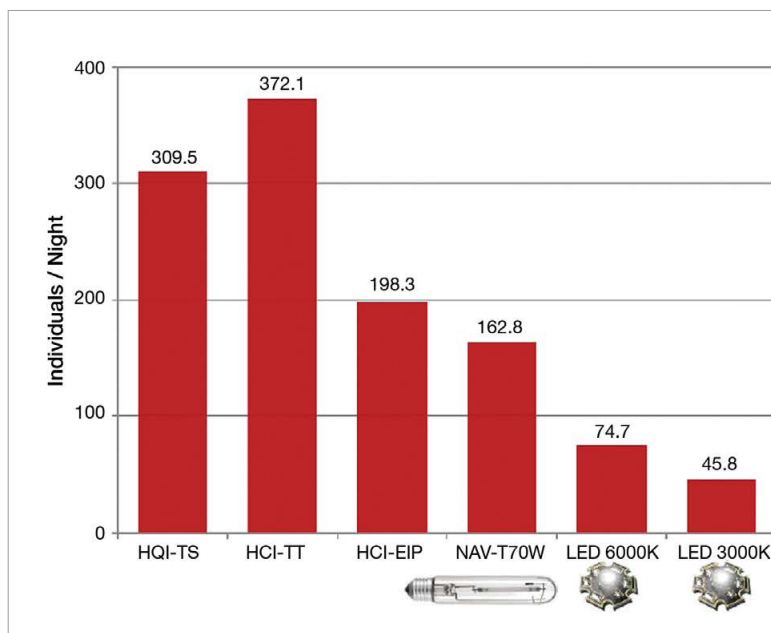

Light sources with a CCT of 3000K or 4000K and a spectrum only providing visible light have proven to be most environmentally friendly solutions



Ulrich H. P. Fischer-Hirchert

Prof. Dr. Engineer Ulrich H. P. Fischer-Hirchert attended the Free University of Berlin where he studied physics with his major in Atom and Solid-State physics. He graduated in 1988. After graduating he worked as a researcher at the Heinrich-Hertz Institute in Berlin in numerous international research projects on the subject of optical telecommunications. From 1995 he led the work group for optical setup and connection technology. Since April 2001 he has headed the professorship for telecommunications at the Harz/Wernigerode College where he concentrates on teaching and researching on the subject of photonics. In 2006 he received his professorship in the area of construction and connection technology at the University of Dresden. He is an active member of the VDE and IEEE and has more than 100 publications and a number of patents in the area of photonics to his name. Within the VDE/ITG he founded and heads a workgroup on the subject of photonic components and microsystems.

- “Mushroom-luminaire”
- Basic technology from the 60ies
- Light sources:
2 x 50 W
2 x 80 W
2 x 125 W
- Used mainly between 1962 and 1985, up to 2005



LED professional: Modern street lighting concepts today are based more and more in combination with alternative energy sources like solar or wind energy. What do you think about this trend?

Prof. Fischer-Hirchert: In one of our sponsored projects we looked intensively at generating solutions for bus stops that are not connected to the public electricity grid. In the end, our concept was based on hydrogen fuel cells that can supply themselves for one year and therefore make the bus stop independent for that period of time. This concept was the best for fulfilling the requirements but economically it wasn't very good because the fuel cells are very expensive. The equipment costs about 10,000 Euros for one bus stop. For solar powered systems you must accurately check which requirements have to be fulfilled. This type of system would be good for remote areas that don't have a direct energy supply.

LED professional: What would you do with a fuel cell after it has run for a year?

Prof. Fischer-Hirchert: The lamp has a 50-liter gas tank that has to be replaced after the 12-month period. The system constantly reports its current status to the central control unit so that maintenance can be coordinated.

LED professional: What is your prognosis for market penetration of LED technology in street lighting?

Prof. Fischer-Hirchert: In my opinion, an important deterrent for the further dissemination of LED technology is the lacking standardization. At the moment, it is primarily the lamp housing that has been standardized but what is needed is the standardization of the LED module. Zhaga is a good starting point for this. In short, interchangeability of the LED module is necessary.

LED professional: Thank you for sharing such interesting information with us?

Prof. Fischer-Hirchert: Thank you! ■



Signcomplex | We bring innovation and give inspiration

Replace your tube with 3P lamp

Are you looking for Water-proof tube?

Dust-proof, Impact-proof, Corrosion-proof ?

Ceiling is too high, your tube is not bright enough ?



Available in 3-8 meters high

Available in 30W / 55W / 70W / 80W

Available in 0.6m / 1.0m / 1.2m / 1.5m



US Pending

Design patent

3

years warranty

IP65

IK08

light+building

Frankfurt, Germany
Booth No. : E11C 2014.3.30-4.4

EXPOLUX

Feira Internacional da
Indústria da Iluminação



San Paulo, Brazil
Booth No. : R37 2014.4.22-26



www.signcomplex.com
marketing@signcomplex.com
phone: +86 755 2760 8650
fax: +86 755 2760 8651

Solder Joint Reliability of LED Packages

LED lighting products are basically characterized by high reliability, long life time and energy efficiency. However, there are some critical steps in the manufacturing process of LED lighting products; one of these is soldering LEDs on a MCPCBs. Saritha Rajamma, Material Scientist at Cree, discloses results of studies about solder joint reliability in respect to thermal stress, package size and design and discusses the failure mechanisms.

The solder joint reliability of high power LED packages mounted on metal core printed circuit boards (MCPCBs) using typical lead free solder (SAC-305) is reviewed. In an LED package, solder joint failures due to thermal shock occur because of fatigue crack initiation and propagation originating from one edge of the solder joint and extending to the opposite edge along the direction of the maximum stress concentration gradient. Cross sectional studies of the solder joints using SEM/EDX analysis confirmed the occurrence of cracks to be more severe towards the LED component side rather than the PCB side due to the formation of brittle intermetallic phases (Ag_3Sn and Cu_6Sn_5). The results presented are for thermal shock cycling in the range -40°C to $+125^\circ\text{C}$, with a dwell time of 15 minutes at each of the temperature extremes, and a transfer time less than 20 seconds. The mean cycles to failure for various XLamp® LED packages performed under these thermal shock test conditions calculated with two-parameter Weibull plots are presented. Projections to other temperature cycling ranges using the Norris-Landzberg relationship are also presented in this article.

Introduction

Commercial applications of high power LEDs have dramatically increased over the last few years. The unique advantages offered by high power LEDs such as high reliability, long life time and energy efficiency are driving the adoption of this technology in markets previously dominated by traditional lighting technologies. For commercial, indoor/outdoor and residential applications, LED-based luminaires need to meet stringent reliability and lumen maintenance requirements. Such requirements warrant a critical understanding of failure mechanisms that drive the reliable performance of packaged LED devices. The reliability of the solder joint between the LED package and printed circuit board (PCB) is very critical in ensuring the overall reliability of LED lighting fixtures. This article describes the reliability assessment of LED to PCB solder joints (Pb-free solder joint) in six high power XLamp® LED packages: XB-D, XP-G, XM-L High Voltage White (HVW), XM-L, MC-E and XR-E mounted on a single layer metal core printed circuit board (MCPCB).

LED Package Structure and Thermal Dissipation

A typical high power LED package consists of a blue LED chip, a ceramic substrate, phosphor (mostly Ce-doped YAG) and a silicone-based encapsulant. The actual construction

and dimensions of the LED package can vary with different manufacturers. An LED converts a portion of the electrical energy supplied to its junction into light depending upon its quantum efficiency. The remainder of the supplied power is converted to heat and needs to be dissipated through the package structure. In an LED device, conduction is the dominant heat transfer mode. The conduction path starts at the junction of the LED chip and extends through the interface to the substrate, through the substrate to the solder joint, from the solder joint to the MCPCB, then through the MCPCB and finally reaching the heat sink (Figure 1). Any disruption to the thermal conduction path can increase the thermal resistance of the package, which could ultimately increase the junction temperature to unacceptably high levels.

Such an increase in junction temperature could cause damage to the LED chip, resulting in a reduction of luminous flux, an increase in the forward voltage of the device and a noticeable shift in the color point of the LED package, all of which limit the usable lifetime of the LED package. Elevated temperatures can also degrade the encapsulant and cause thermal stress to build up within the package due to the thermal coefficient of expansion mismatches between various package components.

Figure 1:
Typical LED package structure

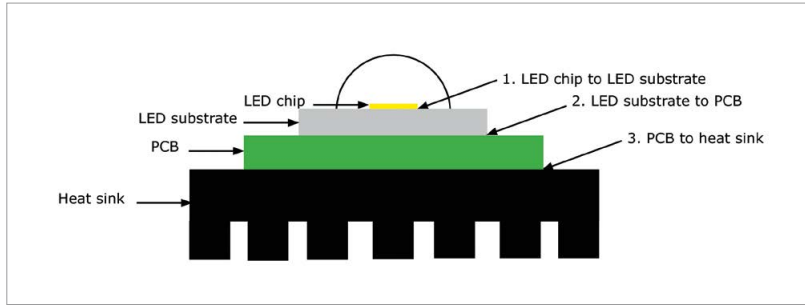

Factors Affecting Solder Joint Reliability

The integrity of the LED substrate to PCB solder joint is one of the key determinants of long-term lumen maintenance and reliability of LED products. A damaged or faulty solder joint can result in an open circuit failure, which in turn can cause the complete electrical failure of the lamp or luminaire. Solder joint failures are a common failure mode observed in electronic packages [1]. The formation of a reliable solder joint depends on several factors such as solder selection, geometry of solder pads, wetting behavior of the solder and attachment interfaces, and intermetallic phase formation [2]. The wetting behavior, interface chemistry and metallurgical microstructure of the solder joint are determined predominantly by the

reflow temperature. In addition, overall solder joint reliability is determined by a combination of the operating environment and system design. The operating environment determines the temperature extremes the product must endure, frequency of on/off power cycling and the possibility of mechanical shocks or vibrational stresses [2].

Thermal Shock Testing

The tested LEDs were selected for the study due to their differences in substrate size. The XB-D LED is 2.45 mm x 2.45 mm, the XP-G LED is 3.45 mm x 3.45 mm, the XM-L and XML-HV LEDs are 5.0 mm x 5.0 mm, and the XR-E LED is 7.0 mm x 9.0 mm. Examples of these package dimensions are shown in figures 2A and 2B (all dimensions in mm).

Test vehicle

The LEDs were mounted onto single-layer metal core printed circuit boards (MCPCBs) for the testing. The MCPCB used in this study is comprised of a solder mask, copper-circuit layer, thin thermally conductive dielectric layer and a metal core base layer made of aluminum. The layers are laminated and bonded together, providing a path for the heat to dissipate from the LED package to the PCB. This study used indium 8.9, Tin (Sn) - silver (Ag) - copper (Cu) (SAC) no clean solder paste. The solder composition is 96.5% Sn, 3.0% Ag and 0.5% Cu and is of Type 3 metal loading having 88.75% metal by weight. The solder paste was printed using Momentum M2M stencil printer LEDs and was mounted on the board using a Juki- FX-3 pick and place machine and reflowed using Heller 1809 MK III convection reflow oven in an air purge environment. JEDEC-J-STD -020C lead-free reflow profile process was used in the current study. Since solder voiding plays a significant role in the reliability of solder joints, the solder attach between the LED package and PCB was evaluated using X-ray imaging. In addition to detecting solder voids, this technique is also useful in locating opens and shorts between cathode/anode contacts and the thermal pad.

Voiding in solder joints beneath surface-mounted electronic packages can contribute to early failures. Less than 30% solder voiding is generally considered to be acceptable, while voiding greater than 50% can be conducive to solder joint failures. As part of this study, LEDs mounted onto boards with solder joint voiding >50% were tested. The stencil dimensions used for mounting the 5.0 mm x 5.0 mm XM-L LED packages to the MCPCBs were undersized resulting in the voiding after reflow. The stencil dimensions used for the 5.0 mm x 5.0 mm XML-HV packages were correctly sized resulting in acceptable (<30%) voiding. The differences in this voiding can be seen in the X-ray images in figures 3A and 3B.

Figure 2:
XLamp® XB-D LED (A) and XM-L LED (B) dimensions

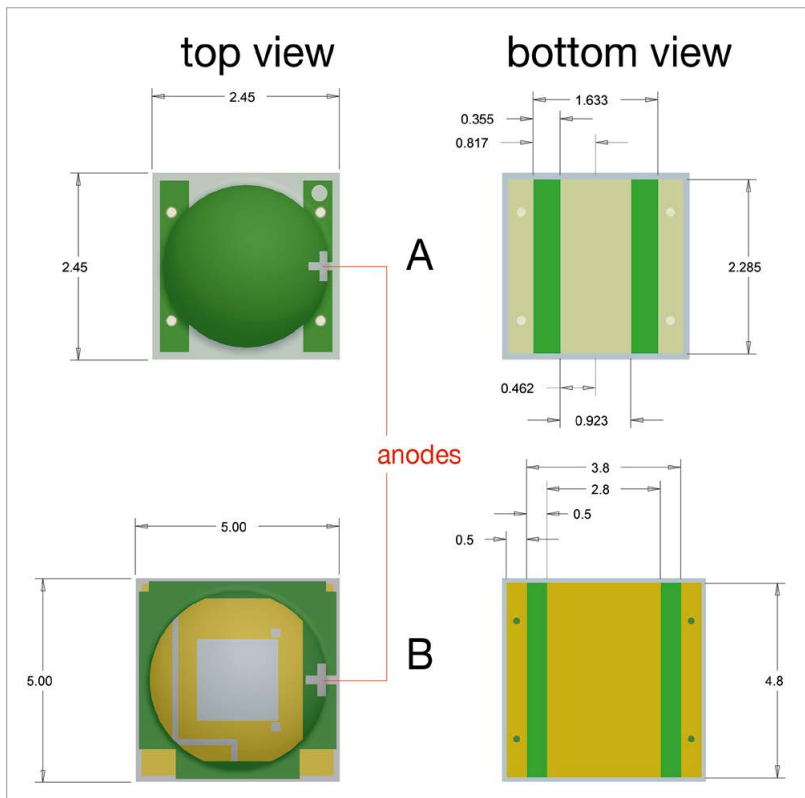
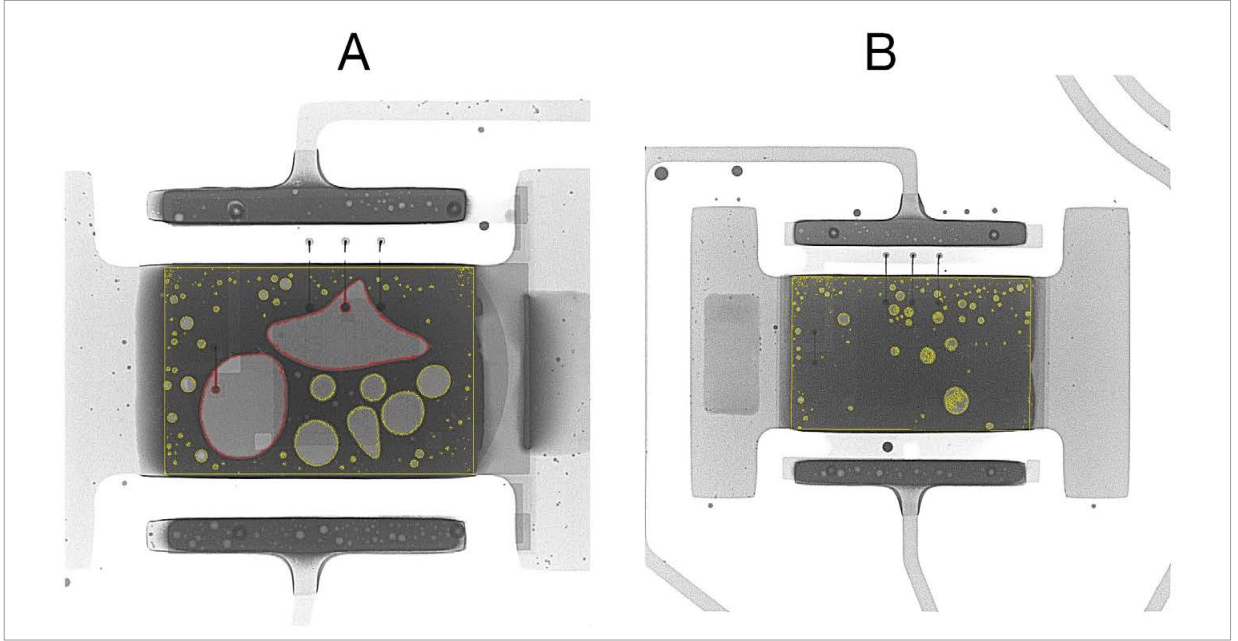

Figure 3:
XM-L LED (A)
 package with
 greater than
 50% voiding, and
XML-HV LED (B)
 package with less
 than 30% voiding
 (X-ray images)



Thermal Shock Temperature-Time Profile

The thermal shock testing was based on MIL-STD-202G-method 107G. In this testing, each MCPCB was subjected to at least 1000 cycles of thermal shock from -40°C to 125°C.

The boards were held at the upper and lower temperatures for 15 minutes. The ramp rate between the temperature extremes was approximately 1.1°C/sec resulting in a transfer time of less than 20 seconds.

Thermal Shock Test Results

The individual LEDs on each board were monitored across several different parameters including optical (luminous flux, chromaticity coordinates, color shift) and electrical (forward voltage, current, leakage current) after every 100 to 200 cycles of thermal shock tests. Since “no light emission” was specified as the failure criterion for the thermal shock tests, the cycle time at which the device failed to light up was identified.

Table 1:
Thermal shock failure data for various LED packages

	XM-L	XPG	XML-HV	XR-E	XB-D
	5 x 5 mm	3.45 x 3.45 mm	5 x 5 mm	7 x 9 mm	2.45 x 2.45 mm
Failure (Cycle)	No. of Failures	No. of Failures	No. of Failures	No. of Failures	No. of Failures
600	1				
700	1				
800	1			1	
1000	1			4	
1100	1				
1200	1		1		
1350	1		1		
1400				3	
1675	1				
1800		1			
1850	1		1		
2000	1	1	3		
2100	1	2			
2200	2	1			
2400	2				
2600		1			1
2700	2	2	2		1
2800		3	3		
3000		1			
Total	17	12	11	8	2

According to the MIL-STD-202G-method 107G, typically passing 200 cycles of thermal shock testing, non-operating life tests is considered to be an acceptable measure of long-term solder joint reliability for LEDs. Of particular interest in these test results is the high number of failures observed with the XM-L LED, which had >50% solder voiding, as compared to the XML-HV LED, which had acceptable voiding.

Interpretation of Thermal Shock Failure Data using Weibull Analysis

The thermal shock data were analyzed using a two-parameter Weibull distribution. The Weibull failure distribution was plotted using the data points from solder joint failures observed during thermal shock testing. The Weibull distribution is given by the equation:

Figure 4:
Weibull probability plot for XML-HV LED subjected to thermal shock tests, -40°C to 125°C up to 2,800 cycles

$$F(t) = 1 - \exp\left[-\left(\frac{t-\gamma}{\eta}\right)^\beta\right] \quad (1)$$

- $t \dots$ Number of cycles to failure
- $F(t) \dots$ percentage failed (the probability of failure) at "t" number of cycles or hours
- $\gamma \dots$ location parameter
- $\beta \dots$ shape parameter (describing shape of the Weibull distribution curve)
- $\eta \dots$ scale parameter or characteristic Weibull life, which represents the 63.2 percentile of the data

Weibull ++@ Version 9 software from Reliasoft was used to plot the charts [3].

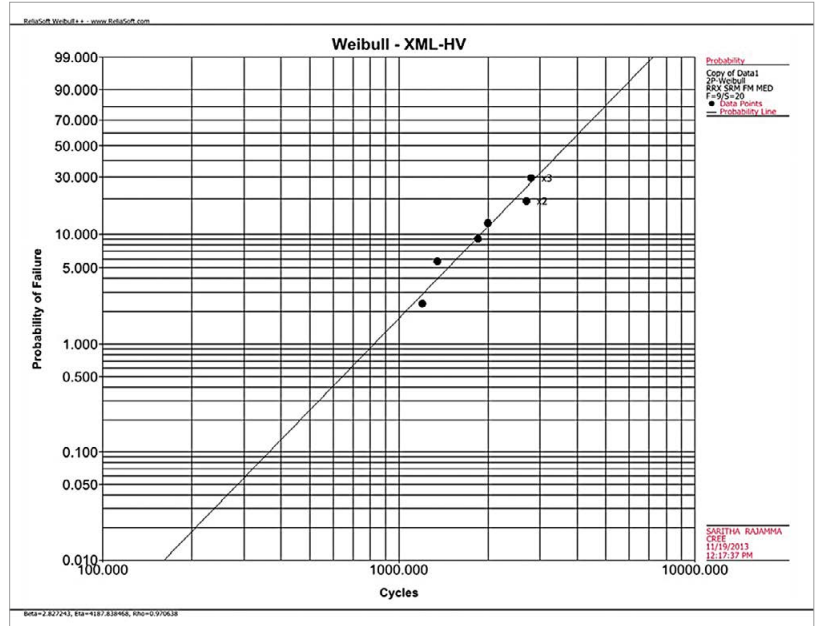
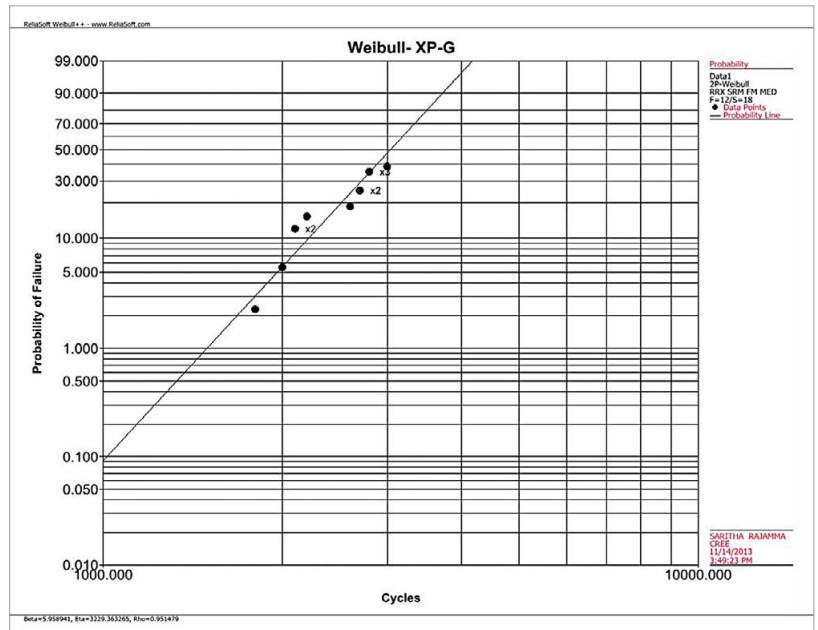

Figure 5:
Weibull probability plot for XP-G LED subjected to thermal shock tests, -40°C to 125°C up to 3,000 cycles

Prediction of Solder Joint Failures Using Norris Landzberg Model

There are several models for predicting the fatigue life of Pb-free solder joints. Each of these models is based on one or more of the fundamental mechanisms that can cause solder joint damage. Such models are plastic strain-based (Coffin-Manson, Solomon, Engelmaier and Miner fatigue models), creep strain-based (Syed model), energy-based (Darveaux fatigue model) or damage accumulation-based (based on Finite Element Analysis). There is, however, no industry-wide standardized model for predicting Pb-free solder joint reliability of LEDs.

In this study, the Norris–Landzberg model was used to predict the fatigue life of the Pb-free solder joints beneath the LED packages. The Norris-Landzberg model is a modified Coffin-Manson model and takes into account the effects of creep, stress relaxation, cyclic frequencies and the temperature dependent properties of the solder. In the Norris-Landzberg model, it is assumed that the devices under test and the product in the field have the same material properties and design parameters (4). Using the model, it is possible to calculate the acceleration factor for the failure mode for two different operating conditions using the formula shown below. Based on this acceleration factor, the number of cycles to failure under various operating conditions can be determined.



$$AF = N_o / N_t \quad (2)$$

$$AF = \left(\frac{\Delta T_t}{\Delta T_o}\right)^B \cdot \left(\frac{t_t}{t_m}\right)^Y \cdot \exp\left\{\left(\frac{E_a}{k} \cdot \left(\frac{1}{T_{max,o}} - \frac{1}{T_{max,t}}\right)\right)\right\} \quad (3)$$

- $AF \dots$ Acceleration Factor
- $N_o \dots$ Number of cycles to fail in application
- $N_t \dots$ Number of cycles to fail during testing
- $\Delta T_t \dots$ Temperature difference during testing
- $\Delta T_o \dots$ Temperature difference in application
- $T_t \dots$ Cycle time duration during testing
- $T_o \dots$ Cycle time duration in application
- $T_{max,o} \dots$ Maximum temperature in application (K)
- $T_{max,t} \dots$ Maximum temperature during testing

Scaling Parameters:

- $B = 2.65$
- $Y = 0.136$
- $E_a/K = 2185$

Table 2:
Test and operation conditions for the XP-G and XML-HV LED packages

Application	Mini. Temp.	Max. Temp.	Temp. cycles/day	Temp. cycle duration
Thermal Shock (test condition)	-40 °C	125 °C	48	30 min.
Thermal Cycling (simulating operating conditions) - 1	0 °C	50 °C	1	1440 min.
Thermal Cycling (simulating operating conditions) - 2	25 °C	85 °C	2	720 min.

From the Weibull plots the mean time-to-failure (MTTF) for the XML-HV LED was 3730 cycles, and for the XP-G LED was 2995 cycles. In order to extrapolate the thermal shock data to customer operating conditions, two sample operating conditions were selected as shown in the table below.

The Norris-Landzberg equation was used to calculate the acceleration

factors for the two operating conditions corresponding to the two examples provided. The resulting acceleration factors are:

XP-G and XML-HV (0 - 50 °C): 49.85
XP-G and XML-HV (25 - 85 °C): 17.49

The number of cycles to failure for LEDs in a luminaire operating under customer operating conditions was calculated

based on equations 2 and 3. The predicted lifetime/cycles to failure for the XP-G and XML-HV LEDs based on thermal shock tests are provided in the table below. For example, for XP-G LED devices under 0°C to 50°C temperature ranges and one cycle per day operating conditions, the estimated lifetime is 149,561 cycles.

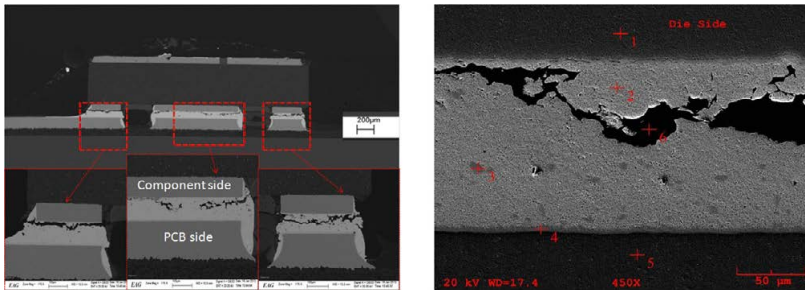
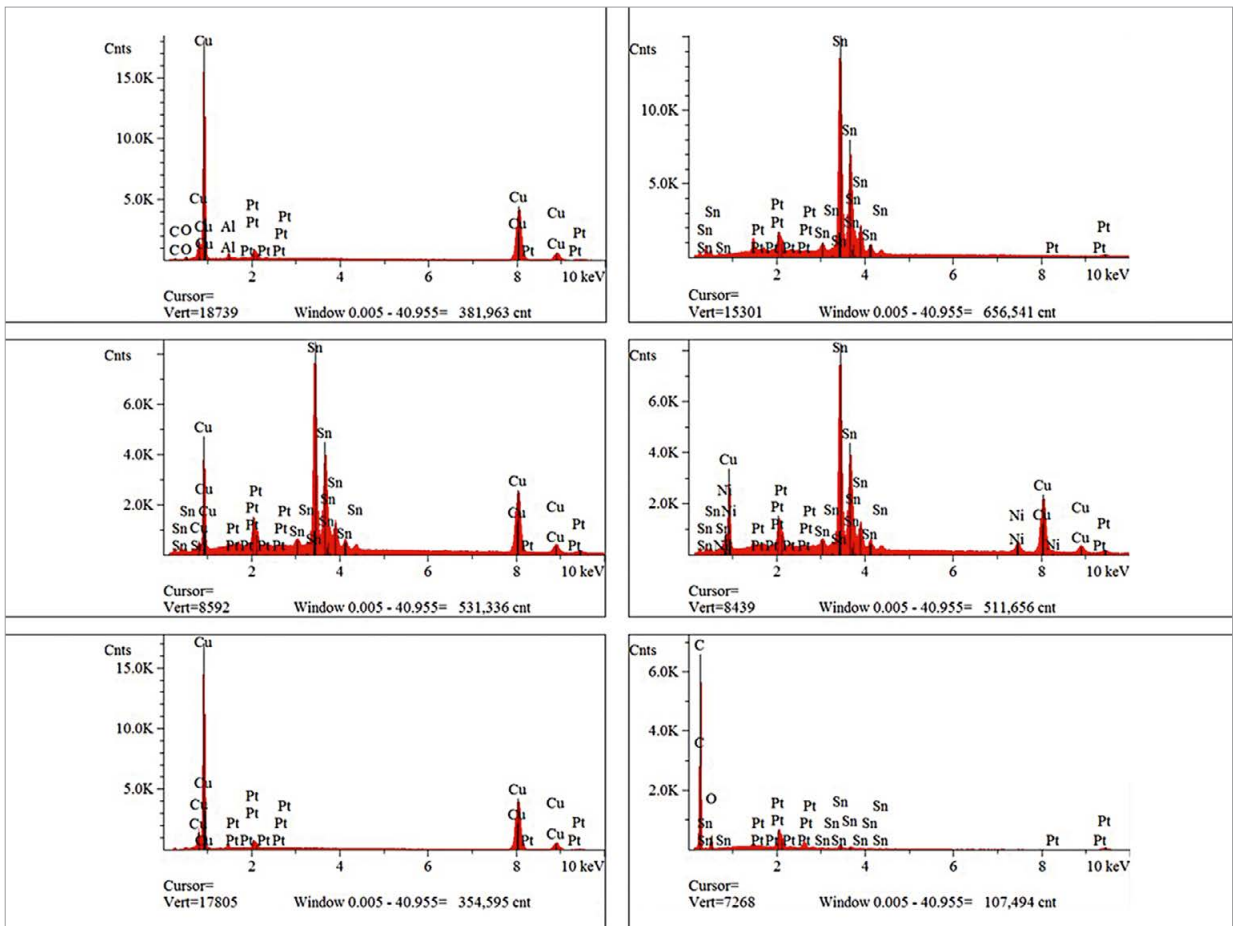

Figure 6: SEM micrograph of XB-D solder joint cross section showing solder cracks after thermal shock tests; EDX analysis was performed at the six locations shown in the right photo

Application	Acceleration Factor	Mean Cycles to Failure
XP-G (0 °C - 50 °C)	49.95	149,561
XP-G (25 °C - 85 °C)	17.49	52,355
XML-HV (0 °C - 50 °C)	49.95	186,327
XML-HV (25 °C - 85 °C)	17.49	65,225

Table 3: Mean cycles to failure data for XP-G and XML-HV LED packages under two different field operation conditions

Figure 7:
XML-HV LED solder joint (top image) with six EDX analysis locations



SEM/EDX Analysis of Thermal Shock Induced Failures

Failure analysis was performed on the solder joint interfaces by investigating the microstructure using scanning electron microscopy (SEM), energy dispersive X-ray (EDX) analysis and optical microscopy to evaluate the integrity of the joints and potential fatigue failure modes. The cross sections of the failed joints indicate that fatigue fracture originates at the edge of the solder (mainly between the tin and silver grain boundaries) and propagate through the length of the solder in the direction of maximum strain. The solder cracks were more severe near the component side compared to the PCB side of the solder joint. EDX analysis of the solder interface showed the presence of silver-tin (Ag₃Sn) and copper-tin (Cu₆Sn₅) intermetallic phases, which are inherently brittle in nature causing solder joint failures.

The graphs below show the EDX probing results of the six different locations with the elements.

Conclusions

SEM analysis of solder joint microstructure identified cracks in the bulk of the solder towards the LED component side of the joint and is attributed to solder joint fatigue. Thermal fatigue failure modes associated with Pb-free solders result from differences in materials' coefficient of thermal expansion (CTE). These CTE mismatches are responsible for the accumulation of stresses and mechanical strains at the material interfaces, which result in fatigue-crack initiation and propagation in solder joints. EDX analysis confirmed the presence of brittle intermetallic phases (Ag₃Sn and Cu₆Sn₅) at the interface, which could weaken the solder joints and ultimately result in catastrophic failures. Based on thermal shock tests, a prediction of the life cycle of solder joints (cycles to failure) could be made by extrapolating the reliability performance from test conditions to samples of field operation conditions using the Norris-Landzberg model. The results show that the mean cycles to failure are LED package size- and application-specific under the given test and operating conditions. ■

References:

- [1] Robert. W Herrick, FA Handbook, Chapter 5, Special Devices, Failure Analysis and Reliability of Opto Electronic Devices, pp 248-250
- [2] SolderJointreliability",www.rohmhaas.com/electronicmaterials/interconnect_technical_site/attachments/ Tech%20comm_%20Jul%2008%20english.pdf
- [3] Weibull ++@ Version 9 software, Reliasoft Corporation, Tucson, AZ, 2013
- [4] Gregory Morose, Sammy Shina, Bob Farrell, Paul Bodmer, Ken Degan, David Pinsky, Richard Anderson, Michael Miller, Louis Feinstein, Deb Fragoza, Eric Ren, Roger Benson and Charlie Bickford, "Long term reliability analysis of lead free and halogen free electronic assemblies" IPC Printed Circuit Expo, APEX& Designer Summit Proceedings

PHOTONICS FESTIVAL in TAIWAN



LED Lighting Taiwan

The 10th Int'l LED Lighting Exposition
www.optotaiwan.com

June 17-19, 2014

TWTC Nangang Exhibition Hall

VIP BUYERS Inviting!
Free Hotel Accommodation

Exhibits

- **LED / OLED Light Source, Package / Module/ Engine**
LED Epi Wafer / Chip
OLED Components,
LED Package, LED Module / Engine,
OLED Module / Engine
- **LED / OLED Lighting Fixture**
Technical Lighting, Decorative Lighting
Accessories and Electronic Components
- **LED Applications**
Backlight, Automobile, Display Board
Traffic Signal, Projector, IrDA, IR / UV Lights, Others
- **LED / OLED Materials**
LED Materials
OLED Materials
- **LED / OLED Equipment**
LED Equipment
OLED Equipment

Organizers



Photonics Industry & Technology Development Association
5F, No.9, Sec.2, Roosevelt Road, Taipei 10093, Taiwan
Tel : +886-2-2351-4026 Fax : +886-2-2396-8513
[Overseas contact]
Sean Su (ext. 883) E-mail : sean.su@mail.pida.org.tw



Taiwan LED Lighting Industry Association



INTERNATIONAL EDITION
OPTOLINK
"Taiwan Photonics Trend and More"
http://www.pida.org.tw/OLIE

Electrical Overstress Protection of LEDs with Proper Circuit Design and Layout Practices

LED lamps and luminaires require protection from the destructive effects of electrical overstress. The authors provide several recommendations to protect against the most common threats. Ron Bonné, Team Leader Technical Solutions, Takaaki Yagi, Leader of Technical Support and Masaki Nishizawa, Technical Support Manager at Philips Lumileds explain which threats caused by electrical over stress (EOS) can be distinguished, how to test, what is critical, and how to prevent damage.

Figure 1:
Common mode
and differential
mode currents

LED circuits operating in the real world can be subjected to various abnormal electrical overstress situations.

Among the most common are electrostatic discharge (ESD), lightning strikes and line transients, EOS during isolation tests of the luminaire, driver failures, and EOS induced by hot-swapping of LED circuits (disconnecting and reconnecting the LED board to the driver while the driver is powered up).

We present background information regarding some of these overstress modes and discuss recommendations to minimize the potentially destructive effects of EOS on LEDs.

Electrical Overstress

EOS can present itself to an LED array in two forms, either as excess voltage or excess current. Because voltage and current are interrelated, it is not always possible to identify whether high voltage or high current caused a failure.

Currents can flow through an LED array in two ways: differential mode or common mode (Figure 1). Differential mode currents can be very destructive. Fortunately, a well designed LED driver from a reputable vendor has built-in controls and protection to eliminate any differential mode fault currents. Common mode currents are more insidious, as they are largely

dependent on the circuit board layout, materials used, line surge protection devices, etc. Most of the recommendations in this article are geared towards minimizing the potential for common mode fault currents.

Isolation Test Requirements

Isolation tests are required for all electrical appliances that are connected to an AC power line, including luminaires. A typical luminaire includes the LEDs, circuit board(s), heat sinks and other thermal management devices, reflectors/lenses/diffusers, and a power supply.

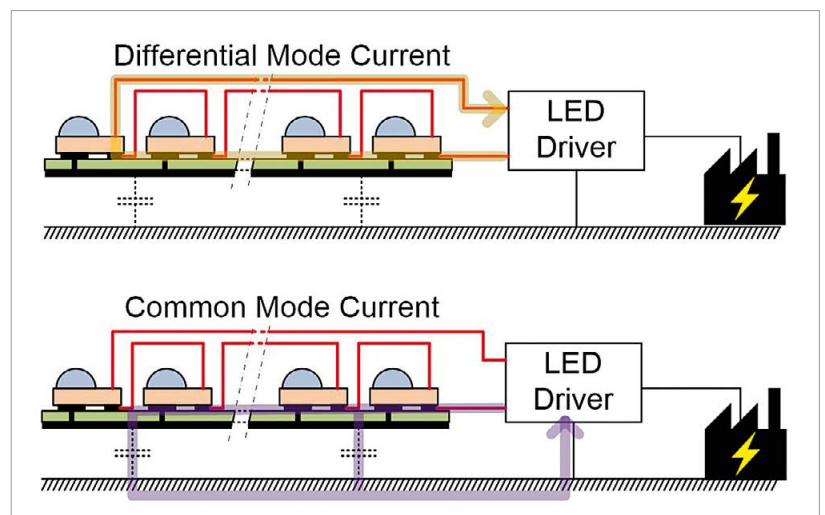

Figure 2:
Isolation test requirements

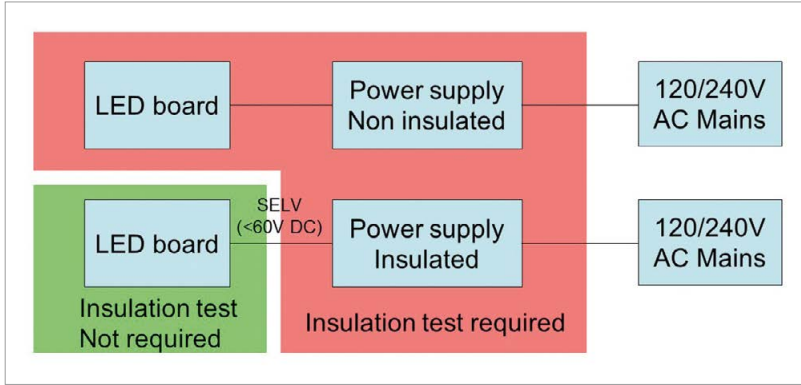

Figure 3:
Typical setup for isolation test of an LED board

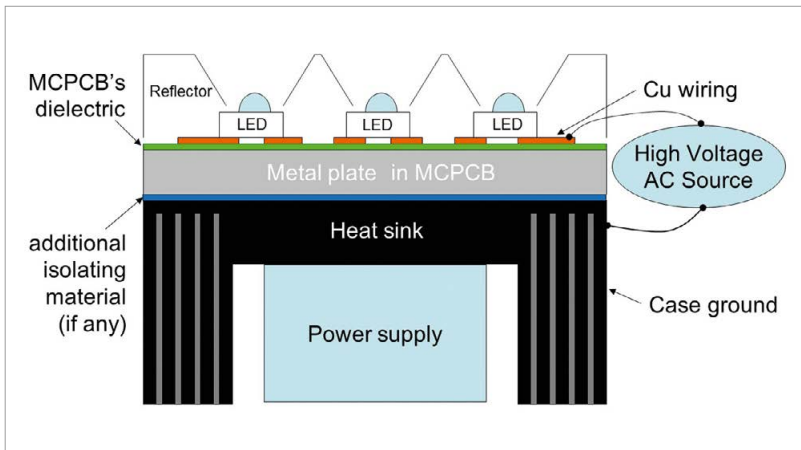
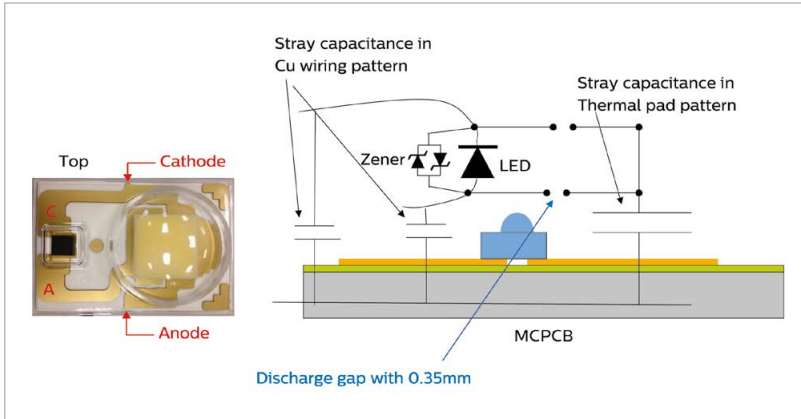

Figure 4:
Equivalent electrical circuit model of a LUXEON Rebel LED on a PCB



Which components are included in the isolation test depends on where the mains separation is implemented in the system. Specifically, the electrical connection from the components being tested to ground is critical. The key components addressed are the power supply and the LED board.

When an isolated power supply is used and the output is SELV (safety extra-low voltage, i.e. < 60V DC), isolation testing of the LED board is not necessary (Figure 2). Depending on local regulations, isolation tests may be carried out as design verification or during the production process.

Some important test specifications that should be considered are:

- IEC/EN 60598, Electric Strength or Insulation Resistance Test; test voltage 1.5 kV AC
- Isolation test between circuitry and ground
- 1000 + 2 x (maximum working voltage) [Vrms] for 1 minute
- SELV (60 to 120 V DC) circuitry needs 500 [Vrms] for 1 minute test
- SELV (< 60 V DC) does not need test
- UL 1598: Electrical Safety for Luminaires

Isolation Test on an LED board

This isolation test checks the safety isolation between the power supply line and the case ground in order to protect users from electric shock. The test method used depends on how the electrical connection between the circuit board, power supply and heat sink is constructed.

Figure 3 shows an example of typical luminaire architecture. The metal in the metal core printed circuit board (MCPCB) is usually electrically connected to the case ground through the heat sink. In this case, a high voltage AC source is applied between the copper traces on the MCPCB and the metal carrier, thereby testing the MCPCB's dielectric layer. When additional isolating materials are used between the MCPCB and heat sink, high voltage is applied to the heat sink and the board traces in order to test the MCPCB's dielectric layer and additional isolating material in series. During the test, all terminals connecting to the board are on one side of the high voltage AC source, while the other side of the AC source is connected to the case ground.

LUXEON Rebel LED Circuit Model on Board

Since the equipment, which is used to perform isolation testing, is very specialized and expensive, it is common to use circuit simulations during the design phase to predict stresses. Figure 4 shows the equivalent electrical circuit of a LUXEON Rebel LED on a MCPCB. This circuit includes the LED, the TVS within the LED package, board trace parasitic capacitance, thermal pad parasitic capacitance and arc gaps ("discharge gaps") that represent the short distance between anode/cathode and the LED's thermal pad.

These five elements can be modeled in SPICE 1. For the trace parasitic capacitance, the standard capacitor equation is applied, using trace area and the thickness and dielectric constant of the MCPCB dielectric:

$$C = \epsilon S/d$$

In this equation, C is the capacitance (in F), ϵ the dielectric constant (in F/m), S the area (in m^2), and d the isolation thickness (in m).

Figure 5 shows an example of an MCPCB for an LED application. The traces shown in red have a total area of 27 mm^2 and $d = 10^{-4}$ m. The dielectric constant is:

$$\epsilon = \epsilon_r \times \epsilon_0$$

$$= 4.9 \times (8.85 \times 10^{-12}) \text{ F/m}$$

In this case the parasitic capacitance of the trace is approximately 12 pF.

The parasitic capacitance of the metal traces connected to the thermal pad of the LED can be estimated in a similar fashion (around 100pF for a LUXEON Rebel thermal pad).

The shortest path distance between anode/cathode and thermal pad on a LUXEON Rebel LES is 0.35 mm. This arc gap is located on the side of the ceramic substrate (Figure 4). In the high voltage test, this minimum gap may show electrical discharge, either through creepage or arcing. Before simulation, the voltage between thermal pad and anode/cathode has to be verified.

If the voltage is less than 35 V, arcing or creepage is not likely and the arc gaps can be omitted from the equivalent electrical circuit model of the LED. Note that during the life of the LED application, dirt, moisture and other material may accumulate on the LED, reducing the dielectric strength of this arc gap; this possibility should be considered in the design phase.

A TVS is incorporated in the LED as a means of ESD protection. This TVS has a zener voltage of approximately 8 V. In the SPICE simulations shown, these TVSs were omitted to better evaluate the potential electrical stress on the LED itself.

Figure 5:
Trace area of copper wiring, which is used to calculate stray capacitance

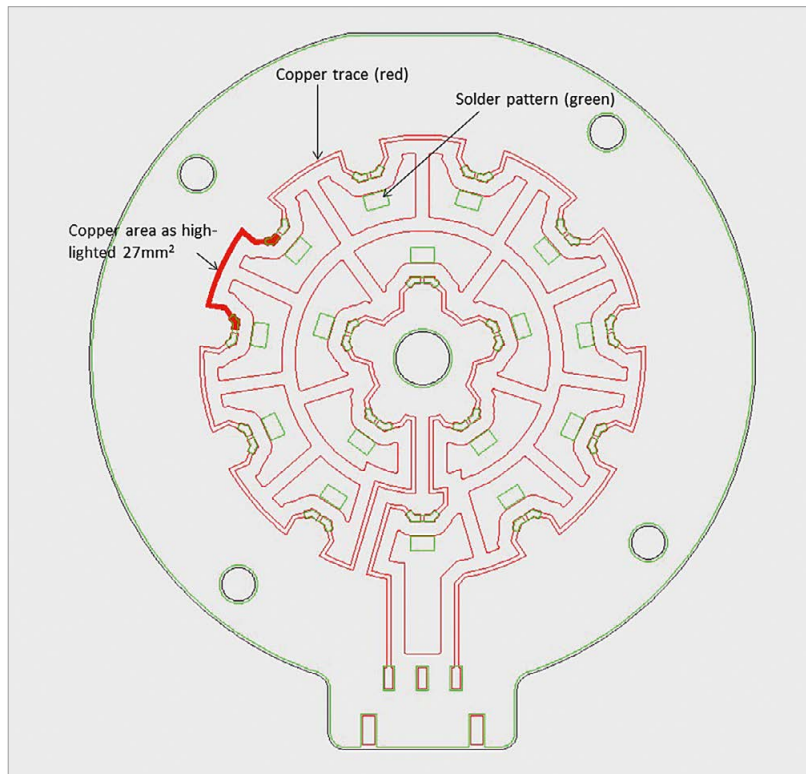
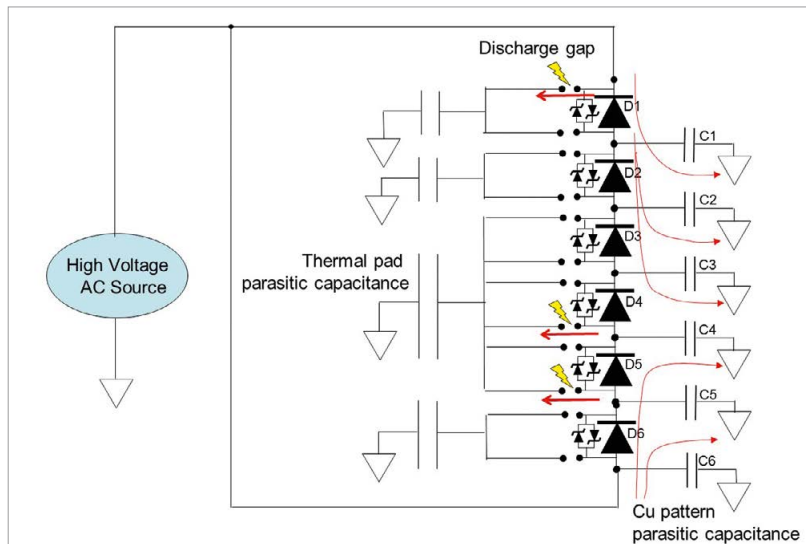

Figure 6:
Full circuit model of isolation test



Electrical Stress SPICE Simulation During Isolation Test

Figure 6 shows the full circuit model of 6 LUXEON Rebel LEDs in series on a board during isolation test. Each LED has its own parasitic capacitance of wiring traces and thermal pad. In this simulation, the high AC voltage is applied between the metal base plate of the MCPCB and the anode/cathode connections.

During the isolation test, AC current flows from the LED array to the case ground through the parasitic capacitances. The leakage current in C1, C2 and C3 is mostly carried by D1, while D2 only carries the leakage current through C2 and C3, and so on. As a result, the LEDs at the end of the string (D1 and D6) carry the highest leakage currents during the test. With a larger number of LEDs in a series string, the current through the end LEDs also increases.

Figure 7 shows the typical LED voltage for two boards with different LED string counts. In both examples, the parasitic capacitance per LED is assumed to be 12 pF and a 50 Hz 1000 Vrms AC source is applied. The LED voltages are the highest on both ends of the LED string. For the string with 6 LEDs in series, the maximum negative voltage is approximately -8 V for LED#1 and LED#6. For the string with 12 LEDs in series, the maximum negative voltage

Leading Through Innovation

SEMILEDs



SemiLEDs' innovative vertically integrated solutions enable cost-effective production of increasingly complex solid state lighting solutions.

Recipient of Technology Pioneer Award!



Vertical LED on Metal Alloy

Patented and proprietary Vertical LED on Metal Alloy technology delivers high performance with increased color stability and lumen maintenance.

SemiLEDs Optoelectronics

Email: sales@semileds.com

Phone: +886-37-586-788

Web: www.semileds.com

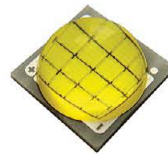
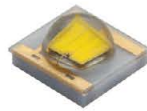

Wherever things get hot

CeramBright Modules

Plug & Light system for interior and exterior lighting. LED cooling at its best.

VISIT US:

light+building · hall 4.0 · booth B91

LIGHTFAIR International · booth #1831



CeramTec GmbH

Phone +49.9231.69387

Fax +49.9231.69-68387

E-Mail lighting_applications@ceramtec.de

www.ceramtec.com/ceramcool

CeramTec
THE CERAMIC EXPERTS

Figure 7: Circuit models for MCPCBs with 6 LEDs (left) and 12 LEDs (right), respectively. Corresponding LED voltage simulations

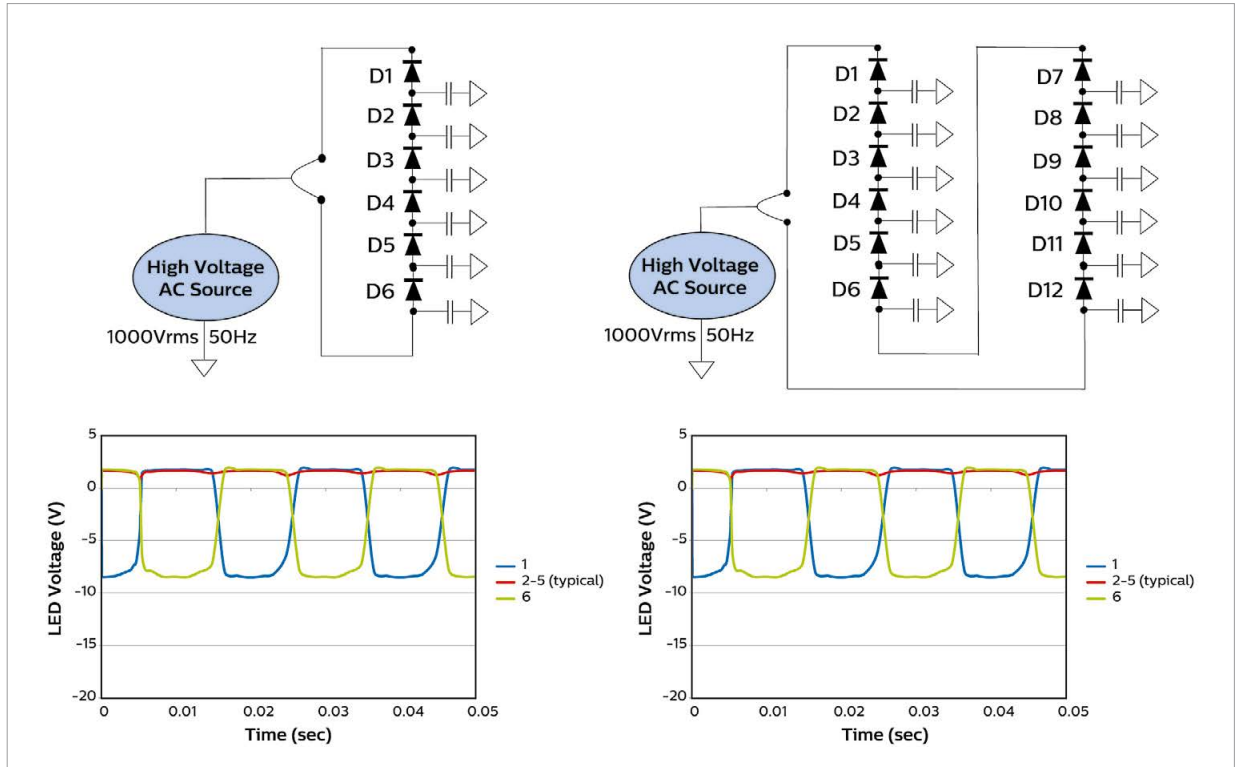

is approximately -20 V at the first and last LED. This example confirms that the maximum LED voltage increases as the LED count in the string increases.

Figure 8 shows the voltage across the arc gap, as simulated in SPICE. In this simulation, only the voltage is calculated; no actual discharge is simulated. Such discharges induce large currents, which will flow through the parasitic capacitances. As a result, discharge will induce excess current or negative voltage stress on the LEDs. This simulation indicates that EOS can be induced in the isolation test, leading to possible LED failure. For this reason, LEDs have to be protected against these voltages.

Protection Circuits

Capacitors can be used as protection devices to reduce harmful voltages across the LEDs and to reduce the likelihood of any discharge during the insulation test. These capacitors connect each electrode of the LED with the anode or cathode of the LED string in order to reduce the maximum voltage during AC operation. These extra capacitors, which should be mounted on the PCB as close as possible to the LEDs, do not affect the board during normal DC operation, but may cause some losses in pulsed (PWM) operation.

The remainder of this section provides guidelines on how to select and dimension the electronic components in this circuit. Note that any dimensions

or ratings that are mentioned in this article for electronic components are for reference only. Any parameters such as impact on driver, energy build-up, rating of components, component lifetime and so on, depend on the actual application conditions. It is recommended that customers do their own due diligence to ensure all relevant performance and safety specifications are met for the application of interest.

A capacitance of 0.1 μ F should be sufficient when using 6 or 12 LEDs in series, assuming the total parasitic capacitance per LED is approximately 12 pF. SPICE simulation results for the 6 and 12 LED board configurations with protection capacitors show that the negative LED voltages on the first and last LED in the string were reduced to less than -100 mV.

It is important to point out that the selection of suitable protection capacitors depends on the trace patterns on the board. In particular, the capacitor value may need to be modified when the circuit board design is changed. In actual testing, the LED negative voltage value will depend on the choice of the circuit board material as well as the wiring patterns.

Figure 8: Discharge gap voltage

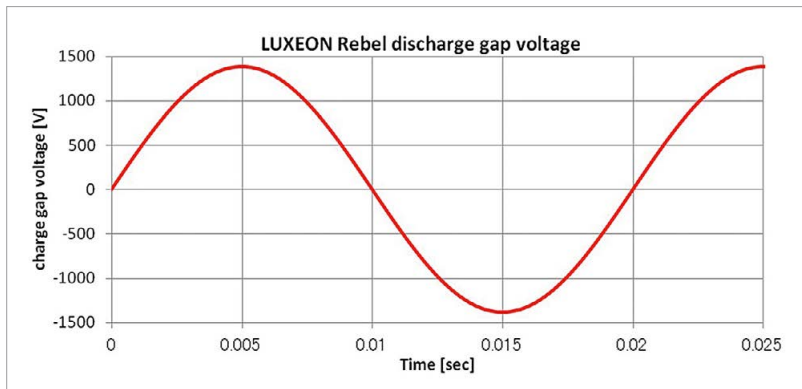
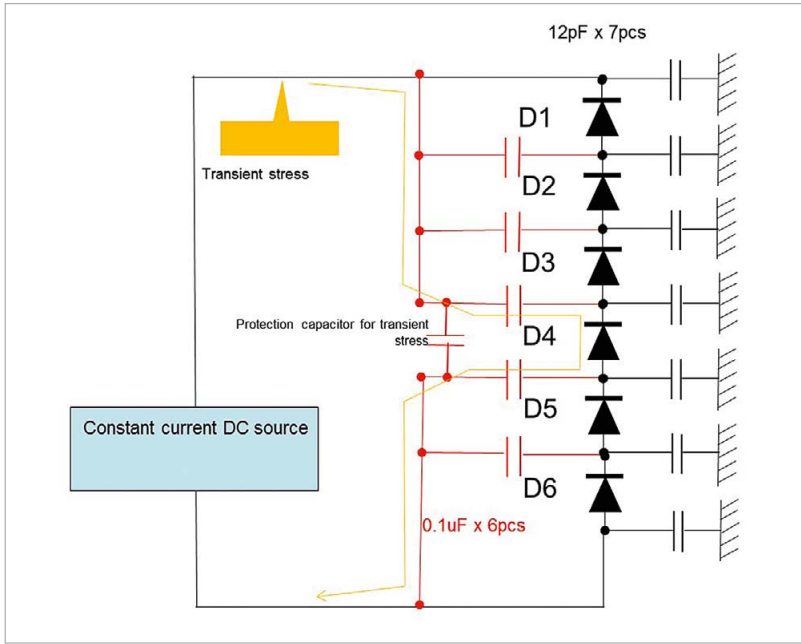

Figure 9:
Protection capacitors during normal operation



In this approach, an additional protection capacitor is recommended. A transient electrical over stress during normal DC operation may attack a single LED because of the protection capacitances. For example, LED D4 in figure 9 will only have stresses when a transient stress is applied. The additional capacitor that is located between cathode line and anode line will reduce the likelihood of electrical stress.

For thermal pad protection, a 0.1 µF capacitor that is connected to the power supply line usually eliminates discharge at the LUXEON Rebel discharge gap as shown in figure 10. With this protection capacitor, the voltage between anode/cathode and thermal pad is less than a couple of volts in the simulation and discharge is not likely to happen.

Figure 10:
Discharge gap voltage with thermal pad protection

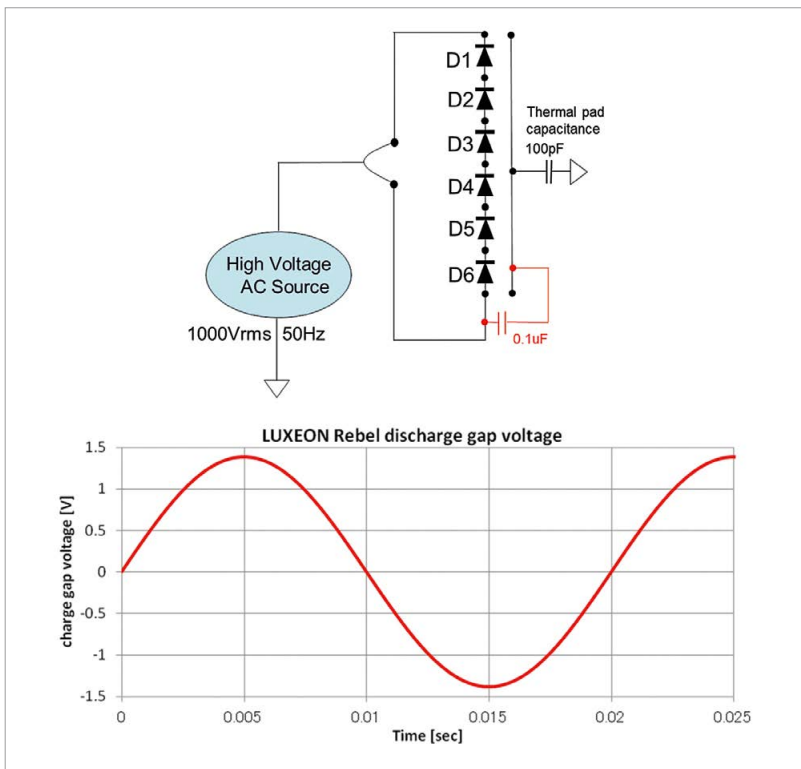

In conclusion, a protection device is helpful to reduce electrical overstress during the isolation test. This protection circuit is recommended to ensure optimum LED reliability in the application.

High Voltage Drivers

Some customers prefer large series strings of LEDs connected to a driver with a high voltage output. Though there is nothing fundamentally wrong with this practice, the above recommendations will not be sufficient. The thermal pads of the LEDs should be electrically separated to prevent a current path through the common thermal pad connection, as shown in figure 11.

Figure 11:
Electrically separate thermal pads

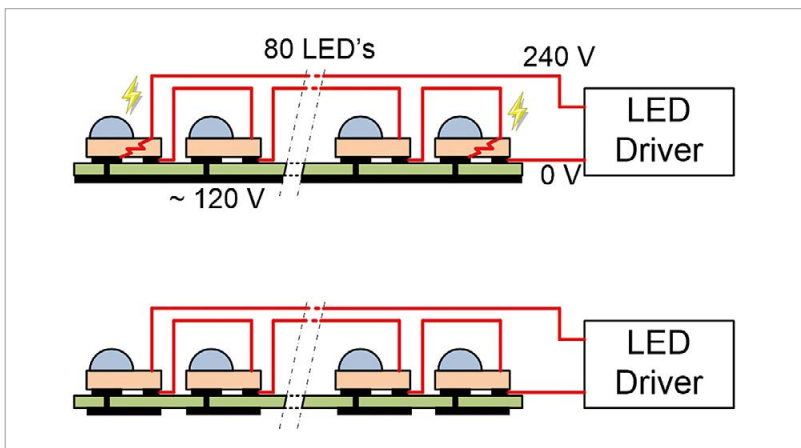

In the top illustration of figure 11, 80 LEDs in series are assumed; in this configuration all LEDs have their thermal pads electrically connected through some common copper plane. As in most cases, this common plane is isolated from ground (i.e. it is electrically floating). With 80 LEDs, the voltage across the string is typically 240 V. Assuming full symmetry, the common thermal pad plane can be expected to float at approximately 120 V. That puts 120 V DC across the arc gap of the first and last LED in the string. It will take very little in terms of moisture or dust for such an arc gap to

Figure 12:
Protection
against line
transients and
lightning strikes

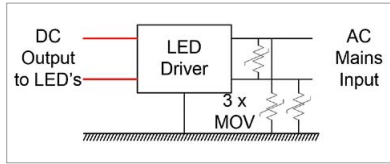

break down, causing temporary current spikes, which might be destructive. Separating the thermal pads electrically allows each thermal pad to “float” to a voltage determined by its stray capacitance. Better yet, the voltage of each thermal pad can be fixed by connecting each thermal pad to the anode or cathode of each LED.

Lightning Strikes and Line Transients

When designing an LED luminaire, careful consideration should also be given to the effects of lightning strikes and line transients. As stated earlier, any differential mode impact of such events is typically prevented by the driver. To prevent high common mode currents, line transient suppression at the AC mains input (Figure 12) has to be considered. A safety approved metal oxide varistor (MOV) is recommended to simplify the safety tests. The dimensioning of the MOVs will be entirely determined by the specifics of the luminaire design and the protection ratings that need to be met.

The likelihood of LED failures due to line transients can be significantly reduced by minimizing the stray capacitance of the thermal pads and by electrically separating those pads.

Recommendations

The likelihood of electrical overstress in an LED application can be reduced by taking the following recommendations into account during the design of the application:

- Minimize the capacitance of circuit board traces to ground by eliminating all unnecessary copper surfaces on the top of a double-sided FR4 board or the circuit layer of a MCPCB/IMS board. The surface area around a thermal pad does not have to be larger than 3 mm outside of the LED package. Increasing the copper area does not significantly improve heat spreading, but does increase parasitic capacitances.
- Keep board traces at least 2 mm away from the board edge in an MCPCB/IMS board and at least 2 mm away from any grounded surface to prevent arcing during isolation tests.
- When using FR4 boards, try to keep the thermal pads of the LEDs electrically floating and separated from each other, or connect them to either the anode or cathode. This will minimize the voltage difference between anode/cathode and the thermal pad, thereby minimizing the possibility of electrical discharge across the LED body.
- Add bypass capacitors and discharge protection capacitors whenever possible.
- Provide an MOV pack at the mains input of the luminaire to prevent transients and lightning strikes from damaging the LED array.
- NEVER hot-swap LED boards. Always switch off the power supply or driver before disconnecting and reconnecting an LED array.
- Use common ESD protection methods during manufacturing and installation of LED luminaires (e.g. ankle-straps, wrist-straps, conductive mats, etc.).
- Isolation tests are not required if an isolated power supply is used and the output is SELV (<60 V DC). This can be accomplished by reducing the number of LEDs in series in a single string.

Conclusions

By following a few guidelines and recommendations regarding LED layout and the use of protection circuits, you can minimize the chance that electrical overstress events will negatively impact your luminaire. SPICE simulation can aid in determining where best to implement bypass capacitors and discharge protection capacitors. Best practices include adherence to the test specifications UL 1598 and IEC/EN 60598. ■

We bring quality to light.



DISCOVERING
LIGHT

More at Light + Building
2014

Putting LEDs in the right light.

SSL solutions from the world leader in LED measurement



LGS 1000
Goniophotometer
with new features

Right from the start, we have been supporting the LED industries with our measurement equipment. You will also benefit from this expertise in the new Solid-State Lighting applications. Our solutions combine highly precise spectroradiometers and photometers with a complete family of goniometers and integrating spheres. Discover light with Instrument Systems.

www.instrumentsystems.com/ssl

Visit us at
LIGHT + BUILDING 2014

Frankfurt, Germany, March 30 - April 04, 2014
Hall 4.1 Booth No. K89/90



Driving Large Scale LED Panels Efficiently

Parallel to the introduction of LEDs for different lighting applications, critical voices argue that due to lowered energy consumption new applications could be introduced and a change in user behavior could lead to excessive use of LED based lighting products during the day, for example, for advertisements. This would cause the predicted hopes for overall energy saving due to LED technology to fail. It seems that this scenario is partially true. Therefore any amount of additional efficiency gain is well worth considering. K.H. Loo, Y.M. Lai, and C.K. Tse from The Hong Kong Polytechnic University examine and propose a new driving approach to achieve energy savings.

Figure 1:
Typical PWM (a)
and MPWM (b)
current waveform

Nowadays, large-scale LED display panels of various shapes and sizes have become a common feature in modern architecture and interior design. LED display panels can be found on outdoor billboards, in commercial buildings and public facilities for advertisements and information display. These panels typically operate for long hours and consume a large amount of electrical power. In some applications, they are even required to remain visible during daylight and thus are designed to deliver light output at high intensity that further increases their power consumption. A reduction of power consumption or an improvement in power efficiency, therefore, becomes a critical design issue of LED display panels for both reduced energy cost and environmental friendliness.

An Alternative LED Driving Approach

Since a large amount of the total power consumption of LED display panels occurs in the LED pixels, driving them efficiently has become a potential area for energy saving. Due to its format compatibility with the input video signal, PWM (pulse-width modulation) method is adopted for driving the individual LED pixels. With the PWM driving method, a constant DC current is applied to a given LED pixel over a duration known as the ON time, or t_{on} , and the current is removed over a duration known as the OFF time, t_{off} . By using the ON and OFF times, the dimming frequency f_{dim} is defined as $1/(t_{on} + t_{off})$, and the dimming duty cycle D as $t_{on}/(t_{on} + t_{off})$. By driving an LED pixel using PWM current, its light intensity can be varied by adjusting the dimming duty cycle as represented by the input video signal. When all LED pixels are driven similarly, textual or graphical information, and even motion pictures, can be formed and displayed by LED display panels.

Despite the advantages of linear dimming and format compatibility with video signal, LEDs illuminated by PWM current generally suffer from degradation in luminous efficacy due to the nonlinearity in the light output characteristic of LEDs, which causes more consumed power to turn into wasteful heat [1]. Not only that this will

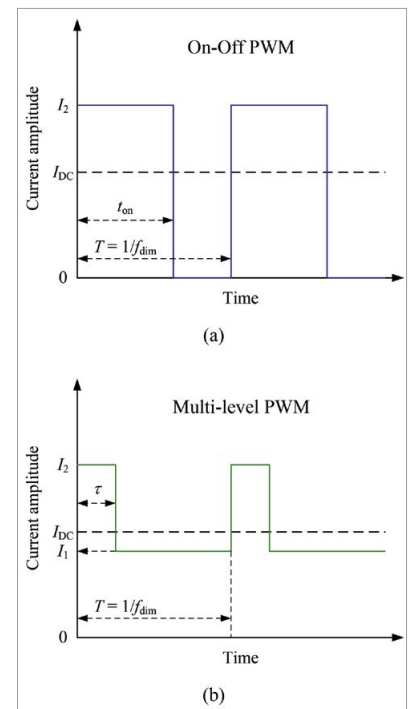

increase the power consumption of LED display panels for attaining a given intensity level, it will also lead to an increase in heat dissipation and a more expensive thermal design. Figure 1(a) shows the typical PWM current waveform having an average value of $I_{ave} = DI_2$; when I_2 is fixed, the average current or the pixel's intensity can be varied by adjusting D . The resulting light output characteristic of a typical LED pixel driven by PWM current resembles the blue dotted line shown in figure 2. For a given average current, the difference between the

Figure 2:
Light output characteristics under three driving methods

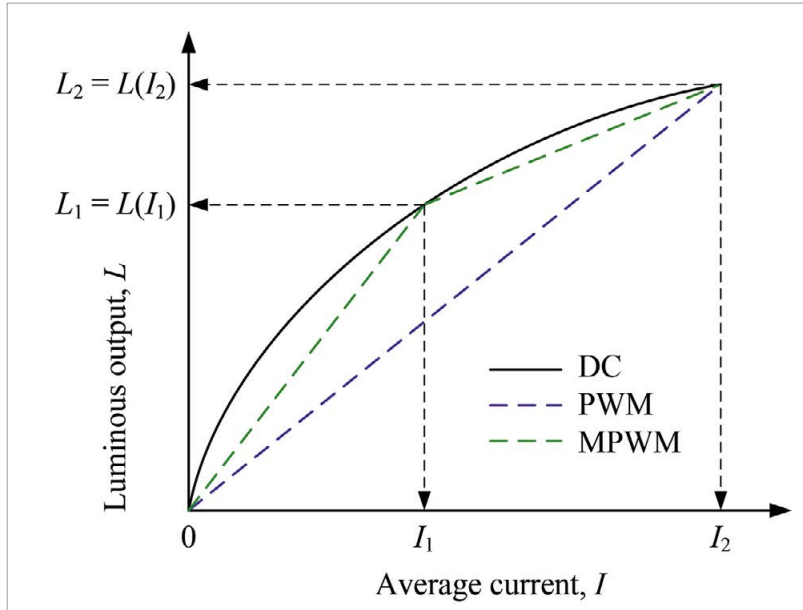

solid black curve and the blue dotted line represents the efficacy loss due to PWM driving.

It has been discovered that by adding current level(s) between I_2 and 0, part of the efficacy loss due to PWM driving can be compensated [2]. An early implementation of this driving approach used one extra current level I_1 between I_2 and 0, forming the bi-level current [2], and it was later generalized to an arbitrary number of current levels forming the multi-level PWM (MPWM) current [3]. Figure 1(b) shows a three-level MPWM current waveform and figure 2 shows its piecewise-linear light output characteristic as the green dotted line. It is clear that MPWM driving gives a higher light output compared to PWM driving with the same average current.

Interestingly, by referring to figure 1(b), the MPWM current can be thought of being the superposition of two PWM currents, one occurring between I_1 and 0, and the other one occurring between I_2 and I_1 , which explains the existence of two piecewise-linear sections in the light output characteristic under MPWM driving.

A Cost-Effective Implementation without System Redesign

The basic PWM-based architecture of a typical FPGA (Field-Programmable Gate Array)-controlled LED display panel system (Figure 3) consists of four main components, namely, the HDMI/DVI video signal decoder, FPGA controller, external RAM, and the LED display module. As the HDMI/DVI video

Figure 3:
Conventional LED display panel system architecture

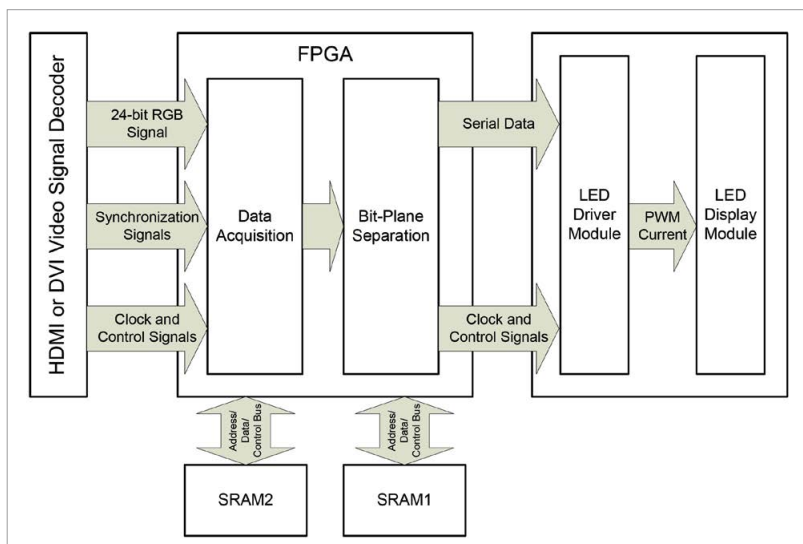

signal cannot be displayed directly on the LED display module due to format incompatibility, it is required that the video signal is first converted into 24-bit RGB signal, where the intensity of each color is coded with 8 bits, thus allowing the display of 256 intensity levels per color. The decoded 24-bit video signal is transmitted in parallel to the FPGA controller where the bit values having the same weight are grouped together. For example, all data bits corresponding to the weight of $2^3 = 8$ are grouped together and transmitted to the LED driver module in one batch, which will illuminate the LED pixels for $8/256$ of the line scan period.

Although, in theory, the number of intermediate current levels between I_2 and 0 can be arbitrarily many, the choice of one additional current level, thus forming a three-level MPWM driving scheme, is a reasonable one given the proportional increase in system complexity and cost despite the diminishing percentage gain in luminous efficacy with the increasing number of intermediate current levels. It is also necessary to maintain the light output characteristic as linear as possible.

To implement a three-level MPWM driving scheme on LED display panels, two LED driver modules can be connected in parallel to provide two constant-current drivers. It can be easily shown that the percentage gain in luminous efficacy is the maximum when each LED driver module delivers $I_1 = 0.5 \cdot I_2$ [5], and the corresponding three current levels are 0, I_1 , and $2 \cdot I_1$. Although the number of LED driver modules used is doubled in this case compared to the conventional PWM-based system, the additional hardware cost incurred is not doubled given that IC manufacturers can redesign the existing LED driver module ICs to house multiple driver modules within one IC package.

With the use of two LED driver modules, two separate bit-streams are needed to activate them. In the modified system architecture (Figure 4), each of the two bit-streams is derived from the original input video signal that

Figure 4:
Modified LED display panel system architecture for compatibility with MPWM driving

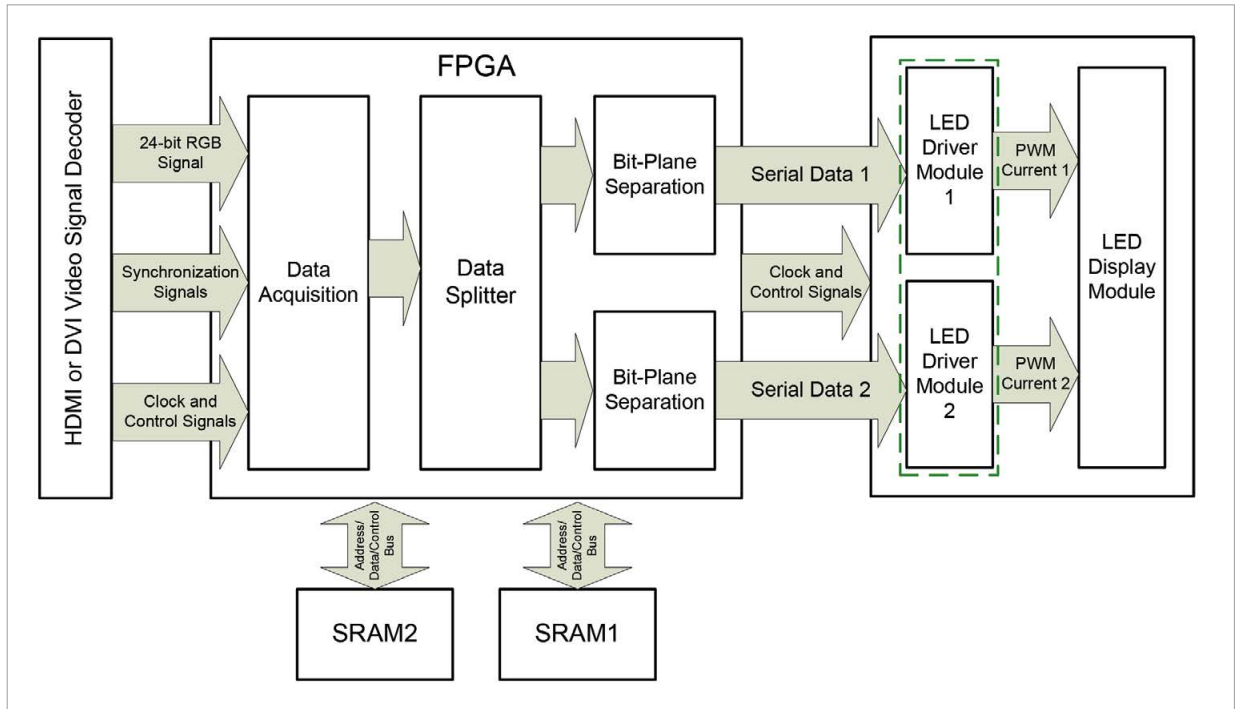

is turned into two sub-video signals by the data splitter unit in the FPGA. An example of data splitting is given here to illustrate the data conversion process. Suppose that the original input video signal is [1100 0101] in binary form, or [197] in decimal form, the equivalent duty cycle represented by this signal is $197/255$. In a PWM-based system, the desired average current is given by $I_{ave} = (197/255)I_2$. Since $I_2 = 2I_1$, I_{ave} can be rewritten as $I_{ave} = (394/255)I_1$, or

$(255/255)I_1 + (139/255)I_1$. Therefore, in a MPWM-based system, the same desired average current can be delivered by two LED driver modules, one delivering I_1 for the complete line scan period, and the other one delivering I_1 for 139/255 of the line scan period. For the first LED driver module, the FPGA will output an 8-bit data stream of [1111 1111] (= 255), and for the second LED driver module, the FPGA will output [1000 1011] (= 139). These simple arithmetic

calculations can be implemented easily on the FPGA controller with no additional cost.

In a prototype of LED display panel (Figure 5) assembled with 2 x 3 display modules, the upper row (containing three display modules showing blue, green, and red color, respectively) is driven by PWM current, whereas the lower row is driven by MPWM current having the same average value as the PWM current. The differences between the two driving approaches in the generated light intensities for all three colors are clearly visible from the figure. To give a more quantitative comparison between them, the generated light intensities by the two driving approaches were measured for each color over the full range of average current (from 0 to 255) and the results are plotted (Figure 6). For all three colors, MPWM driving consistently produces higher light intensities, as expected from the previous analysis on LED's nonlinear light output characteristic. The piecewise-linear sections in the light output characteristic resulting from MPWM driving are also evident from the figure. On average, the percentage gain in luminous efficacy over PWM driving is 12% for blue, 14% for green, and 10% for red, respectively.

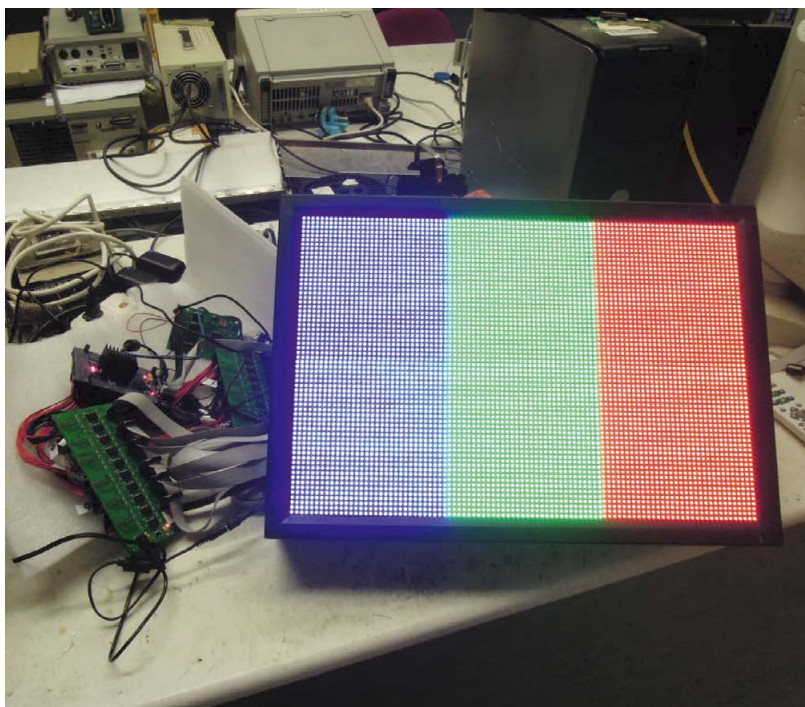

Figure 5: Prototype of an LED display panel with 2 x 3 display modules

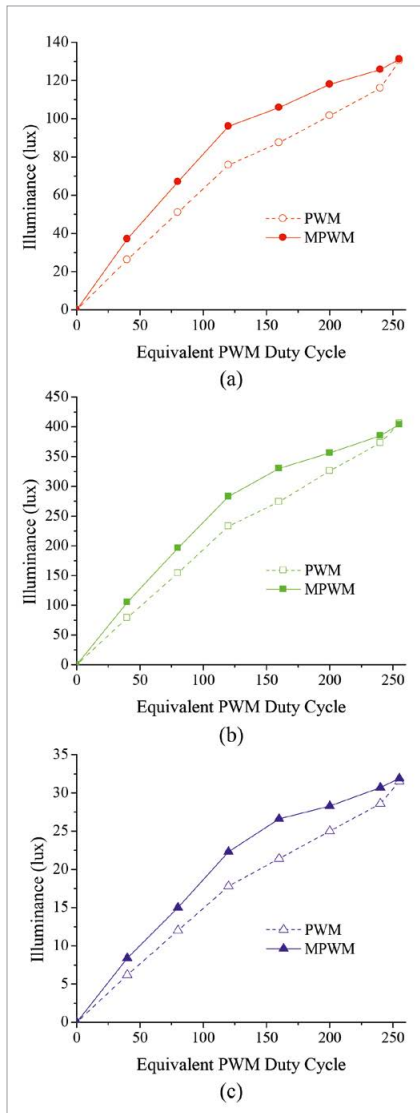

Figure 6: Measured light intensities generated by PWM and MPWM driving approaches for all three colors (RGB)

References:

- [1] K.H. Loo, W.K. Lun, S.C. Tan, Y.M. Lai, C.K. Tse, "On Driving Techniques for LEDs: Toward a Generalized Methodology," IEEE Transactions on Power Electronics, Vol. 24, No. 12, pp. 2967–2976, 2009
- [2] W.K. Lun, K.H. Loo, S.C. Tan, Y.M. Lai, C.K. Tse, "Bilevel Current Driving Technique for LEDs," IEEE Transactions on Power Electronics, Vol. 24, No. 12, pp. 2920–2932, 2009
- [3] S.C. Tan, "General n-Level Driving Approach for Improving Electrical-to-Optical Energy Conversion Efficiency of Fast-Response Saturable Lighting Devices," IEEE Transactions on Industrial Electronics, Vol. 57, No. 4, pp. 1342–1353, 2010
- [4] Data Sheet, MBI5020: 16-bit Constant Current LED Sink Driver, Macroblock Inc., 2003
- [5] X. Lv, K.H. Loo, Y.M. Lai, C.K. Tse, "Energy-Saving Driver Design for Full-Color Large-Area LED Display Panel Systems," IEEE Transactions on Industrial Electronics (in press) (Document DOI 10.1109/TIE.2013.2288209)

Remarks:

1. The work had won the Gold Medal in the 41st International Exhibition of Inventions 2013, Geneva, Switzerland, 10–14 April 2013.
2. Full technical details of the technology described in this article can be obtained from reference [5], a journal paper published by the same authors.

Conclusions

With the introduction of LEDs and the related new opportunities, display panels of various shapes and sizes have become more popular. Early studies predicted that such applications and the usage under daylight conditions might become common practice. The high necessary light output leads to corresponding high energy consumption. An intelligent driver design can increase system efficiency notably. It could be demonstrated that the proposed solution leads to an average energy saving of 12% in RGB billboard systems without compromising functionality, thus making such applications more environmentally friendly. ■



BEYOND SAFETY

UL SERVICES AND EXPERTISE BRING NEW OPPORTUNITIES TO LIGHT

- Obtain Safety, Energy Efficiency, Performance Certifications and more
- Access Global Markets
- Leverage Industry Expertise and Standards Development
- Get a Type C Goniophotometer for Your Lab

DISCOVER MORE AT
UL.COM/LIGHTING
 LIGHT+BUILDING,
BOOTH #4.1 – A15

LIGHTFAIR
 INTERNATIONAL
UL BOOTH #5446



Sensor-Driven Designs to Allow More LED Bins and Lower Costs

Cost reduction is currently one of the most important issues for LED lighting manufacturers. Although it might sound contradictory, sometimes the introduction of an additional component can help reduce costs. Sajol Ghoshal, Vice President of Strategy Development of Optical Sensors & Lighting Division at **ams**, explains how sensors can reduce costs while increasing light quality in some types of LED luminaires.

As with most electronic components, LEDs emerge from the manufacturing process with natural performance variations. In the case of LEDs, these differences in luminosity and color result in a large number of individual “bins” from each production run. Lighting manufacturers that understand the importance of color and output consistency from luminaire to luminaire have employed a variety of mechanisms to achieve a quality result, with each creating its own set of cost-performance tradeoffs. With the wider availability of higher-accuracy color sensors, a new avenue has opened up that will allow the use of lower cost binning approaches with increased quality of light.

Binning and Color Accuracy

In conjunction with the commercialization of white LEDs in the early part of the last decade, LED manufacturers quickly recognized the need to create a comprehensive binning strategy that would enable luminaire manufacturers to select LEDs at fairly precise correlated color temperatures (CCTs) to meet the needs of lighting users across the breadth of applications LED technology would find itself in.

The human eye is very sensitive to even very small differences in color, with as little as a 2-3 standard deviation color match (SDCM) producing a visible color difference to some observers.

A 2 SDCM variance is essentially the same as 2 MacAdam ellipses, or ± 0.001 $u'v'$ on the CIE color diagram.

As a result, the industry moved quickly to implement binning standards that could account for both the realities of LED and semiconductor manufacturing, as well as the human side of color perception. The outcome of these efforts were the 2008 ANSI C78.377A standard LED bins, which roughly represent 7-step MacAdam ellipses with the foci of each at common CCTs on the well-recognized black body curve.

Manufacturers subsequently defined their own specific sub-bins that most often divide the ANSI bins into quartiles, and in some cases, dividing each of the quartiles into another 4 bins. Those 16 sub-bins inside each ANSI bin will typically deliver precision of one to two

Figure 1:
CIE Black body curve and ANSI LED color bins

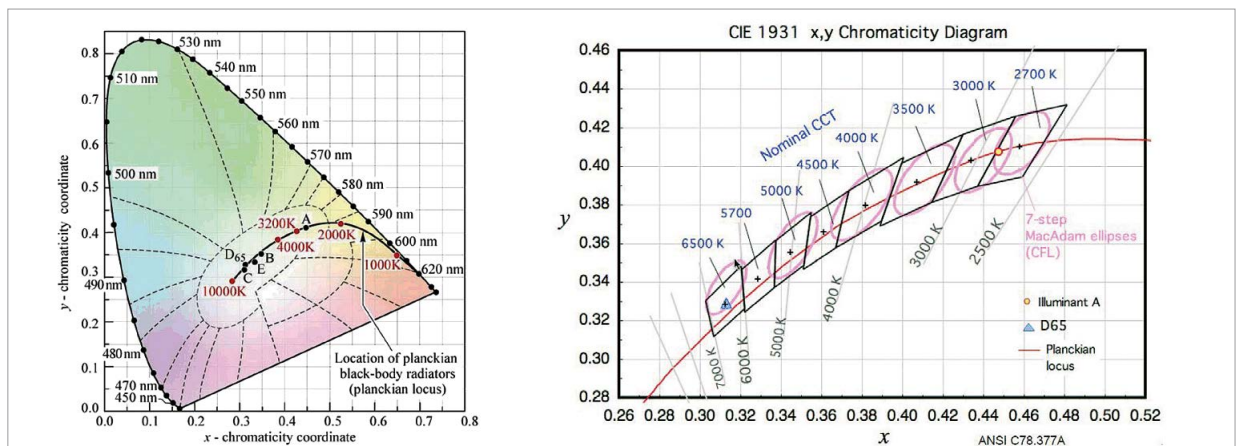



LIGHTFAIR

INTERNATIONAL

The future. Illuminated.

2014

THE NEW LANGUAGE OF LIGHT

LAS VEGAS, NV USA
Las Vegas Convention Center

TRADE SHOW & CONFERENCE
6.1.14 - 6.5.14

LIGHTFAIR.COM

IALD



PHOTO CREDITS
TOKYO SKYTREE, TOKYO, JAPAN |
LIGHTING DESIGN BY SIRIUS LIGHTING
OFFICE INC. & NIKKEN SEKKEI LTD |
PHOTOGRAPHY, ©TOSHIO KANEKO

Figure 2:
Hypothetical LED
production run
distribution

MacAdam ellipses; effectively a single, consistent color to the eyes of most observers.

Binning Versus Cost

When an LED manufacturing run works perfectly, the color variance of the resulting devices will be concentrated around the target point (most often the intersection of the chosen CCT and the BBC), with a scatter plot of lower concentration emanating outward, often in a southwest-to-northeast type of bias (Figure 2). While that typical distribution is the outcome when the process is perfect, there are enough variables involved that off-center concentrations can't be ruled out. While the standard binning makes those results transparent to the component purchasers, it does suggest that the availability of a single bin could be subject to mild, or even wild, variation. Manufacturers can mitigate the supply variation with the use of a network of stocking distributors, but ultimately, that is simply buffering the supply, rather than reshaping the scatter plot.

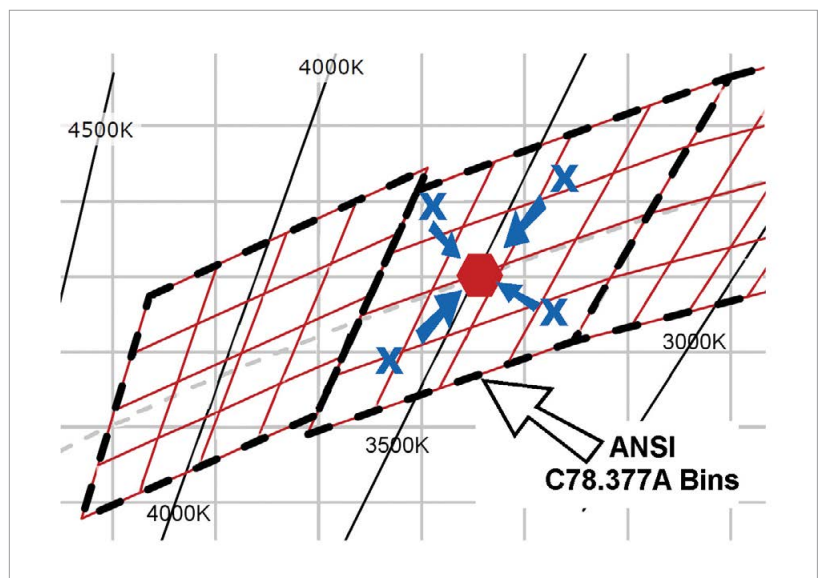
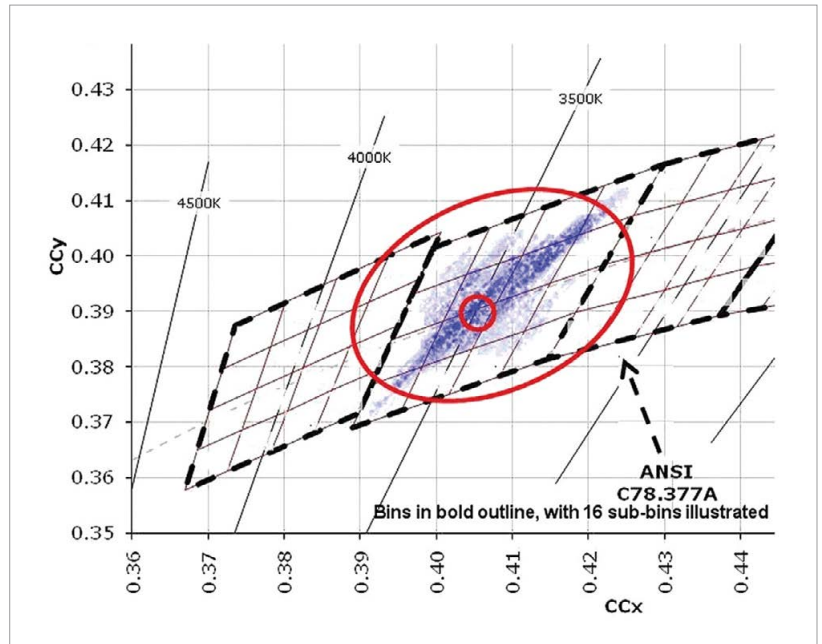

Figure 3:
Symmetrical
distribution

One can naturally expect that the goal of the LED manufacturer is to sell every LED that comes out of a manufacturing run, or basically, sell out all the bins. While the LED manufacturer would prefer to sell from all the bins to all the customers, the somewhat contrasting goal of the lighting manufacturer is to produce a single, consistent color result for any particular luminaire SKU. The simplest approach for the luminaire manufacturer would be to order all their LEDs for a single luminaire SKU from the sub-bin which is closest to that CCT/BBC intersection. Unfortunately, when theory meets reality, reality always wins, and in this case, the luminaire manufacturers taking that approach expose themselves to two challenges:

- Potential supply shortfalls, based upon the variability of LED manufacturing runs; and
- Substantial component cost premiums since the “single-bin” demand is diametrically opposed to the LED manufacturers desire to sell all the bins.

It can be likened to demanding only donut holes, while the manufacturer must necessarily produce whole donuts. If there is only a market for a series of holes, the costs of the “excess” of now hole-less donuts must be supported by those purchasing the holes. If everyone cooperated and purchased all the right “holes” across the whole of the ANSI bin, things might turn out differently, but the applications for the end product are naturally targeted towards those BBC/CCT loci across the breadth of the common color temperatures.

LED manufacturers, recognizing the need to keep prices low and supplies broadly available, have been a valuable source of solutions to the challenge of

hitting the target color point in a cost-effective manner. One approach has been to combine several individual die into a single integrated LED package. With that approach, the LED manufacturer picks individual die from 2 or more sub-bins away from the target color point. If the integrated LED has an ability to allocate differing amounts of drive current to the individual die, then the bin selections can actually be asymmetrical, with the die closer to the target point being driven relatively harder (more brightly) with those further away being driven more gently. The result of either symmetry, or controlled asymmetry, is that sub-bins off the CCT/BBC intersection find a home, and lighting manufacturers will typically find that

Figure 4:
Asymmetrical distribution

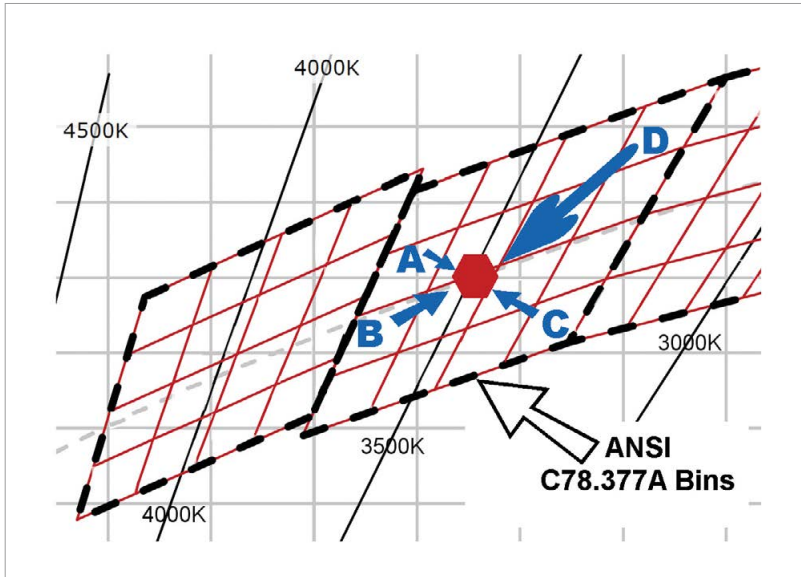

type of integrated LED to have a more consistent supply. The integration effort on the part of the LED producer does command a premium, albeit typically less than the premium for a single, central bin.

This multi-bin concept is fully extensible to luminaires which make use of some form of LED array, and many luminaire manufacturers currently employ a similar strategy of buying LEDs from a number of color and brightness bins that surround the target color point. If all the LEDs in the luminaire will be driven equally (Figure 3), the production engineers will use mathematical averaging to determine which mix of bins create the needed symmetry in a specific manufacturing run. While this does allow the pricing benefits of essentially purchasing “wedges of the donut” rather than just the “holes”, the approach naturally requires the added costs of larger inventories of “symmetrical” bins being on-hand to meet current

production requirements, as well as substantially increasing inventory management and production planning costs.

Still more flexibility can be gained if the luminaire design includes independent drive channels that allow the factory to program varying drive currents for different bin “strings”, based upon their CCT and lumen output, and relative to the other bin strings (each on their own channel) selected for the luminaire. In figure 4, LEDs A and B are nearer the target point than C and D. At the most basic level, LED C is used to “pull” the color point away from A, while similarly D will pull the point away from B. Taking into account the precise binning information and straightforward luminosity and $\Delta u'v'$ calculations, the design or production engineer can calculate the relative drive current needed for each channel to “steer” the output to the desired color point. Solutions can include 2, 3 or more

channels, recognizing the fewer the channels, the fewer the number of bin options that can be incorporated.

Figure 5 illustrates the achievable target CCT area available as the number of channels is varied from 2 to 4.

The programmability option allows the manufacturer the opportunity to specify a wide and variable selection of sub-bins, which adds still more bin tracking and production complications which can at least be partially offset by the cost advantages offered by purchasing still more of “the donut” while perhaps leaving “the hole” to someone else. Whether programmable, or statically determined, the requirement in both cases is that with the carefully tracked bins, determinations on which parts to pick for a production run must be selected based upon inventory availability and mathematically determined bin-pairing according to predetermined boundaries that allow successful mix results.

Add Sensors, Increase Options and Decrease Costs

With the advent of precise, affordable color sensing, a fourth option has opened up that will allow manufacturers to specify a very broad bin selection, optimize component inventories and simplify production management. With this approach, LEDs with varying color points at some distance from the target CCT need only be defined in terms of their relation to the target color point, without regard to the individual sub-bins that make

Figure 5:
Additional bins enable flexibility and precision

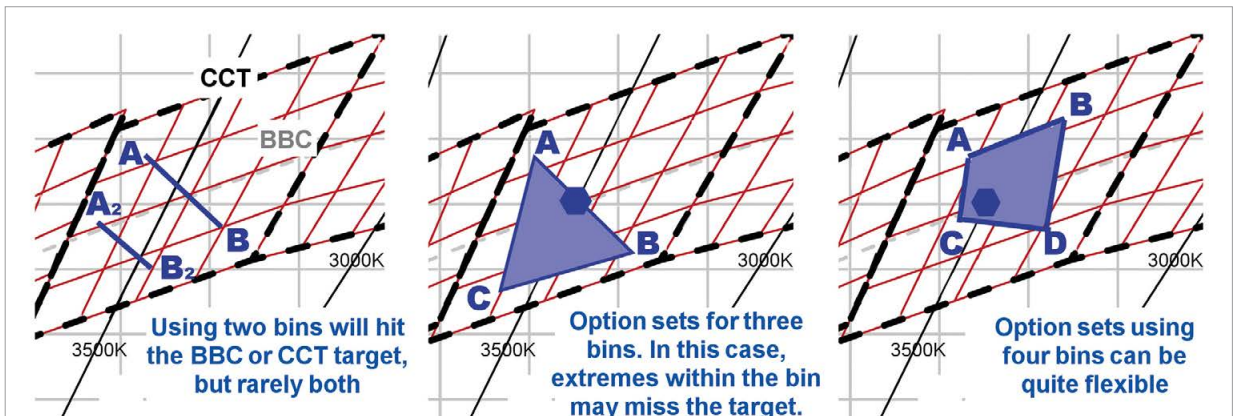
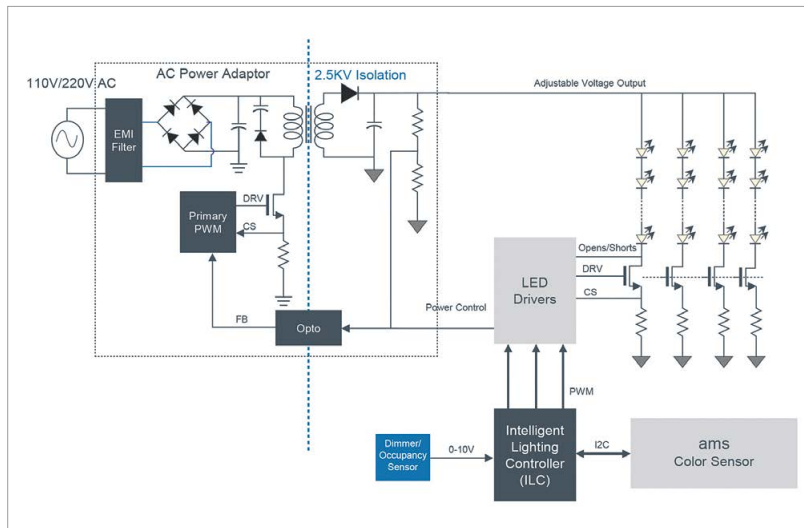

Figure 6:
Multi-channel
color sensing
system
architecture



them up. Referring again to figure 4, the group of sub-bins above and left of the target CCT can be batched for production simply as “the northwest quadrant” and assigned to one of the available driver channels. In the assembled luminaire, the intelligent component of the system (ILC in Figure 6) only needs to know which quadrant of the full ANSI bin that a channel and its component LEDs, represents. Accepting inputs from the color sensor, the ILC will calculate the current combined CCT and overall lumen output and automatically adjust each channel to achieve the target CCT and luminous output.

Since LEDs are instant on/off devices, even the initial color adjustment can be made in the blink of an eye, although most implementations will retain the last-used balance as the starting point for each power-on cycle. Because this is a dynamic, closed-loop solution, the target CCT and output will also be continuously maintained across the range of operating conditions as well as over the entire product lifetime, greatly enhancing user satisfaction. Such an approach can even guarantee a precise color match between older and newer installed units in the event that a luminaire has been damaged or fails after some period of time.

When the initial design is being considered, the system engineer will need to evaluate the sub-bin boundary conditions with regard to the luminosity range for the individual channels relative to the required total lumen output of the luminaire. If, for example,

the luminaire depended upon each channel running at 90% of the rated current in order to achieve the required total lumen output, it will leave only $\pm 10\%$ headroom for each channel to pull the combined CCT towards its own quadrant. That may then imply a need for more symmetry between the mix of bins in each quadrant, possibly constraining the overall wide-bin strategy. Allowing adequate headroom in the design will be a key consideration, and will be determined by the mix of bins that are readily available, priced right, and which can be specified for the different quadrants.

Unlike the other bin-based CCT-balancing strategies, in which specific sub-bins must be purchased, carefully tracked, then paired together for production and driven with predetermined current settings, a dynamic sensor-driven implementation allows manufacturers to make full use of lower cost, or even incomplete, larger bin sets. The fully dynamic approach can even open the door to potentially mixing bins from other qualified vendors, as long as the CCT quadrant relative to the color point is known, and sufficiently constrained with regard to the headroom built into the individual channels.

While not fully unconstrained with regard to binning, all the sub-bin boundary conditions can be made during the initial design, rather than as part of ongoing production and materials planning. The advantage of

such a set-it and forget-it approach to materials selection is obvious, and is very helpful to prevent the “cost creep” that can result from a constant need to create and maintain the more precisely “balanced” LED inventories inherent to the more static mixing methods. Overall, by purchasing much larger bins, effectively “the whole donut”, the luminaire manufacturer could be looking at the potential for LED component cost savings of 25-50%, all while simplifying materials handling and manufacturing processes. Employing a CCT-adaptive type of architecture, which is enabled by precise color sensors, allows this innovative and cost-saving strategy. Cognitive Lighting enables luminaries to have high lumen and color maintenance by sensing CCT or luminance of the luminaire and compensating for the color and lumen drift over time and temperature.

Conclusion: Smart Lighting Is More than Controls

There is more and more talk about the coming wave of “smart” lighting. For anyone with a smart phone, the concepts surrounding flexible networking nodes and connectivity with “the internet of things” is fairly intuitive concerning how it may apply to lighting. It is also clear that Cognitive Lighting will allow an ever-widening capability for our lighting systems to discern environmental, space and user-related parameters. The resulting sensor-enabled adaptive capabilities will allow those systems to fine-tune themselves to complement both the occupants and their tasks. What hasn’t been as obvious is how sensor-driven Cognitive Lighting also enables new paradigms in efficiency for the actual design and manufacturing of our luminaires, all the way down to the component level. Color sensors, in combination with multi-channel drive capabilities and local intelligence, are just one of the many new opportunities for luminaire designers to enhance capabilities while cutting costs and improving system performance both out of the box, and over the life of the installed product. ■

ILLUMINOTRONICA 2014

The unique Italian event trade fair
dedicated to the world
of Solid State Lighting



Save the date
9th/11th October
Padua - Italy

info:

www.illuminotronica.it

LED Light Tile Technology for Lighting and Backlighting

LED Light Tiles are rectangular polymer films with LED embedded inside in a 2-D array. Design LED Light Tile technology is mechanically flexible, transparent and uniquely forms a light-guide with optics integrated onto the film surface. The integration of optics on the surface enables functional, narrow asymmetric beam formation from the tile surface for lighting applications, and a uniform spread of light across the surface for thin and optically efficient backlighting. Dr. James Gourlay, CTO and Technical Director of Design LED Products will benchmark the technology against conventional LED solutions used in lighting and backlighting applications, in particular LED edge-lit technology with focus on system efficacy and form factor and indicate how the technology can be deployed to the best effect.

Light Tile technology integrates LEDs and optics in a thin and mechanically flexible form factor. A proprietary Composite Light-guide [1] device structure is used to embed LEDs into thin, mechanically flexible, transparent films with surface optics, giving an integrated and modular light engine solution. Figure 1 shows a warm white 300mm x 300mm light tile sample, typically >950 lumens. The technology evolved from large area backlight panels for LCD TV backlights (BLU), which were developed as a lower power and lower cost alternative to the conventional edge-lit LED approach [2]. For this application, the advantage of the composite light-guide technology was primarily its higher optical efficiency and the resulting cost. Following the BLU program, the technology has been developed as a light source material for lighting and backlighting. The Light Tile is a product of the technology development and is a functional, high efficiency lighting system. The 90% optical efficiency and narrow asymmetric beam angle capability, with the thin, mechanically flexible, transparent form factor make it very attractive to lighting designers.

General Technical Features

LEDs are encapsulated within the composite light-guide structure and distributed over the Light Tile area. The Light Tile can deploy a range of high efficacy LEDs with high Color Rendering Index (CRI) and range of Correlated Color Temperature (CCT). The high efficacy LEDs are encapsulated in a thin light-guide which is mechanically flexible.

Optics on light-guide surface enables:

- Narrow (>10°) asymmetric beam angle control for lighting
 - Uniform illumination for backlighting.
- LEDs are embedded in 2-D array within multi-layer polymer composite films

The polymer films act as a light-guide structure to spread the light inside the Light Tile by total internal reflection (TIR).

Figure 1:
An LED Light Tile. LEDs embedded inside a polymer light-guide with surface optics integrated

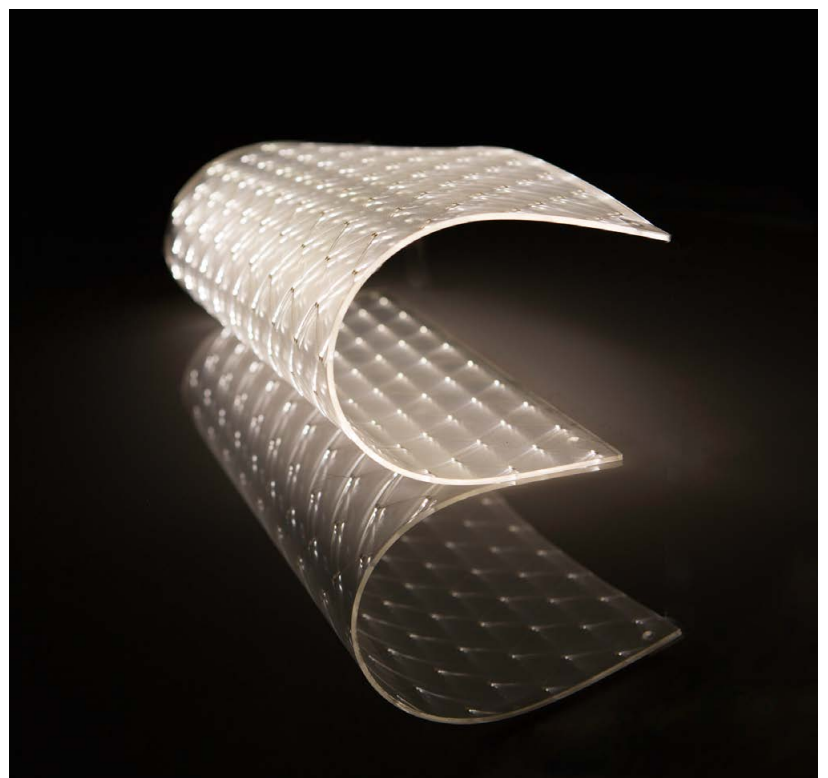

Figure 2:
The cross section device structure of the Light Tile showing design configuration options

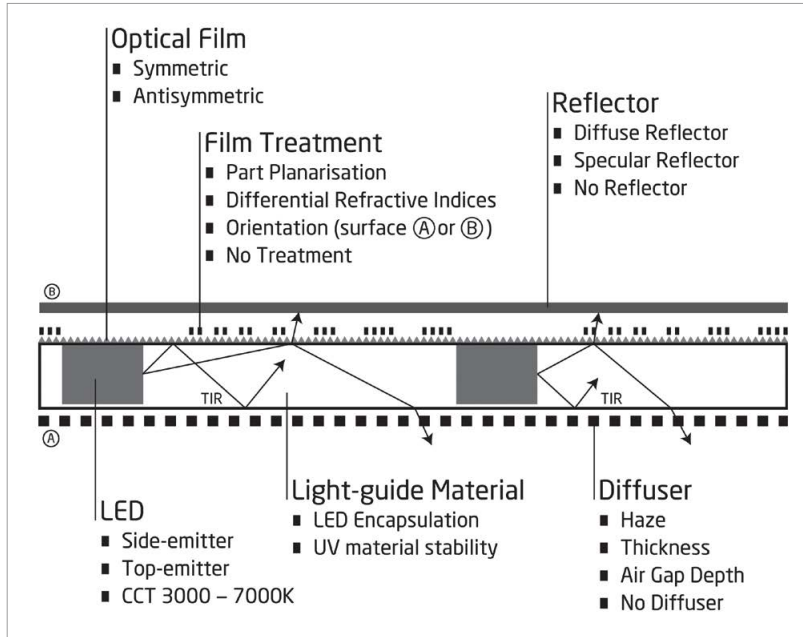

Figure 2 shows a simplified device cross-section and includes some design options and external component options. The transparent substrate has the LEDs mounted electrically and mechanically. The LEDs are encapsulated to form the two layer light-guide structure. The LED light is emitted parallel to the surface of the polymers and is trapped inside the composite layer by TIR. On one or more surfaces of the light-guide structure, located at the air interface, are refractive optical surface features. The refractive optical surface features on the light-guide surface disturb the total internal reflection (TIR) and allow light to escape.

The pattern and form of the surface features controls the

- Illumination uniformity for backlighting applications
- Beam angular distribution profile for lighting applications

For example, high quality prisms and a single LED orientation create a narrow emitted asymmetric beam angle distribution or a regular 2-D pattern of the LEDs distribution. The graded light extraction features can achieve uniform spatial distribution to a backlight graphic or screen. In general, the Light Tile can be transparent and the light output can be single or double sided. The manufacturing process for the panel and the patterning of the prisms is based on screen-printing, with very low tooling costs.

Good thermal management is inherent because the LEDs are distributed across the panel with its large surface area. For example, designs where the LED junction temperature does not exceed 20°C above ambient in a typical installation are achievable. So typically, no external heat sink or spreader is applied. Therefore, the spatial distribution of the LEDs in conjunction with materials and form factor allows the Light Tile to run cool, so no heavy metal heat sink is required.

The solution has a high optical efficiency (~90%), which is around 2 times some edge-lit solutions. The technology has passed standard testing including blue/UV material stability. The solution is OLED-like but with all the standard LED benefits and with added optics, double the efficacy and longer lifetime. The tiles are modular and cutable.

Design Features for Modules

The size, shape, lumen density, and beam angle distributions are all under the control of the designer. Easily customized, the tiles can be manufactured to many sizes and shapes, different colors and diverse brightness depending on the LED density, modular, scalable, customizable, high IP rating, low weight and robustness. Therefore,

as well as enabling standalone luminaires, the bare Light Tiles themselves can provide system level solutions which are suitable for integrating into products like furniture or architectural materials.

Lighting or backlighting modules can have a range of designs. Different shapes and sizes of individual parts of up to 1 m² are possible. For a curved form factor a bend radius of >50 mm is achievable. Luminous flux density of up to 20,000 lumens per m² is possible. A wide range of symmetric and asymmetric beam angles – from narrow (10°) asymmetric to Lambertian can be designed and photometric data is available.

Figure 3 shows an example of double-sided asymmetric beam distribution with two different light distributions emanating from each side of the Light Tile. With the inclusion of reflector film, single or double-sided illumination is selectable. Patterning the refractive light extraction features on the Light Tile surface allow control of illumination uniformity for thin backlighting. High efficacy LED deployment allows product designs in the range of white CCT 3000 K – 7000 K and CRI >85, plus a range of single/mix of colors. Modules are compatible with standard driver electronics and light management materials. There are low voltage (24 V or 36 V DC) or constant current design options where current regulation devices can be embedded in the system. The resulting measured system-level efficacy can be >100 lm/W. Mechanically, parts can have high IP protection with high IP rated connector options and are low weight <3 kg per m².

Figure 3:
Example of photometry achieved by the integrated optics – this can be modified by printing

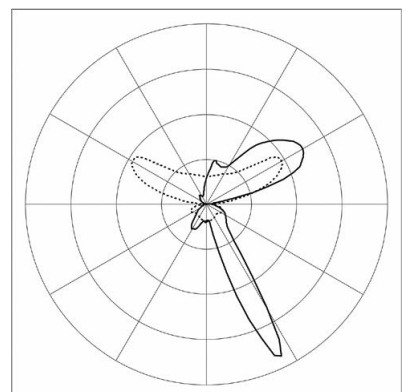

Benchmarking Performance for Lighting: Shelf Lighting

The asymmetric light intensity distribution (LID) capability from the thin form factor is the main technical feature for the lighting application. Mechanically, very flexible, low weight, modular, and transparent solutions are possible where a heat sink/spreader is not necessary. This capability enables “light where you want it” from unique “minimal fixture” designs. An example is shown in figure 4, which shows the result of the illumination from a Light Tile (not visible) embedded into the wooden shelf for a retail lighting application.

This solution has been benchmarked against a wide range of standard LED module solutions, where the following observations were made: Typically, the competitive solutions were >10 mm thickness, with metal housings and external diffuser/optics. On lower specification products, little or no optics were deployed to focus the light where it was required. All of the standard product solutions with optics were rigid. In comparison, the key features of the Light Tile technology solution were:

- Good, shadow free illumination of the product on the shelf, with acceptable color performance
- The narrow asymmetric beam angle distribution efficiently delivers the light to the product, with little wasted, achieving >1000 Lux illumination level on the shelf at less than 7 W/m – comparable standard products were in the >10 W/m range, and
- The tile is embedded into the wooden shelf (enabled by thinness and good thermal management) giving the solution a high level of protection from damage as well as an attractive “hidden” appearance

Delivering the benefits of an efficient lighting system with a thin <2 mm profile, was seen as a unique feature in the benchmarking exercise.

Benchmarking Performance for Backlighting: Signage

Edge-lit LED technology is very effective in delivering thin lighting panels with a Lambertian output beam distribution. Edge-lit LED is the technology that enabled the breakthrough of “LED TV” to the

consumer LCD TV market from around 2008 onwards [3]. Typically, this consists of a PMMA light-guide plate covering the extent of the LCD panel. LED light sources are located along one, two or four edges of the PMMA light-guide plate. The light from the LEDs is coupled with the light-guide plate and guided by TIR. Light extraction features disturb the total internal reflection and allow light to escape. The pattern of the light extraction features supports uniform distribution of escaped light behind the LCD panel, when configured with a rear reflector. In recent years, edge-lit LED technology has been deployed in lighting applications, for example the 600 mm x 600 mm Lambertian ceiling tiles. However, its main advantages of uniformity with a thin system thickness are best deployed for backlighting applications like in signage.

One of the main differences between edge-lit and the LED Light Tile technology is power consumption per area. As the area of the backlight increases, edge-lit LED technology power consumption increases in a non-linear manner due to the increased optical absorption and scattering losses within the light-guide polymer as the distance from edge to center increases. Light Tile power consumption increases linearly with area. For typical signage applications, when the Light Tile technology is benchmarked against edge-lit LED technology and the same LED deployment is assumed, the new technology is up to 50% more optically efficient than edge-lit LED with similar thin system thickness (~20 mm). Optical efficiency equates to lower power consumption, and therefore system cost (LEDs, drivers, thermal management) to achieve the same front of graphic luminance. Additionally, it has distributed thermal management (not concentrated around the edge), is non-rigid, has much lower weight, and is modular.

Where system thickness is not an issue in the range of 80 mm upwards, a range of LED modules (configured in what is known as direct-lit) are

Figure 4:
Example of the technology used in low profile and high efficiency shelf lighting

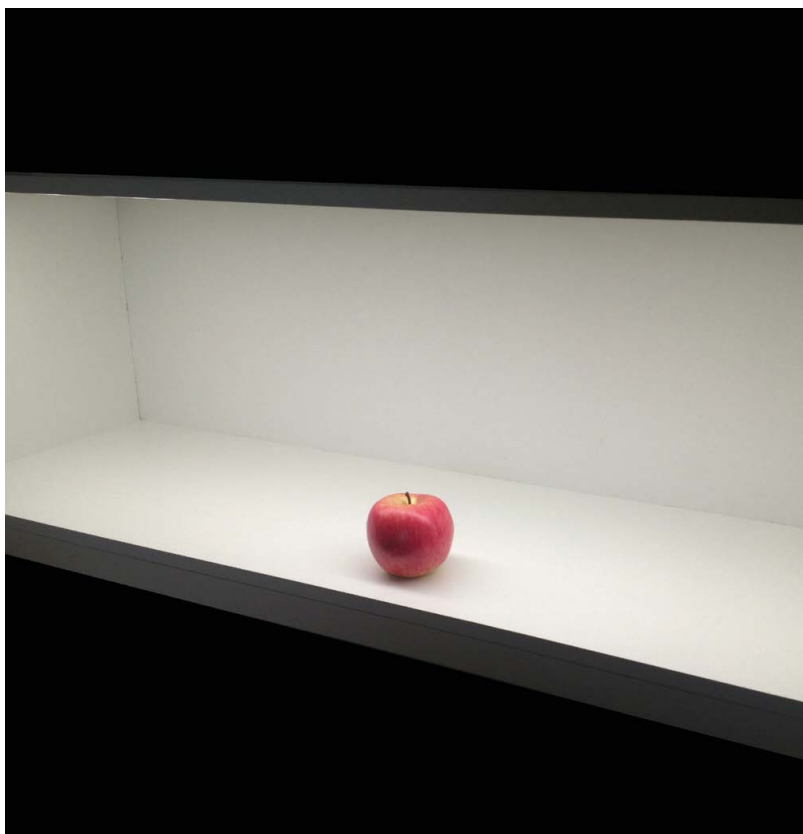

used for backlighting applications. Typically, strong diffusers (as were used with fluorescent tube backlighting) are deployed to dampen the hot spots or non-uniformities generated by the LED modules. The Light Tile technology can join modules to cover large area signage applications. For example, 24 300 mm x 300 mm light tiles were joined to form a 1200 mm x 1800 mm signage system. Where Light Tile technology is deployed for signage backlighting, only weak diffuser components are required to achieve acceptable levels of uniformity. Therefore, energy saving is achieved by reducing the strength of the diffuser component. In benchmarking experiments compared with a range of standard LED backlighting modules, up to 50% more efficiency was achieved by the Light Tile technology. Therefore, deploying the Light Tile technology for backlighting applications achieves lower power consumption when benchmarked against both thin edge-lit LED and thick direct-lit LED. The Light Tile

technology enables lower power, thin (~20 mm) and flexible modular “light box” solutions.

Future R&D – Uniform Light Sheets

The Light Tile device structure (composite light-guide) allows the integration of any light source. Future development of the technology will work with device partners for the integration of next generation LEDs. For example, both microled and nanoled technology offer opportunities for narrow device beam profile to improve light coupling. Therefore, the technology will benefit from device technology developments around the world. The development helps reduce costs further and improve performance. There is the technical potential that enables uniform and diffuse sheets of light that would look like illuminated paper – or be “Organic LED-like”. This would open up a whole new application space for the technology.

Summary and Conclusions

The technology has three main distinct features:

- Form factor – uniquely double-sided and thin/flexible
- Efficiency – integrating high efficiency light sources into a high efficiency system – up to 50% better than other LED solutions
- Costs – the Light Tile is the system, with no requirement for additional optics, metal housing, heat sinking, simple connection and electronics.

The technology has many technical benefits for lighting and backlighting applications – unique form factor, high efficiency and low system cost. ■

References:

- [1] Gourlay J., “Low-Cost Large-Area LED Backlight”, SID Symposium Digest of Technical Papers -- June 2009 Volume 40, Issue 1, pp. 713-715
- [2] Gourlay J. and Miller I., “High Efficiency Hybrid LED Backlight for Large-area LCD TV” SID Symposium Digest of Technical Papers – May 2010 Volume 41, Issue 1, pages 1097–1099
- [3] Choi S.S, “Ultra-Slim TV Module Technology”, SID Symposium Digest of Technical Papers -- June 2009 Volume 40, Issue 1, pp. 720-722



CREE CXA HIGH-DENSITY LED ARRAYS DELIVER UNMATCHED LUMEN DENSITY FOR LIGHTING APPLICATIONS

Four new Cree LED arrays redefine the possibilities for high-intensity LED lighting applications. These Cree® XLamp® high-density LED arrays – CXA2590 (15,500lm/19mm), CXA1850 (9,000lm/12mm), CXA1520 (4,000lm/9mm), and CXA1310 (2,000lm/6mm) – double the light output of existing CXA LED arrays without a size increase, delivering new levels of light intensity, enabling the complete replacement of ceramic-metal-halide (CMH) light sources, and expanding the application potential of LED spotlights. Please visit www.cree.com/cxa to learn more.

CREE 

XLampSales@cree.com

ZigBee Light Link – The Technology for Residential Wireless Lighting Control

Over the years, various solutions for wireless control of residential lighting and other home appliances have been developed. Some of these are based on proprietary technologies, while others are based on open connectivity standards. Products compliant to the same standard are interoperable, though the standards themselves are incompatible. Simon den Uijl and The Technical Advisory Working Group members of The Connected Lighting Alliance (TCLA), gives some insight into ZigBee Light Link and why TCLA recommends it for residential applications.

The residential market appears to be ready for implementation of wireless lighting connectivity. In the upcoming years, this market may develop various non-interoperable product eco-systems, which will create consumer confusion and frustration, and hinder proliferation of the market for intelligent lighting solutions. In addition, supporting different RF standards per region will add cost for the manufacturers and other parties in the supply chain.

When lighting devices converge on a common open standard, the market will be able to function more efficiently, which will benefit the consumer. To grow the market for residential wireless lighting solutions, consumers require affordable, simple-to-use, easy to install, and interoperable lighting products. For this reason, the members of TCLA have studied the market requirements, various open standards, and decided to endorse ZigBee Light Link as the wireless connectivity standard that is best fit for residential lighting applications and controls.

Market Requirements for Residential Wireless Lighting

The starting point for evaluating the different solutions was a list of requirements for the wireless connectivity standards. These were based on the insights of the leading companies in the lighting industry, regarding the important features in terms of technical and market requirements for residential wireless lighting connectivity. The requirements were grouped into two category types: 'boundary conditions' (Table 1) and "other requirements" (Table 2).

Subsequently, both types were further specified in criteria that allowed for benchmarking and scoring. These criteria were differentiated in 'shall' and 'should' requirements

The requirements were defined as:

- Shall: indicates that the standard **must** satisfy the criteria
- Should: indicates that it is **highly desirable** that the standard satisfies the criteria

In table 1 and table 2 the "shall" criteria are listed in regular text, and the "should" criteria are listed in *italics*.

Boundary Conditions	Criteria
Open standard, in accordance with cooperation agreement, that can be leveraged globally	Established by collaborative and consensus driven process, allow for differentiated products, publicly available, accessible IPR, on-going support, global availability/ acceptance, adhere to regulatory aspects
Supported by multiple IC manufacturers	Multi-manufacturer availability of IC, multi-manufacturer availability of network stack, multi-manufacturer availability of application stack
Available (existing standard) for implementation	Available specification
Mature (certification and compliance process in place)	Compliance process, certification procedure, Compliance logo, complete specification

Table 1:
Boundary
Conditions

Table 2:
Other requirements

Other Requirements	Criteria
Lighting features	On/Off Control, Dimming level control, Colored light control, <i>White light color temperature control</i> , Individual control, Group control, Multicast, Scene control, <i>Real-time control</i> , Minimum interoperability, Lamp specification, Controller specification, Logo that guides customer, Standalone Control, Control over Internet
Low complexity	Resource-constrained devices, Cost-effective devices, Extendable solution, <i>Global frequency Band</i>
Energy management and low power consumption	Low stand-by power, Battery powered operation, Long battery lifetime, <i>Energy-harvesting operation</i> , Energy monitoring
Scalable and affordable for consumers	Volume production, <i>Affordable system extension</i> , Installation without professional installer
Easy to install for consumers at home	Interoperable installation, Easy installation, Tool-less Installation, Button-less installation, System extension
Multi-room	Home coverage, At least 50-100 nodes
Secure system	Proven security technology, Security agreements, Credential issuance, Secure installation
Robust performance	More than one channel, Channel selection, <i>No operation-time reliance on special roles in the network</i> , Reliable transmission
Provide connectivity to other home appliances in the residential area	<i>Creation of home control products beyond lighting, Network extension beyond lighting</i>

Best Fit for Purpose

After the requirements were defined, open standards were identified that met the boundary conditions. Subsequently, the open standards were benchmarked on the requirements. This resulted in an overview showing the strengths and weaknesses of the open standards. The outcome showed that none of

the standards was superior on all requirements; each had their strengths and weaknesses. The ZigBee Light Link standard had the overall best score, and could therefore be regarded as the open standard that was best fit for residential wireless lighting connectivity. Table 3 shows an overview of how ZigBee Light Link

scored on the requirements, and a short explanation of the reasoning behind these scores. The actual scores have been omitted, and replaced with the following color coding scheme: green (best compared to other standards), yellow (average compared to other standards), and red (worst compared to other standards).

Table 3:
Overview of how ZigBee Light Link scored on the requirements

Requirements	ZigBee Light Link	
Boundary Conditions	Open standard	At least 9 companies contributed to the ZLL specification development, ZLL is available to all ZigBee Alliance members, and available to the public upon request, all parties involved in ZLL development have agreed to license their essential IPR on RAND conditions
	Multiple IC manufacturers	At least 4 stack vendors offer a certified ZLL solution (IC + application stack)
	Available for implementation	Available for implementation and certification since April 2012
	Mature	Complete specification (transport, application, security and commissioning) and certification process in place
Other Requirements	Lighting features	Comprehensive support for electric lighting features, best interoperability support guaranteed through logo
	Low complexity	ZLL is designed for resource-constrained devices like light bulbs, and fits in to a into a 256 microprocessor
	Energy monitoring and low power consumption	Energy monitoring feature set not yet included in current spec (will be improved in future versions)
	Scalable and affordable for consumers	ZLL supports system extension or home coverage without the mandatory need for additional wiring or range extenders. Installation, operation and control can be done without the need to hire a professional installer
	Easy to install for consumers at home	Touchlink provides simplicity, DIY, and toolless installation, no professional installer required, standardized installation method
	Multi-room	Supports at least 50 nodes or more
	Secure system	ZLL uses enhanced security mechanisms, based on secret keys that are only handed out to officially certified ZLL products
	Robust performance	ZLL supports multiple radio channels, and does not require a controller/coordinator
Provide connectivity to home appliances	Focus on lighting only, connectivity to home appliances is not guaranteed (expected to be improved in future versions)	

A Primer on ZigBee Light Link

ZigBee Light Link (ZLL) is a ZigBee application profile specifically designed for wireless residential lighting applications and control, with a prime focus on needs and requirements from users and consumers in the home, such as “easy to install”, “simple to use”, “out of the box and just works”. ZLL offers a rich feature set to control lighting, from simple on/off and dimming, individual and group control, to color setting features to reflect ambience and mood, etc. Typical ZLL products include light bulbs, lighting luminaires and fixtures, remote control devices, light switches, etc.

The ZLL application profile is based on the common ZigBee Pro standard, which offers global operation at 2.4 GHz ISM band with over-the-air data rates of up to 250 Kbps. ZigBee Pro specifies mechanisms for networking such as network security, mesh routing, and network management. ZigBee Pro enables interoperability to other ZigBee Pro based standards, like ZigBee Home Automation (ZHA). With the aim of ‘easy to install by the consumer’ (DIY), simple to use, simple to add new lighting devices in the ZigBee network, ZigBee Light Link was designed so that no additional controller device is required. The use of additional controllers often makes installation too complex. In technical words: ZLL does not use a central ZigBee coordinator. For example, a ZLL network does not require a central gateway through

which all ZigBee lighting devices are controlled. An example of the most simple ZLL network is a ZLL light bulb (or luminaire) and a remote control to control the light. Adding new lighting devices to a ZLL network, or removing existing lighting devices from a ZLL network – in lighting terminology, “commissioning”, - again is designed with easy-of-use in mind. ZLL supports a feature called Touchlink. Touchlink provides an easy and intuitive installation experience based on the proximity of ZLL devices which is secure and appealing to the consumer market. Last, but not least, in addition to the security mechanism already provided by ZigBee Pro, ZLL is using additional security mechanisms that help consumers and users so that their ZLL home network is protected against unauthorized usage.

Key for the user is seamless interoperability between the ZLL devices in their network. Independent of the ZLL devices type (a switch, lamp, luminaire, remote control, bridge, etc), ZLL devices are always 100% interoperable. ZLL uses a mandatory command set that is supported by all devices, and ZLL devices have been tested against compliancy to the ZigBee Light Link specifications. ZLL device manufacturers have to use third party test houses to prove their compliancy. Only if compliancy is proven, manufacturers can use the ZLL logo (the little orange light logo) on their products and documentation. The logo ensures interoperability to the user, in other words “it just works”.

Key Aspects of the Standard in Detail

Device types

ZLL specifies two general categories of devices - light devices and controller devices. Light devices include on/off light, dimmable light, color light, extended color light, and color temperature light. Controller devices may include light switches (e.g. on walls), occupancy sensors, remote control unit(s), smart phones, computing devices (e.g. PC or tablet). Controller devices can be classified as color controller, color scene controller, non-color controller, control bridge, on/off sensor, etc. Usually, a controller is an end device while a lighting device is a router. A group of lighting devices can form a mesh network for maximum outing flexibility.

Network formation

ZLL defines a coordinator-less commissioning method called Touchlink to form a ZLL network, in addition to the classical ZigBee commissioning method. Under Touchlink, a target device (e.g. a lighting device) is added to the network by a controller device called ‘initiator’, e.g., a remote control unit, which is capable of address assignment. Touchlink simply requires the target device to be physically close, with received signal strength higher than the manufacturer specific threshold, to the initiator device to be included in the network. The joining process is started at the initiator (e.g. by pressing a button). Commissioning involves three sets of command exchanges between the initiator and the target lighting devices: discovery of target devices based on received signal strength; transfer of device information and network settings; and request network formation or join (choosing one target device at a time if multiple found). This operation is repeated for each new lighting device to be joined by the initiator. Touchlink employs inter-PAN communication for commissioning messages.

Figure 1: ZigBee Light Link protocol stack

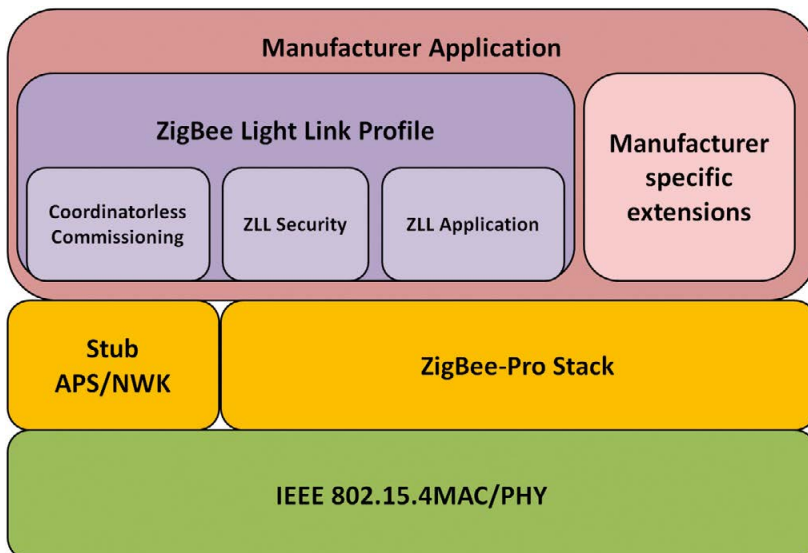

Network addressing

ZLL networks use 16-bit network (short) addresses to identify devices. The assignment of network addresses to devices in a ZLL network is not performed in the same way as in a classic ZigBee PRO network, in that a ZLL controller device, i.e., initiator, facilitates network assignment, from an allocated range of possible addresses. In addition to network address, group identifiers can be assigned similar to network address assignment. Group identifiers are used when addressing a subset of devices using broadcast mechanisms and they are typically used by a controller application residing at a certain endpoint, e.g., remote control unit.

Security

ZigBee Light Link uses a network-level security in which the same network key is used by all nodes in the network to encrypt/decrypt communications between them using 128 bit AES encryption. The network key is generated randomly by the initiator device when the network is formed and is unique to the network. The distribution of this network key to devices subsequently joining the network is secured using the ZLL master key, which is pre-installed in all ZLL-certified devices during manufacture.

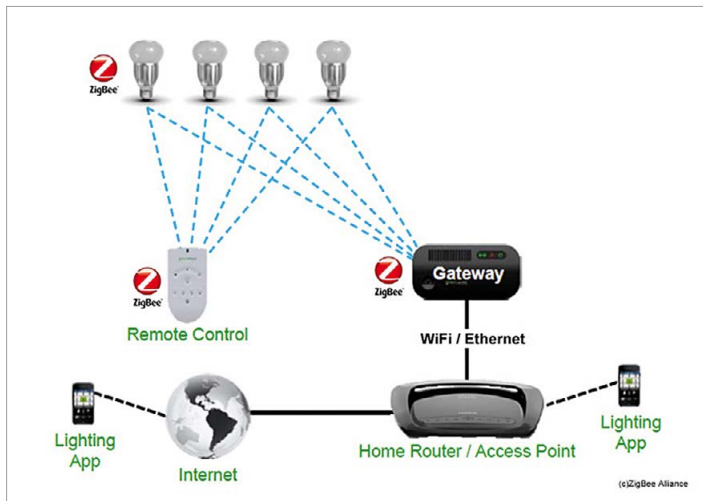

Figure 2: Basic structure of a ZigBee Light Link configuration

Next Steps

Now that TCLA endorsed ZLL for residential wireless lighting solutions, and the benefits of this open standard are increasingly embraced by the lighting industry, the upcoming months will show an increase in the number of companies offering products that support the ZLL standard. With an increase in interoperable products, consumers will have more choice, making wireless lighting solutions more attractive, and resulting in a growth of the total market for wireless lighting connectivity.

Although ZLL is considered the best open standard for residential wireless lighting connectivity, it has areas for improvement. As table 3 shows, the main drawback of ZigBee Light Link is its lack of connectivity with other home devices. The Connected Lighting Alliance has recognized that connected lighting is evolving and could become part of a larger connected home ecosystem. In order to support this evolution, the alliance has set-up task forces aimed to enhance the interoperability between ZigBee Light Link and home automation protocols such as ZigBee Home Automation and ECHONET Lite. ■

CIOE

ufi
Approved
Event

CHINA INTERNATIONAL
OPTOELECTRONIC EXPO 2014

September 2-5

Shenzhen Convention & Exhibition Center
Shenzhen, China



LED Techna

A 360° View
of the LED Industry

Materials & Components / Packaging & Modules
Lighting & Display / Manufacturing & Testing Equipments

YOUR ACCESS TO CHINA'S
OPTOELECTRONICS MARKET

please visit

WWW.CIOE.CN

CHINA INTERNATIONAL OPTOELECTRONIC EXPO ORGANIZING COMMITTEE

Add: Room 607, East Block, Coastal Building, Haide 3rd Road,

Nanshan District, Shenzhen, Guangdong, 518054, China

Tel: +86 755 8629 0891 Fax: +86 755 8629 0951

E-mail: international@cioe.cn

Using Interactive Optimization Utilities to Improve LED Lightpipe Designs

When properly designed and optimized, lightpipes provide uniform illumination, high transfer efficiency, minimum shadowing and glare, simple manufacturing and installation, and flexible packaging. Design engineers who integrate LED lightpipes into their products must adhere to specific requirements for illumination uniformity, color, efficiency, and lit appearance. Dr. Edward Friere, President, and Michael Gauvin, Vice President at Lambda Research Corp., will demonstrate how a new feature to interactively monitor parameter changes can help design engineers with any level of experience with lighting simulation software to produce a design that achieves the target results.

Figure 1:
3D illuminance
on speedometer
needle

Lightpipe design is a challenging process traditionally involving extensive engineering time and costly prototypes, but this process is now made much easier using sophisticated optical design and simulation software. The steps design engineers must complete to achieve their product's performance requirements involve a myriad of variables that must be carefully considered in order to reach the desired end effect. Unlike basic luminaires, the optimization of LED lightpipes is uniquely challenging due to the complexity of using either singular or multiple LED source combinations, geometric shape, as well as surface and material property considerations. Coupling considerations are difficult due to source requirements, PCB constraints, including soldering points and lightpipe mounting structures. Optical considerations for lightpipe designs include etendue, mounting, output specifications, and the lit appearance of the lightpipe.

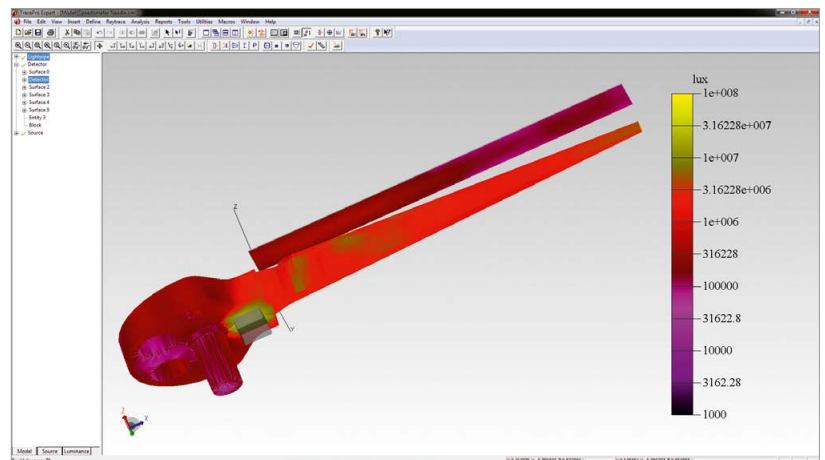

With increased budget pressure on design engineers, the use of simulation software has been proven to reduce costs significantly. This is especially important for lightpipes, which are typically low margin, high volume components. Simulation tools also help to produce designs with reduced manufacturing cost, minimum thermal loading, and improved energy efficiency (Figure 1).

Optical design and simulation tools generally utilize ray tracing principals in which individual light "rays" are traced through the illumination system from source to target taking into account absorption, reflection, refraction, and other principles of optics. Designers

specifically conversant in optical design have been the traditional users (e.g. optical designers) of these tools. Today, however, many design engineers working on lightpipes come from mechanical or electrical backgrounds, and don't necessarily possess the essential optics knowledge and experience to achieve the best results. For this group, software tools that provide a familiar CAD-like interface, and optimization facilities that in effect provide built-in optics expertise, make sophisticated lightpipe design possible. Seasoned optical engineers also benefit from these capabilities, as they are able to refine and optimize lightpipe designs, improving both design efficiency and effectiveness (Figure 2).

Brighten Up Your Business!

www.ledtecasia.com

LEDTEC ASIA 2014

Vietnam Int'l LED/OLED Technology Show 2014

May 8 (Thu) ~ 10 (Sat) SECC,
Ho Chi Minh, Vietnam

Exhibitor Booth Registration Now Open!

Space allocated on first come, first served basis. ~ March 28, 2014



*Register now for prime booth location
at the best marketplace for new emerging LED market!*

Venue :

Saigon Exhibition & Convention Center (SECC)
Ho Chi Minh, Vietnam

Organized by : *EXPORUM*

Supported By :

Vietnam Ministry of Industry and Trade
Vietnam Ministry of Science and Technology
People's Committee of Ho Chi Minh City
Vietnam Chamber of Commerce & Industry
Vietnam Academy of Science and Technology
Vietnam Association of Construction Contractors
Korea Ministry of Trade, Industry and Energy
Korea Trade-Investment Promotion Agency
Korea LED Association

Exhibits:

LED/OLED Material Component
LED/OLED Lighting Fixture
LED/OLED Application
Manufacturing & Test Equipment
Display & Digital Signage

Concurrent Events:

Vietnam Int'l Broadcast & AV Show 2014
Vietnam Int'l Photo & Imaging 2014



LEDTEC ASIA 2014 Secretariat

Korea Office

T +82-2-6000-6677,6671
F +82-2-2051-3326
E info@ledtecasia.com

Vietnam Office

T +84-4-3773-8658/8659
F +84-4-3773-8657
E matt@exporum.com.vn



www.ledtecasia.com

www.facebook.com/ledtecasia1

Figure 2:
Ray visualization
of a curved
lightpipe

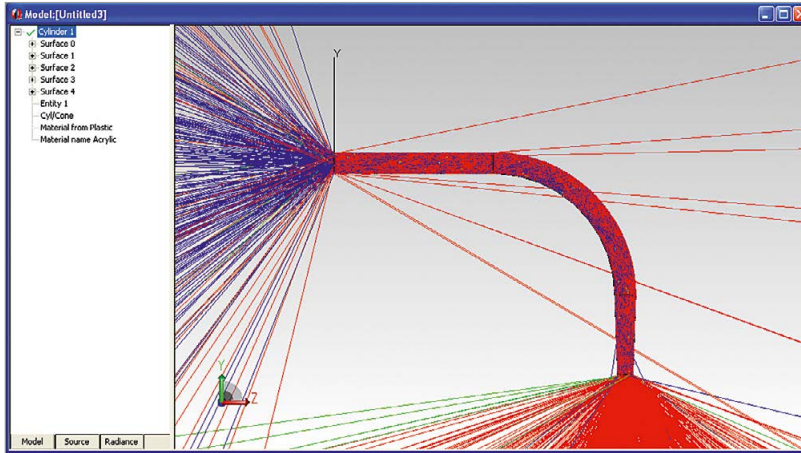

Figure 3:
LED emitting into a
dual output
lightpipe with
output irradiance
shown

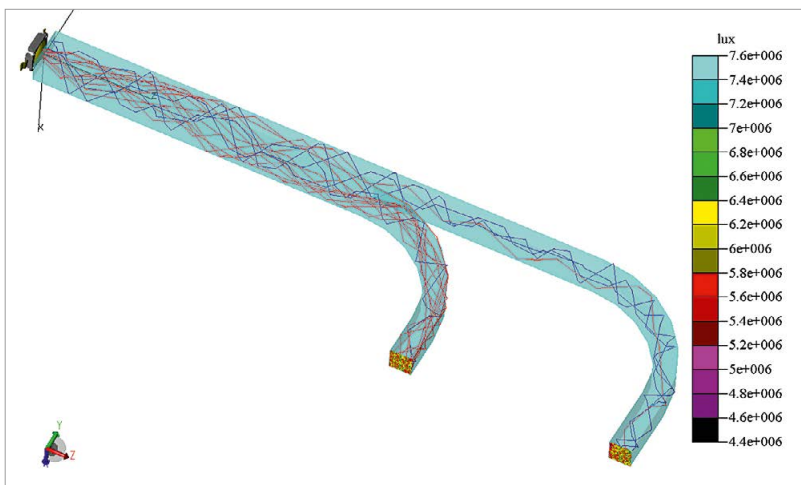
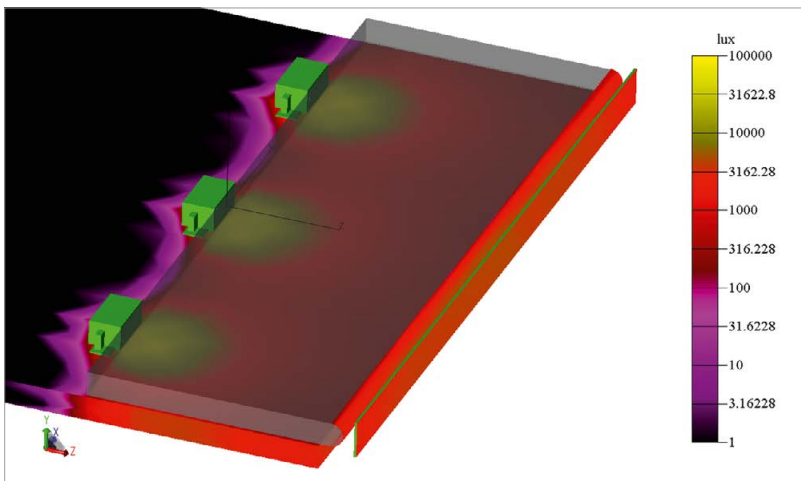

Figure 4:
Edge lit lightpipe
with 3D irradiance
shown on bottom
and output
surface



While full automation of the optimization process sounds attractive on the surface, in practice it is important that the designers have the ability to analyze and adjust design parameters during the optimization process. It's tempting to believe one can simply define a baseline design, establish optimization objectives, press the go button, and presto – out comes the optimal design. In use, however, this often leads to poor and/or non-

manufacturable designs, and wasted resources. Some software tools give the user full control to analyze and make real-time adjustments at every step of the optimization process. Experience shows this to be the most efficient method in terms of resource and time utilization, which will ultimately result in the best design, both in terms of design objectives and manufacturability.

Regardless of the user's level of experience, design engineers should rely upon these fundamental productivity techniques in order to improve results:

- Employ an iterative design process that eliminates time wasted on modeling non-functioning products
- Monitor and adjust optimization parameters interactively to immediately demonstrate how designs are affected
- Make changes to the best performing model among the iterative samples to refine efficiency, uniformity, and brightness
- Review the results of the optimization process to gain insight into how to achieve optimal designs for future products (Figure 3)

Getting Started

The first step in the design process is to establish a baseline design. This can be done using the sketching features available in many optical design software products, or through a mechanical CAD program. The mechanical model is then imported into the optical software for simulation and analysis. Some optical simulation products even offer seamless interoperability with CAD software, allowing for both mechanical design changes in SolidWorks and optical simulation/analysis to be accomplished in parallel. Engineers new to lightpipe design should consider starting with a much simpler design that reduces the potential for errors, though the optimization process may take longer to produce optimal results.

Regardless of the approach, best practice for lightpipe design involves the use of gradual curves that reflect light towards the output, as opposed to sharp curves or 45° bends that fail to act as mirrors and cause energy loss. Design principles involve awareness of Snell's Law, Total Internal Reflection (TIR), and other principles of optics to obtain the desired outcome. TIR occurs, for example, when light strikes a material boundary of the lightpipe at an angle larger than the critical angle relative to the surface normal, and is totally reflected, thus "channeling" light through the lightpipe (Figure 4).

Validating the design with an initial ray trace gives the designer immediate insight into the flaws of the original design, saving valuable development time and eliminating some easily resolved errors before optimization. This initial ray trace can be used to validate the geometry – to confirm TIR at the appropriate locations, for example. This initial step also provides visual confirmation that control and segment variable ranges do not overlap, which greatly reduces the possibility of creating a non-manufacturable design.

Once the baseline design has been created, the designer now specifies target illumination characteristics, material and surface properties, and geometry limitations. For instance, designers can specify a candela profile to obtain a narrow, collimated beam at a particular target location.

Employing Interactive Optimization

In the traditional black box approach to lightpipe optimization, the designer creates a pre-defined starting layout

for the lightpipe, specifies variables and a desired merit function, and then clicks the start button to begin ray tracing and optimization. Once the optimization has started, the designer may have little or no control over the process and may not be aware of the design changes until the end of the optimization process. This often generates a poor and/or non-manufacturable design, frustrating the designer by providing no explanation as to what went wrong or how to correct the problem.

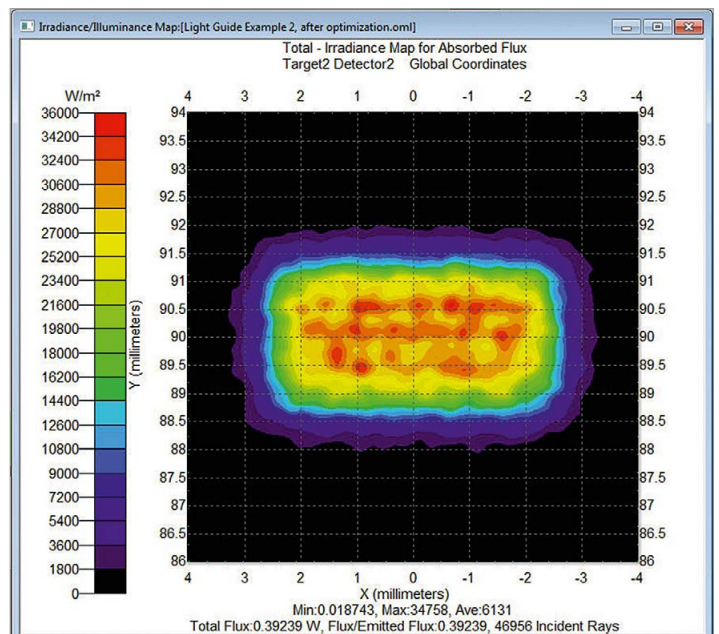
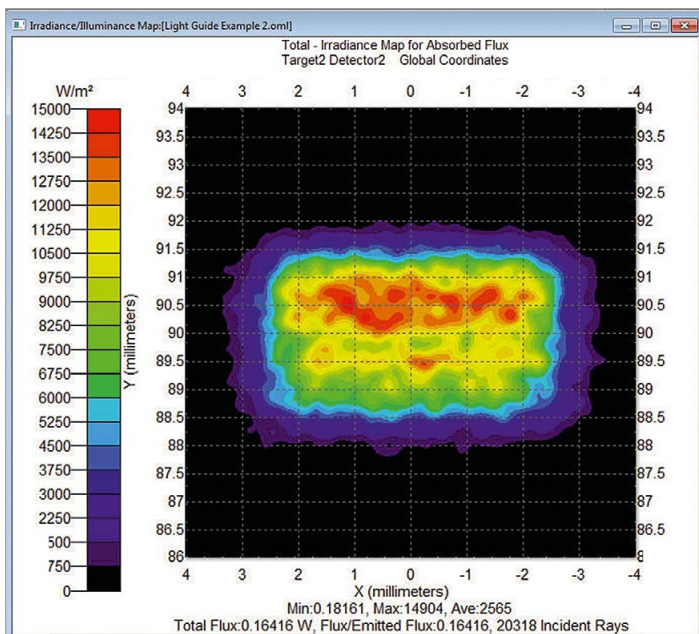
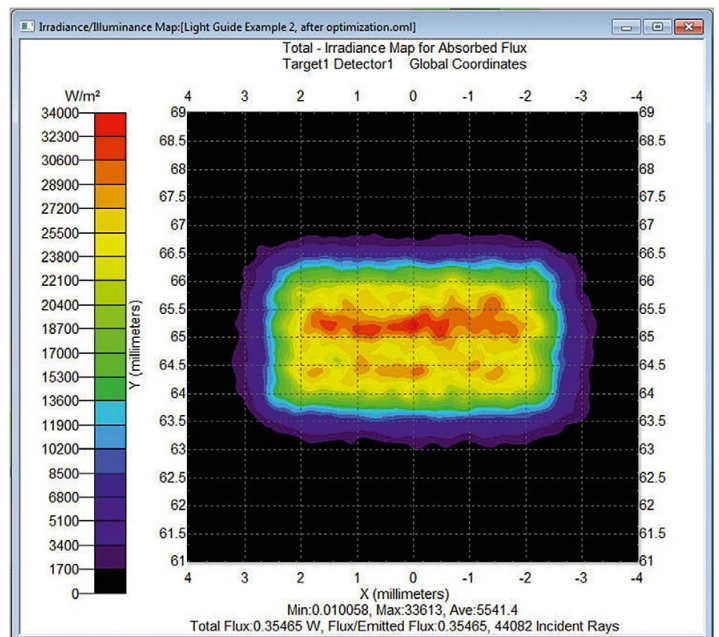
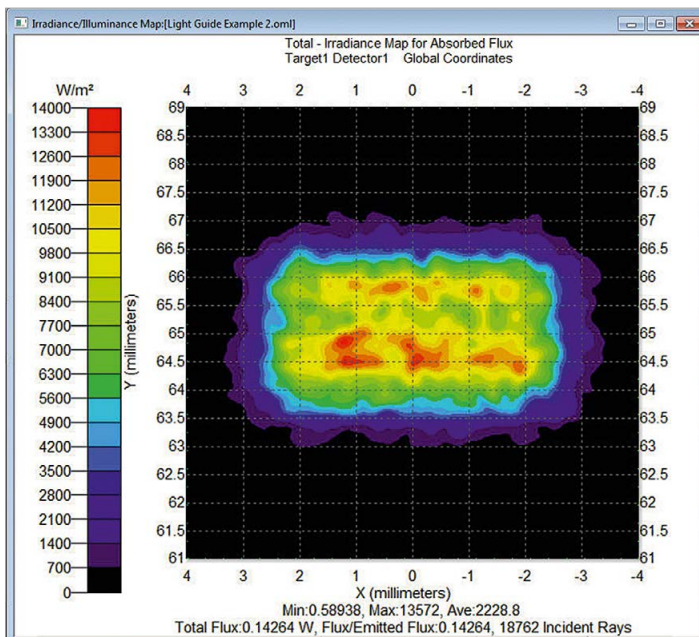

Figure 5 to 8 (top left to bottom right): Pseudo-colored irradiance map on the first output surface of the initial dual lightpipe design. Pseudo-colored irradiance map on the first output surface of the dual lightpipe after optimization. Pseudo-colored irradiance map on the second output surface of the initial dual lightpipe design. Pseudo-colored irradiance map on the second output surface of the dual lightpipe after optimization

Interactive optimization significantly accelerates the iterative design process by starting with better initial designs and using multiple target functions through minimization and maximization of flux, intensity, and irradiance profile targets and spectral requirements. In order to be a more effective method, interactive optimization utilizes a non-linear technique known as downhill simplex, which uses geometric relationships and functional values to find the optimal results.

During the optimization process the design engineer can interactively monitor parameter changes, see how the design is evolving, and make changes in real-time until the highest performing design is reached. By displaying the iterative results, a designer can quickly make changes to their model to improve and refine efficiency, uniformity, and brightness in the software prior to committing to costly prototyping of the product.

Refining Performance

With the first interactive optimization complete, the designer may find that the simulation tool has found the best performing model among the specified number of iterative results. While it is possible to find a model that achieves the desired performance requirements, designers should rerun the interactive optimization process using the best performing model as the baseline.

By tweaking the variables and merit function to refine the efficiency, uniformity, and brightness objectives, the designers can achieve an optimal design that is also cheaper to prototype and manufacture.

Gaining Insight

As the optical design progresses, designers can gain insight as to how the optimal design was achieved by reviewing the iterations as they occur through the optimization process. As noted previously, once the best result has been identified, designers can take that result and use it as a baseline for a subsequent optimization simulation, making further refinements. This approach may also prove useful for the experienced designer who knows how to make minute refinements and serve as an education tool for the engineer learning how to use optimization simulation in their designs.

The process of sketching a design, running a ray trace, and then going through the optimization simulation can be painstaking for the engineer. Luckily, most modern simulation tools have the ability to recall the flux data, irradiance map, uniformity and texture density maps, and other parameters from a previous simulation. By comparing the results from past optimizations, the engineer can speed up this iterative design process, resulting in the best solution for the target values (Figures 5, 6, 7, and 8).

Conclusion

Design engineers who utilize simulation tools with interactive optimization utilities are able to quickly digitize source and geometry information, sketch a starting design, specify variables, and verify that the starting design is meeting performance goals and is manufacturable.

While interactive optimization processes vary from tool to tool, design engineers should look for software that incorporates user-friendly utilities and features that are easily learned and mastered. Design engineers using these tools for the first time require a logical interface that mirrors many popular CAD applications, which makes it easier to produce expedient and accurate models. Similarly, designers need to seamlessly import/export their designs from their CAD software into the optimization software without losing data in the process.

Making the iterative design process as simple as possible equips design engineers with all abilities and power to improve and refine efficiency, uniformity, and brightness before committing to the costly prototyping of a product. ■

15-17

APRIL | 2014

VENUE MOSCOW,
CROCUS EXPO

PAVILION 1, HALLS 1, 2, 3

NEW LIGHT
OF ELECTRONICS

LEDTECH EXPO

ALONGSIDE
THE INTERNATIONAL
EXHIBITION OF ELECTRONICS
INDUSTRY

E·X·P·O
ELECTRONICA

THE 4TH INTERNATIONAL TRADE FAIR
FOR LED TECHNOLOGIES, MATERIALS,
CHIP DESIGN AND MANUFACTURING

Organisers:  primexpo  ITE GROUP PLC

 tel. (812) 380 6003/07/00, ф. (812) 380 6001

 electron@primexpo.ru

www.ledtechexpo.ru



LED professional Review (LpR) - Annual Subscriptions

LpR Digital Magazine

- 6 issues
- pdf download
- high resolution pictures and graphs
- printable
- commercial use
- access to all previous issues
- Euro 78.80

LpR Printed Magazine

- 6 issues
- Euro 158.40

<http://www.led-professional.com/subscription>

Cover-page

Artwork: Thomas Klobassa,
©LED professional 2014

Main Image: Arno Grabher-Meyer,
LED professional

Product: LED package made of
Shin-Etsu's silicone products

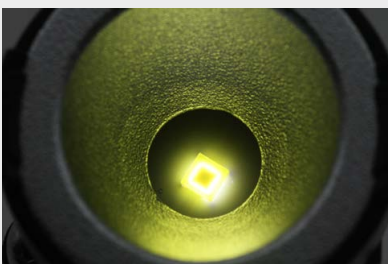

Dimmed white LED with reflector,
making use of Shin-Etsu's phosphor
blended silicone encapsulant and
photo resist coating

Next LpR

Manufacturing & Testing
Issue 43 - May/June 2014 -
Short Overview

Manufacturing: Cost-Effective Next Generation LED Lamp Manufacturing

LEDs top almost every other illuminant when it comes to longevity and performance and unfortunately, in terms of production costs as well. For this reason, advanced, cost-effective manufacturing methods and processes that don't compromise product performance are under development. MID (Molded Interconnect Devices) technology is one of these. It offers considerable freedom for the arrangement of LEDs and much more efficient production with cost saving potential. ■

Manufacturing: Fully Automated Production Lines To Retain LED Manufacturing in Europe

One of the few drawbacks of LED lighting are high initial costs. A good part of these costs are caused by inefficient manufacturing processes, especially manual labor. This is the main reason why manufacturing mainly takes place in China and other Asian countries. Intelligent processes and automated manufacturing lines may bring back manufacturing to Europe and the US, as demonstrated with this example. ■

Special Topics: Key Technologies and Drivers for the Smart Lighting Controls Market

The transition from conventional light sources to LEDs stimulated the controls market and may even disrupt the rest of the building automation industry. This article will show what else is necessary to benefit from this transition, which markets have to be entered and which technologies are relevant for successful entry into these markets. ■

Events: Light +Building Post Show Report

2014 is one of those years where the whole lighting community is waiting for the world's biggest lighting fair. Some information was leaked (targeted or otherwise) before the event and some developments and releases remained secret until the show. The latest technology trends, products and exceptional designs will be covered in this report. ■

subject to change

Imprint

LED professional Review (LpR), ISSN 1993-890X

Publishing Company

Luger Research e.U.

Institute for Innovation & Technology
Moosmahdstrasse 30
A 6850 Dornbirn, Austria / Europe
phone +43 5572 39 44 89
fax +43 5572 20 60 70
info@lugerresearch.com
www.lugerresearch.com

Publisher

Siegfried Luger +43 5572 39 44 89-70
s.luger@led-professional.com

Editor-in-Chief

Arno Grabher-Meyer +43 5572 39 44 89-18
a.g-m@led-professional.com

Int. Account Manager

Theresa Koenig +43 5572 39 44 89-20
theresa.koenig@led-professional.com

Marketing & Sales Manager

Katharina Fink +43 5572 39 44 89-43
katharina.fink@led-professional.com

Your Local Contacts

China, Hong-Kong

Iris Yuen +86 1380 27 01 367
irisyuen88@gmail.com

Germany

Armin Wezel +49 30 526 891 92
armin@eurokom-media.de

Japan

Eiji Yoshikawa +81 3 6751 0090
scala@s3.dion.ne.jp

South Korea

Jung Won Suh +82 2 78 58 222
sinsegi-2@sinsegimedia.info

Switzerland

Monika B. Ailingner +41 41 850 44 24
m.ailingner@marcomedia.ch

Taiwan

Leon Chen +886 2 256 81 786-10
leon@jkmedia.com.tw

United Kingdom & France

Zena Coupé +44 1923 85 25 37
zena@expomedia.biz

US East

Karen C Smith-Kernc +1 717 397 7100
KarenKCS@aol.com

US West & Canada

Alan A. Kernc +1 717 397 7100
AlanKCS@aol.com

Copyright - Luger Research e.U.

The editors make every reasonable effort to verify the information published, but Luger Research e.U. assumes no responsibility for the validity of any manufacturers, non profit organisations or individuals claims or statements.

Luger Research e.U. does not assume and hereby disclaims any liability to any person for any loss or damage caused by errors or omissions in the material contained herein, regardless of whether such errors result from negligence, accident or any other cause whatsoever. You may not copy, reproduce, republish, download, post, broadcast, transmit, make available to the public, or otherwise use LED professional Review (LpR) content without prior written consent from Luger Research e.U. - Institute for Innovation & Technology, Austria. ■

LpS 2014

LED SYMPOSIUM
professional +EXPO

INTERNATIONAL
4th
LED professional
Symposium +Expo

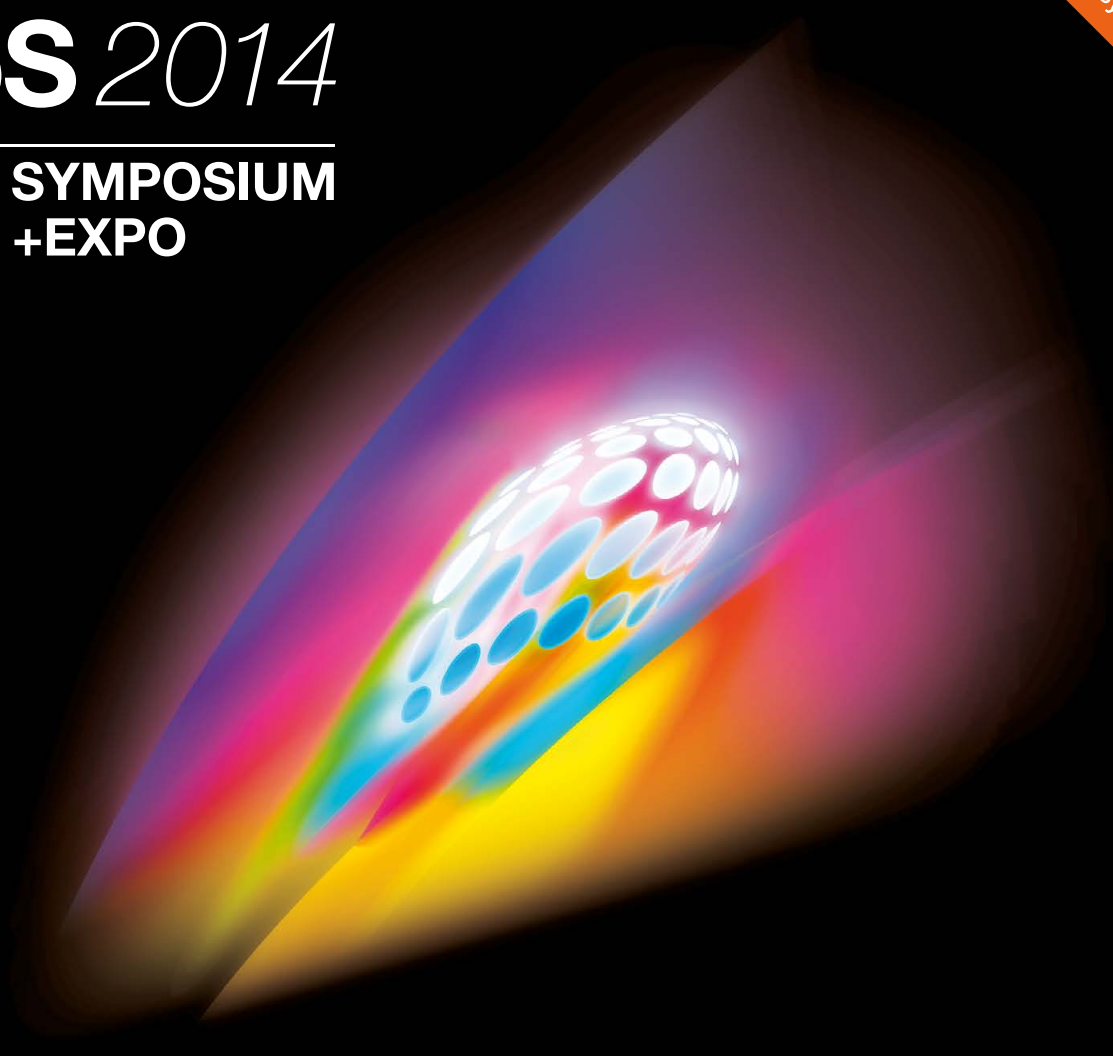

LED & OLED

Lighting Technology

SEPT 30TH - OCT 2ND 2014

BREGENZ | AUSTRIA

info@lps2014.com | www.lps2014.com

powered by Luger Research e.U.

Small is Big



For Manual and
Automated Wiring Systems
2060



For Direct
Power System Feed-In
2061



For the
Smallest Sizes
2059

The Range of SMD Terminal Blocks

www.wago.com/SMD

The WAGO logo consists of the word "WAGO" in a bold, green, sans-serif font. The letter "A" is stylized with a white diagonal slash. To the right of the word is a registered trademark symbol (®).

WAGO®