

International Year of Light 2015

Tech-Talks BREGENZ: Daniel Doxsee

Wafer Level Packaging

Thermal Management of LEDs

We create light because
it allows us to see the beauty
most often overlooked.
See more.

For years, we've been the world's leading creator of light engine technology. Innovation, quality, and reliability drive everything we do. Today, we're proud to reintroduce ourselves as a uniquely focused company, dedicated to shaping the future of light and helping our customers illuminate the world.

lumileds.com





Cost & Manufacturing Issues

Nowadays, next to basic system engineering topics, Solid-State Lighting technologies are evolving very quickly and important manufacturing and cost issues are becoming more and more relevant.

From a cost point of view there is a clear trend to package-less light sources. This was emphasized in our Tech-Talks BREGENZ interview series where Mr. Daniel Doxsee explained Nichia's latest approach for their next generation products.

Besides eliminating costly packages, overall cost reductions are mainly driven by increasing LED performance and efficiency and optimizing the manufacturing processes - in particular - the yields. On a substrate level, the two major technology approaches for reducing costs are replacing the sapphire substrate with silicon (which targets the material costs), or with GaN material (which mainly targets the production yields and the number of used devices). Starting with the highest and going down to the lowest current densities, the substrate materials competing with each other are GaN, SiC, sapphire and silicon. The newer technologies will have to improve a lot to reach the performance levels of the current, commonly used technologies.

Looking beyond the component level of the light-sources itself, miniaturization and integration is going forward quite rapidly and this results in lower material costs. However, the optimization of the overall system and module manufacturing processes play an important role. The "3-Pad LED Flip Chip COB" article by Dr. Pao Chen, R&D Manager at Flip Chip Opto, in this edition of LpR, describes optimization of a luminaire's lumen-per-dollar value through enhanced optical output, smaller heat sinks and optics and the use of fewer LED chips.

We have now entered the phase of optimization for solid-state lighting technologies. It starts at the very deep end, on the chip level and goes through all the steps on the value chain right to the system integration or application of light into buildings. The big increase of new opportunities with SSL, adapting light on a spectral level per application, for instance, goes hand in hand with an enormous effort to increase the system value by lowering the costs and improving performance.

Every single system element has to be verified, optimized or eliminated in order to improve the overall SSL system. In addition, the costs of materials, the manufacturing costs and the economy of scale will play a dominant market role as we've seen in several other industries.

In addition to manufacturing and cost issues you'll find interesting articles on other relevant topics in this issue.

Have a great read.

Yours Sincerely,

A handwritten signature in blue ink, appearing to read 'Siegfried Luger', written over a horizontal line.

Siegfried Luger
CEO, Luger Research e.U.
Publisher, LED professional
Event Director, LpS 2015

COMMENTARY

06 A Confusing Situation that Demands Solutions: Performance Specification
by Jacob Nuesink, DEKRA Certification

EVENTS

40 First EBV Lighting Academy Summary Report
by A. Grabher-Meyer, LED professional

TECH-TALKS BREGENZ

48 Daniel Doxsee, Deputy Managing Director – Nichia Chemical Europe GmbH
compiled by Dr. A. Prasad, LED professional

RESEARCH

54 A Self-Compensation Approach for Maintaining the Chromaticity
Coordinates of Phosphor Converted LEDs Upon Temperature Variations
by Wolfgang Nemitz et al., Joanneum Research

TECHNOLOGIES

62 3-Pad LED Flip Chip COB
by Pao Chen, Flip Chip Opto

66 Practical Estimation of Materials and Measures for
Thermal Management of LEDs
by Giles Humpston, Cambridge Nanotherm

70 Analytical and Numerical Studies on the Influence of the Thermal
Conductivity of TIMs on the Case Temperature of LED Systems
by Vinay Pal, Nikhil Aggarwal & Rajeev Jindal, Moserbaer

REGULARS

03 EDITORIAL
08 PRODUCT NEWS
33 RESEARCH NEWS
34 EVENT NEWS
36 IYL 2015 NEWS
82 ABOUT | IMPRINT

IYL 2015

36 Zumtobel Group IYL 2015 Event
38 SunnyMoney - Life is Getting Brighter

LEADING ARTICLE

48 Tech-Talks Bregenz with Daniel
Doxsee from Nichia Chemical Europe
compiled by Dr. Amrita Prasad,
LED professional



ADVERTISING INDEX

LUMILEDS	2	ELLSWORTH ADHESIVES	24	LED PROFESSIONAL / IP-NEWSLETTER	39
LEDFRIEND	5	FISCHER ELEKTRONIK	25	HONGLITRONIC	45
BICOM	7	FUHUA	26	ELECTROLUBE	53
INFINEON	9	EVERFINE	27	LED LIGHTING TAIWAN	57
LEDLINK	11	REFOND	29	GUANGZHOU INT. LIGHTING EXHIBITION	61
CREE	13	HONGLITRONIC	30	INT. LED & LIGHTING EXHIBITION	65
EPISTAR	15	INSTRUMENT SYSTEMS	30	LED CHINA	69
RECOM	17	CREE	30	LED PROFESSIONAL / LPR	72
SHINYU LIGHT	19	BICOM	30	CHINA INT. OPTOELECTRONICS EXPO	75
EDISON	19	VOSSLOH-SCHWABE	31	LED & OLED EXPO	79
INSTRUMENT SYSTEMS	21	LAMBDA RESEARCH	32	ILLUMINOTRONICA	81
UNDERWRITERS LABS	22	DANGOO ELECTRONICS	33	DIGI-KEY	83
LEXTAR	23	LED PROFESSIONAL / LPS	35	WAGO	84



Regional Sales Agent Wanted!

The Compass of Super-High Quality LED Drivers

To light up one third of the world

Aluminum Casing 10W-65W LED Drivers

1. Rated input voltage AC100-277V. Output power range: 10W-65W, main promoted output voltage range 27-40V.
2. Two shapes aluminum cases: a) low-profile (W x H = 30 x 21mm) shape; b) rectangular shape: L x W x H = 188 x 85 x 34mm.
3. Active power factor correction, high PF (PF > 0.90 @ 230Vac); low THD (THD < 13% @ 230Vac).
4. Meet the Class 1 and Class 2 LED lights' design standards.
5. Surge level: L-N: 2KV, L/N-GND: 4KV.
6. Three different versions: common type constant current LED drivers (LF-GMR***YA series), 1-10V, PWM and Rx dimmable functions are integrated in one product (LF-GMD***YA series, dimming range is 10%-100%.); high-performance flicker-free (LF-GMR***YS series, output voltage ripple < 1V, output current ripple < 3%).
7. Designed for application of LED tri-proof lights, grid lights, panel lights and etc.
8. ENEC, CE, RCM, UL, FCC, PSE, CCC standards.



Plastic Casing 10W-50W LED Drivers

1. Economic design, high performance but economical cost.
2. Output power 10W-50W. AC200-240V input, specifically designed for European, Australian and China markets.
3. Plastic covers, both screw terminal blocks (IP20) and female and male connector cable version (IP60) are available.
4. Low harmonics (THD < 10% for samples and < 15% for mass production).
5. Lifetime 25,000 hours and 50,000 hours version under temperature of 40°C are both available.
6. Applied for LED down lights, ceiling lights and panel lights, and etc.
7. CE, CB, TUV, RCM certifications.



2015 Guangzhou International Lighting Exhibition
Date: 9~12th June, 2015
Booth number: 12.2 D10

Shenzhen Ledfriend Optoelectronics Co., Ltd (Headquarter)

Tel : +86-755-83739299 Fax: +86-755-83739228
sales@ledfriend.com www.lifud.com

Add. : Building B, Jiahua Industry Park, Xinpotou Village, Guangming New District, Shenzhen CN-518107.

Sichuan Ledfriend Technology Co.,Ltd (Production Base)

Add. : Tengfei 2nd Road, Shigao Economic Development Zone, CN-620564 Reshou County, Sichuan Province, China.



Jacob Nuesink

Mr. Nuesink studied electrical engineering and electronics. He started his employment as an engineer for lighting and advanced through roles as a project manager and team manager to the current position of Global Account Manager / Business Developer Lighting for DEKRA Certification B.V. His main tasks are the development of new services and improving existing services for the lighting market as well as coordinating the global market approach to lighting and account management for key customers.

A CONFUSING SITUATION THAT DEMANDS SOLUTIONS: PERFORMANCE SPECIFICATION

Product innovations are not the only consequence of recent advancements in the lighting market. These changes must be accompanied by a realization that the “old” methods for specifying the performance of lighting products no longer fully apply and need to be amended. From the perspective of DEKRA, an organization specialized in the testing and certification of SSL products, the current situation shows the following picture:

Lighting performance has traditionally been measured based on international standards. However, in view of the emergence of solid-state lighting (SSL), many of the existing standards lack relevant testing methods or no longer give adequate results. Changes are already being made to some standards. CRI offers the prospect of a solution since new standards are being prepared and drafts look promising.

Many other standards do not fully address the new market needs for testing. The LM80 standard, used worldwide for lifetime testing, necessitates a minimum of 6,000 hours (9 months) of testing. Nowadays, in view of the pressure to reduce time to market, development times are down to 6 months or less, which means that testing is not complete when the next generation of products is ready for launch. Furthermore, longer testing times are necessary if manufacturers are to make accurate long-term projections. Therefore, reliable highly accelerated testing standards are needed. Europe was lagging behind but the new IEC performance standard is in the process of adopting LM80 testing requirements (by late 2015).

In terms of other challenges, the issue of glare is a common sticking point. The existing standard was not written with today's high-intensity point sources in mind, resulting in a degree

of discrepancy; some luminaires may be classed as “low glare” according to the standard despite emitting a considerable degree of glare. Solutions are urgently needed here.

The new technology also poses some problems. For example, some SSL includes the use of pulse width-modulated currents, which has made flicker a major issue with potentially serious health concerns. Here, science is only starting to scratch the surface and the lack of scientific data forms the biggest obstacle to developing new standards. In another example, studies show that insects leave their habitat when certain light is present at night, so that light source is apparently disturbing nature. As with all new technology, it will take time for the long-term effects to become apparent.

Smart lighting also deserves more attention. Cybercrime is on the rise in relation to society's growing dependency on computers, and systems require proper protection. Hackers could switch off the power in a smart building, like a hospital, or even an entire city, with potentially serious consequences. Hence, cybersecurity is becoming an increasingly pressing issue.

The development of clear international standards is in the interest of manufacturers, suppliers and end users alike. Companies are much more credible when explaining their unique selling points based on an industry standard rather than their own research. Meanwhile, for end users, standards enable true comparisons based on objective and independently verified test results. Standards are not aimed at obstructing innovation and advancement, but rather at facilitating the adaptation and further development of new technology – efficiently, transparently and above all safely. ■

J.N.



LED Tube Cover

Single Lens



Reflector



LED Bulb Cover



Streetlight Lens

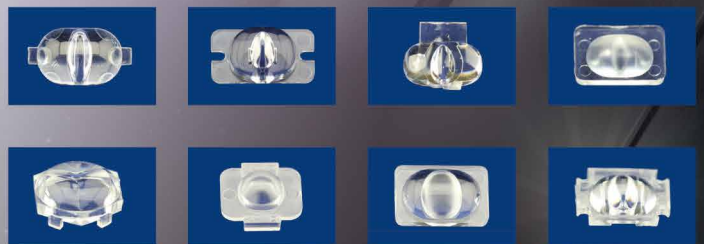

BICOM

Professional LED Lenses & Reflectors Manufacturer

- Develop over 100 new products monthly
- Cooperate closely with Osram, Philips, Cree, Nichia etc.
- Have rich industry experience in optics design and manufacture
- Finish a new optical design within 3 days&Trial-mould samples in 5 days
- Provide high efficiency LED Lenses, Reflectors, Tube& Bulb Covers



www.bicomoptics.com

SHENZHEN, CHINA

TEL: +86-755-29199996

FAX: +86-755-82033711

HONGKONG

TEL: +852-39216016

FAX: +852-27837978

SHANGHAI

TEL: +86-21-33634169

FAX: +86-21-33634512



ADD: B4 BUILDING, XINJIANXING INDUSTRIAL PARK, FENGXIN ROAD, GUANGMING DISTRICT, SHENZHEN

Email: sales@bicomoptics.com

Cree's New High Intensity Class of LEDs Doubles Performance

Cree, Inc. announces the new XLamp® XP-L High Intensity LED, the first single-die LED to deliver over 100,000 candela with a 50 mm diameter optic at 10 watts. Built on Cree's breakthrough SC5 Technology™ Platform, the XP-L High Intensity LED delivers more than double the candelas of the industry's previous highest performing single-die XP-L LED through the same optic. Leveraging the existing 3.45 mm x 3.45 mm XP-L package, the new high intensity LEDs allow lighting manufacturers to quickly boost performance, reduce size and lower system cost for applications such as track, outdoor and stadium lighting.

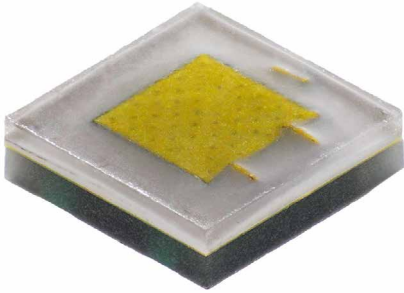

Cree's new XLamp® XP-L High Intensity LEDs, the first of a new class of High Intensity LEDs optimized to deliver double the candelas of previous single-die LEDs

Featuring Cree's innovative new primary optic design that radically reduces optical source size by more than 50 percent, the XLamp XP-L High Intensity LED delivers unprecedented candela at 185 lumens per watt at one watt. The new High Intensity LED offers a drop-in ready upgrade for XP-based luminaire designs, enabling manufacturers to achieve higher luminous intensity with minimal redesign to accelerate time to market.

"The XP-L High Intensity LED looks like a great option for some of our upcoming lights," said Jon Quenzer, Electrical Engineer, Trek. "The XP-L High Intensity LED allows us to boost the efficacy and intensity of our XP-G2 LED based designs without changing optics or drivers."

"The XP-L High Intensity LED exemplifies Cree's commitment to relentless innovation by delivering both lumens and unprecedented intensity in a small form factor," said Dave Emerson, vice president and general manager for Cree LEDs. "The XP-L High Intensity LED will allow lighting designers to

fundamentally change the way they think about using LEDs in high intensity lighting and enable lighting manufacturers to reach performance levels previously not possible."

Characterized and binned at 1050 mA, 85°C, the XP-L High Intensity LED is available in up to 90 CRI and color temperatures ranging from 2700 K to 8300 K. 6,000 hours of LM-80 long-term testing data is available for the XP-L High Intensity LED for lighting manufacturers seeking Energy Star® qualification.

The XLamp XP-L High Intensity LED is built on the breakthrough SC5 Technology™ Platform. ■

New Lumileds Luxeon - The Most Cost-Effective, Compact CoB Range

Lumileds launches its most cost effective line of chip-on-board (CoB) LED arrays with industry-leading punch and efficacy. The Luxeon CoB Compact Range further strengthens Lumileds' lead in the CoB category enabling the most cost competitive solutions for PAR, GU10 and MR16 lamps. This line of arrays is also distinct in that the same optic can be used for both a 35 W equivalent and a 50 W equivalent GU10 or MR16 lamp, thereby reducing system cost and development effort to the manufacturer.



The Luxeon CoB Compact Range delivers ultimate "punch" and efficacy for retrofit lamps and spotlights of 1000 lm

"The Luxeon CoB Compact Range is designed to deliver unsurpassed center beam candle power (CBCP) making it the ideal choice for designers of PAR lamps and other compact directional lamps," said Ahmed Eweida, Product Manager. The range of 5 W, 7 W and 9 W CoBs produce between 600 and 1100 lm at 110 lm/W, making 100 lm/W GU10, MR16, PAR 16 and PAR30 equivalents a reality.

With this introduction, Lumileds extends its lead in the CoB market with its combination of high efficacy, high flux, and small LES (light-emitting surface) of 6.5 mm, enabling high punch at low beam angles. "In a GU10 lamp, the Luxeon CoB 109 achieves 70,000 candelas and 1,500 lumens with a 10° beam angle," said Eweida.

The Luxeon CoB Compact Range 109 will also be available with CrispWhite Technology, the LED innovation that revolutionized retail lighting by revealing the richest whites, vibrant reds and colors that pop.

Lighting designers are using Luxeon CoB Compact Range arrays to produce their most cost competitive retrofit and directional lamps for retail, home and hospitality applications. Lumileds has worked with several key ecosystem partners, for the CoB family, to release compatible drivers, optics and holders to help speed the time-to-market of all lamps. ■

Edison Opto Introduces New Components for Different Applications

The internationally renowned LED-packaging manufacturer, Edison Opto, introduces the new high voltage SMD LEDs that include 3030 HV (1.5 W 45 V) and 5050 HV (12 W / 60 V / 65 V). The Edison HV series features high lm/\$ and high luminous efficiency. For example, the 3030 series can achieve 190 lm under 1.5 W 33 mA (equivalent to 130 lm/W). In addition, the 5050 series can reach 360 lm under the operation of 2.7 W 60 mA and deliver the best performance of 150 lm/W under 1 W 20 mA.



Edison Opto's latest completion is a variety of high efficiency and low cost components to meet customers' lighting demands

The high voltage and low current operation of the new product lines decrease the complexity of circuit and mechanical design

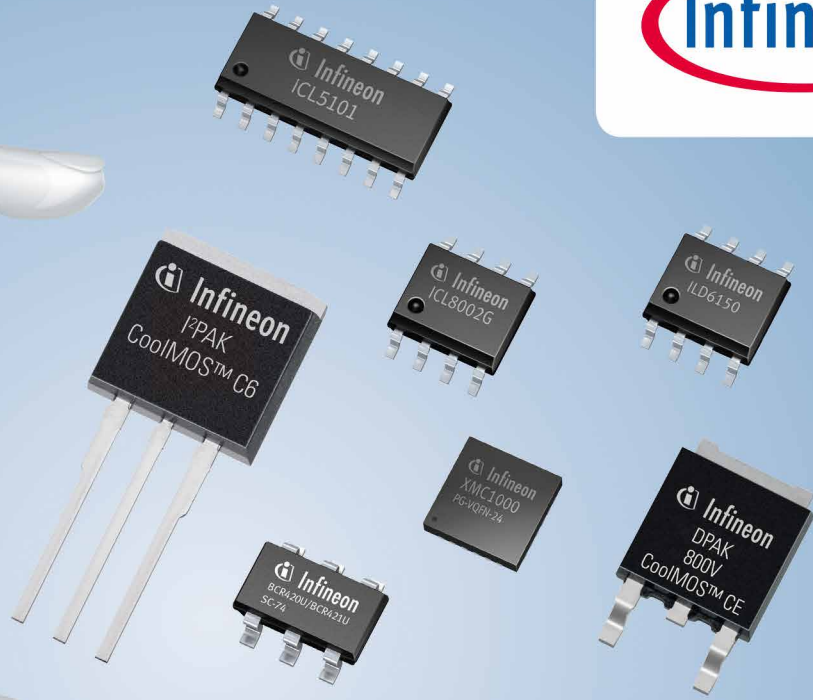
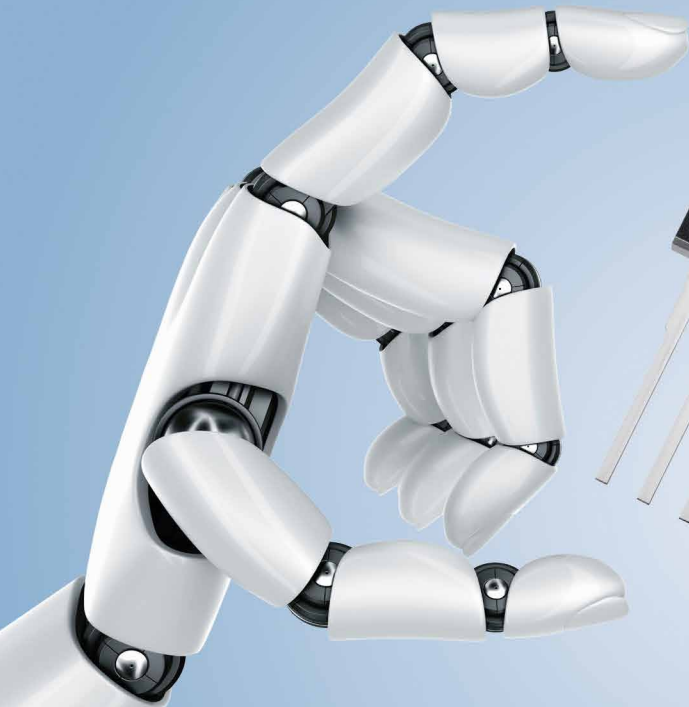

Visit us at Guangzhou
International Lighting Exhibition
hall 12.2, booth E49

Lighting Solutions for LED

Setting New Standards in Energy Efficiency



Infineon's energy-efficient LED Lighting introduces a new era in Lighting applications. Existing Lighting solutions become more energy efficient with dimmable and non-dimmable LED retrofit lamps. For your LED driver we provide you best-in-class LED driver ICs and a full portfolio of high and low voltage Power MOSFETs. Even drive multiple strings of LEDs with either our DC/DC LED driver ICs or with linear LED driver ICs.



Infineon offers a broad range of products and solutions:

- LED Driver ICs with thermal protection for professional indoor and outdoor lighting
- Low-cost LED driver ICs for LED retrofit lamps
- Comprehensive portfolio of high-voltage (CoolMOS™) and low-voltage Power MOSFETs (OptiMOS™)
- Microcontroller XMC for Smart LED Lighting



For further information please visit our website:
www.infineon.com/lighting



Free Webinar!

which are easy for module design and power setting. In addition, the compact sizes of 3030 HV and 5050 HV are suitable for limited space outdoor AC modules, reducing the volume and cost of luminaires in the meantime. Used with an optical lens, The 3030 HV and 5050 HV series are optimized to be applied in any kinds of lighting sources, including street lights, high/low bay, outdoor flood lights and bulbs.

In addition, for residential lighting applications, Edison Opto launches the PLCC 5630 Robin series, which features uniform color mixing, excellent light quality and a wide angle design (150°x125°). With linear IC, 5630 Robin can reduce the volume of luminaires. The small package of 5630 Robin series is especially suitable for thin lamps such as ceiling lights, down lights and bulbs. It is absolutely the best choice for home lighting.

Edison Opto actively develops a variety of high efficiency and low cost components to meet all kinds of customers' lighting demands. Edison's PLCC series is under mass production and can be ordered now. It is expected to be conducive to customers' street light and residential lighting applications. ■

Everlight Electronics Extends Automotive LED Portfolio

Everlight Electronics CO., LTD., a leading player in the global LED and optoelectronics industry with three decades of experience in optoelectronics, introduces the highest efficient/sulfur resistant 'golden' Series, which performs brilliantly, even in severe environments, satisfying all demands of automotive applications.



Highlights of Everlight's extended automotive portfolio are the high-efficient, sulfur resistant golden frame series and PC amber options

Following the trend of high-tech design on automotive applications, Everlight sees only the LEDs with stable performance and high quality can stand out to fulfill customers' expectations. New golden automotive series matches their highest requirements exactly. A golden frame significantly improves a products' quality to resist sulfur. This means it works well, no matter how severe or bad the environment is, including a nearby volcano. The golden series are widely used in head lamps, DRL, fog lamps, side signal lamps and rear tail lamps; over 0.5W products are especially suited for side Signal Lamp (A09K, 67-21 and 67-31). The new versions enhanced with a golden lead frame are named A09KU, 67-21U and 67-31U. Their original counterparts with silver lead frame remain in the portfolio and continue to be offered.

The advantage of PC Amber is an enhanced brightness at high temperatures. Their 3 chip manufacturing process in contrast to the 4 chip process for traditional amber LEDs results in a brightness decay at 85°C of only 15% versus 30-50% for the original amber LEDs. Thus PC Amber LEDs provide a superior thermal and color stability performance. All of EVERLIGHT's automotive LEDs with wattages of 0.5W or more are PC Amber-colored now. Everlight is working with a global team of partners with the meticulous demand for minor defect in quality and establishes a new milestone for the car lighting market.

Everlight is committed to complete set of management system certifications, including TS-16949, OHSAS 18001, ISO 14001 for production quality. All products comply with AEC-Q101 (Automotive Qualification Requirements for Discrete Product) and other highest criteria. With ever increasing demands on LED car lamp applications, Everlight cooperates with major car lamp manufacturers for premium designs that fulfill top LED product demands, winning great trust in the OE market by the public. ■

Lumileds Offers Cost Effective LED for Single-Source Beam Control

Makers of directional lamps now have a more affordable LED option that offers single-source beam control: the Philips Lumileds Luxeon 5258. This multi-die emitter enables

the most cost effective design of PAR 16, PAR 20, MR16 and GU10 lamps using existing drivers at 24V and 96V.



Lumileds' new Luxeon 5258 is a cost effective option for PAR 16, PAR 20, MR16 and GU10 lamps that offers single-source beam control

Key Applications:

- Lamps
 - MR16
 - GU10
- Spotlights
 - Track heads

Features & Benefits:

- 5mm optical source enables good optic design for great punch
- Hot-color targeting ensures color is within ANSI bin at 85°C
- Binned within 3-step and 5-step MacAdam ellipse ensuring color uniformity
- Compatible with low cost and high efficiency drivers
- Available in 24V and 96V options

"We are providing a high flux, high efficacy LED that improves the quality of light and avoids the unfortunate "showerhead effect" that users experience with distributed, multi-die solutions. The Luxeon 5258 can achieve lower system costs compared to solutions using multiple LEDs for 35 W and 50 W MR16 today," said Ahmed Eweida, Product Manager. Lumileds initial offering of the LEDs in the 5258 plastic package is in warm white CCTs with a minimum CRI of 80. The 24 V solutions provide 425 lumens at 110 lm/W, while the 96 V solutions provide 400 lumens at 105 lm/W. However, both can be driven to deliver up to 650 lumens. A 5 mm diameter optical source enables precise beam control in directional applications.

The Luxeon 5258 is designed to provide the best efficacy and flux metrics with superior reliability and droop curve than all competing solutions on the market. ■



▶ Ultra-Thin Hybrid Lens



LL01CR-CEWxxL02

DxH(mm) 50x15
FWHM 12° 24° 38°
Cree CXA13xx
Citizen CLL020
Sharp Mini Zenigata



LL01CR-CFExxL02

DxH(mm) 70x17.5
FWHM 12° 24° 38°
Cree CXA15xx
Citizen CLL020/ CLL030
Sharp Mini/ Mega Zenigata

LL01CR-CENxxL02

DxH(mm) 70x17.5
FWHM 12° 24° 38°
Cree CXA15xx
Citizen CLL020/ CLL030
Sharp Mini/ Mega Zenigata



LL01CR-CEOxxL02

DxH(mm) 90x19.5
FWHM 12° 24° 38°
Cree CXA1820/ 25xx
Citizen CLL030
Sharp Mega Zenigata



Our Services



▶ R & D ▶ Precision Mould ▶ Manufacture
▶ Component solution ▶ Customerization

Further technical information is available, please contact us for more details.

SemiLEDs Announces Phosphor Converted (PC) LED Chip Series

SemiLEDs Corporation, a global provider of vertical LED technology solutions, announced sampling and volume availability of its Phosphor Converted, or PC LED chip series. The series launches with PC amber, PC green and PC red LED chips in a 40 mil (1 mm x 1 mm) chip size. SemiLEDs PC LEDs utilize SemiLEDs' proprietary ReadyWhite™ phosphor technology to minimize blue pass through, thus achieving higher luminous flux, efficiency, and lumen maintenance over time and temperature compared to monochromatic LED chips.

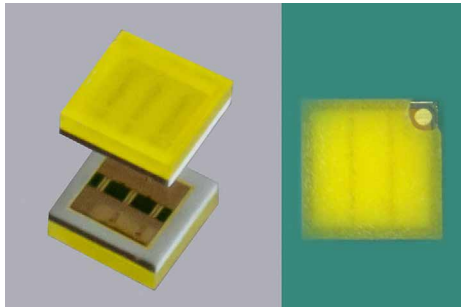

SemiLEDs PC LED chip series is now also available in PC Amber, PC Green and PC Red

PC amber and PC red on InGaN based materials provide better forward voltage matching in RGBA applications gaining efficiency and achieving higher lumen per watts. Greater color stability is also achieved by the use of PC amber and PC red with respect to input currents and changes in junction temperatures.

With increased efficiencies, PC green LED offers a broader spectrum and provides a rich, beautiful color for green color applications. The increased color range can provide significant advantages in applications such as traffic lights, projection and entertainment lighting.

Mark Tuttle, General Manager for SemiLEDs, commented, "With our well established InGaN and ReadyWhite Technology, SemiLEDs' color portfolio is no longer limited to blue, white and UV regions. The new PC amber, PC red, and PC green LED chips will allow more options for our customers in these color ranges."

SemiLEDs' PC series of LED chips are RoHS compliant with production quantities available to order now. ■

BJB Aims for Zhaga Standardization for Their Linear Flat System

The philosophy of "late stage finishing" promoted by BJB promises added value in production, storage, installation and subsequent modification by separating the LED light source and the luminaire body. This is impressively demonstrated by the Linear Flat System from the BJ/OEM-Line.



The Linear Flat lighting module - consisting of light source, lamp holder and lamp support - is designed for Late Stage Finishing, i.e. the LED light source can be clipped into the housing at a later stage. Cap and holder system guarantee easy and safe handling

Instead of adopting the increasingly common solution of fusing LED luminaire body and light source, including control gear, BJB has opted for "late stage finishing" – the classic approach. The Linear Flat System consists of LED light source, lamp holder and lamp support. In this way, a luminaire range can be manufactured as before and the "lamp" integrated at a later stage. The appropriate LED light source in terms of luminous flux, color temperature and color rendering is only fitted to the customer's specification once the order has been placed – i.e. just prior to delivery or final installation of the lighting system. This enables the luminaire manufacturer to cut down on storage of expensive LED components that have the potential to rapidly become obsolete and to reduce high levels of capital commitment.

An alternative possibility for manufacturers with a high degree of vertical integration is to use their own LED light source with a BJB lamp holder and lamp support, thereby enabling them to offer individual system solutions.

With "late stage finishing", the user always receives a luminaire with the latest lighting parameters – which makes sense when dealing with a fast-moving technology in which new LED generations come onto

the market every year. There are also additional benefits during on-site installation as the LED light source can be clipped into the luminaire shortly before the lighting system goes into operation.

By keeping the luminaire body separate, it is also possible to replace the LED light source later, for example, if rooms are put to new use. A new, brighter generation of LED or one with a different color temperature can then be used. The Linear Flat System provides the same flexibility as that offered by conventional luminaires and the tool-free method of installation means convenient handling and ease of maintenance.

These comprehensive benefits are proving effective: The Zhaga Consortium's "SFS, Socketable Flat System" task force is studying the Linear Flat System with a view to standardizing it in its own Book.

The impressive features of the Linear Flat System are its extremely compact design, its clean lines and its excellent lighting parameters. This innovative product is therefore predestined for use in luminaires or strip lighting systems that were previously the domain of T5 fluorescent lamps.

The light source, which is actually only 37 mm wide, consists of an extruded aluminum profile with LED module and a diffusing PMMA cover. As it is fully enclosed no special ESD measures are required by the luminaire manufacturer. This simplifies the production process significantly.

The holder element is designed to compensate for thermally induced expansion that occurs when the module is in operation.

The connector provides the electrical contact and fixing of the lighting element, which simply swings into position. When the end marked with the logo is pressed, the element locks into place with an audible and palpable click. It can be released by pressing again and initially remains hanging in the connector to prevent it from accidentally falling out.

With a length of 580 mm or 1168 mm and an overall height of only 13 mm, the Linear Flat System is suitable for a variety of applications. The short versions with 3,000 K and 4,000 K color temperature achieve 1,160 lm and 1,203 lm of luminous flux. With twice the number of LED light points,

NEW CREE® XLAMP® LEDs CAN:

IMPROVE RELIABILITY ::

REDUCE SYSTEM COST ::

REDEFINE LED LIGHTING ::

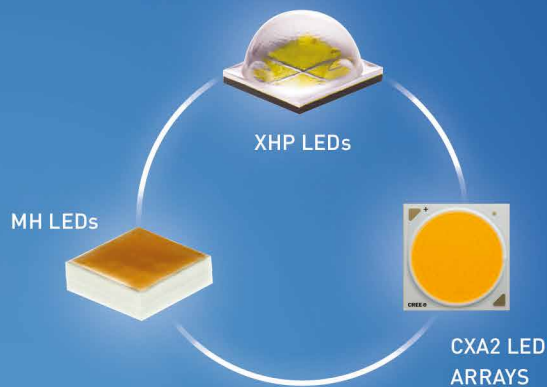

GAME CHANGING IS GREAT. BOTTOM LINE CHANGING IS BETTER.

You can't change your bottom line by using the same LEDs that everyone else is using. Cree's Extreme High Power (XHP) LEDs deliver double the lumen output at high operating temperatures, while our MH LEDs combine the system advantages of our best arrays with the manufacturing ease of a discrete. And our CXA2 LED arrays are packed with lumens to offer system cost savings up to 60%.

CREE 

See how higher power equals lower cost.
cree.com/xhp

The new way to a better LED array.
cree.com/mh

Even more lumens for savings up to 60%.
cree.com/cxa2

luminous flux outputs are 2,036 lm and 2,105 lm. The long version achieves almost double these luminous flux values with a module efficiency of up to 128 lm/W at a color temperature of 4,000 K.

With these characteristics – which reflect the philosophy of “late stage finishing” – the Linear Flat System from the BJB / OEM-Line represents an intelligent solution offering considerable added value to both luminaire manufacturers and end-users. ■

Smart AC LED Module 12 W - Operating Directly from 230 VAC

FuturoLighting, a company focused on LED lighting solutions, introduces a smart AC LED module operating directly from 230 VAC network. Module integrates AC driver with high PFC above 0,97 offering ON/OFF and dimming functionality with stand-by consumption below 0,5 W. The module was designed in several versions covering basic, triac dimmable, analogue dimmable and smart functionality.

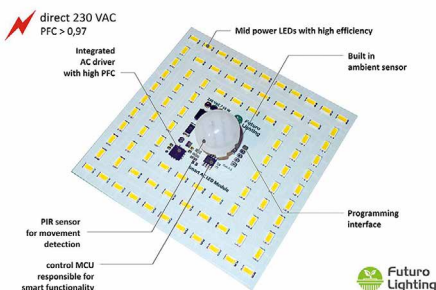

FuturoLighting's smart AC LED module can be directly powered by the 230VAC mains

Dimensions of the module are 100 x 100 mm with height of 5 mm for basic and 25 mm for smart version. It is first integrated approach of an AC driver together with movement sensor and smart behavior. Practically these modules are electrically behaving as real incandescent bulb (resistive load). Smart version offers corridor functionality with adjustable delay time, where stand-by level can be adjusted from 0 to 80% through programming interface directly on the module. Specialty of this solution is integrated dimming behavior that makes light change during switching ON and OFF of the module visual smooth. Smart module has implemented ambient sensor for recognition of day/night and its threshold level can be easily adjusted through programming interface as well.

Smart AC LED module can be populated from various LED brands. Current design accepts Osram Duris E5, Samsung LM561, LiteON 5630, LG and other similar footprint mid power LEDs. It must be noticed that used AC conversion principle is not flicker free and is mostly suitable for cost sensitive applications where Class I is acceptable. This module can be customized according to customer requirements. Design files of the AC LED module as well as measurement reports are available for sale in design package. In case of interest, feel free to contact us. ■

More Design and Less Installation with TALEXEngine DC String

As miniaturized light sources, LEDs offer great design freedom to luminaire manufacturers. So far, LED drivers that are essential and need a lot more space than the light sources themselves have placed restrictions on the design. With the TALEXEngine DC String, Tridonic is now offering an LED solution that makes AC/DC converters and DC/DC components go their separate ways, creating space for new design ideas.



Tridonic's new DC String LED is the heart of the Zumtobel Supersystem – a modular, multifunctional LED lighting system

Tridonic has reached a milestone in lighting design with its DC String LED solution. The system supports the trend towards the

miniaturization of LED luminaires, increasing freedom of design and making installation easier at the same time.

In present LED lighting solutions, each LED light source needs an LED driver that contains an AC/DC converter and a DC/DC component. The AC/DC converter takes up most space in the LED driver, defining the component's minimum size at the same time. This structure is therefore an obstacle to further miniaturizing LED luminaires and to increasing freedom of design even more.

In the DC String LED solution, the AC/DC converter, which takes up a lot of space, is separated from the conventional LED driver and is installed at a higher-ranking central location, from where it can supply LED light sources with a total output of up to 150 W in an energy-efficient way. If installed downstream, the lighting system works as a low-voltage DC LED system. The individual light sources, or luminaires, are now only equipped with a low-profile, compact DC/DC module, or the module has already been integrated into the light source, eliminating the limitations that AC/DC converters have created so far. Luminaire manufacturers have the opportunity of further miniaturizing LED luminaires and developing even smaller lighting solutions, which blend discreetly into the room and offer impressive high system efficiency.

DALI and emergency lighting components will also be centrally connected to the AC/DC converter, eliminating the need for connecting them to the individual LED light sources. DALI dimming commands are converted to digital power line signals for the DC/DC modules by the DALI converter. The system still remains DALI-compliant, with each light source appearing separately as a standalone address, and working in an identical way. That way the lighting system only requires one DALI converter, and emergency lighting components can now also be upgraded from a central location without any additional wiring. The central system gives architects and lighting designers more flexibility for placing luminaires in a room in an aesthetic way, meeting specific demands. Installers benefit from easy installation at reduced cost, with maintenance decreasing too.

Upgrading existing lighting systems is equally simple, for example, upgrading a non-dimmable lighting system to a dimmable

lighting solution. It's enough to replace the existing light sources with light sources that have a DC/DC module, and to connect a higher-ranking central AC/DC converter, as well as DALI and emergency lighting components, if required.

Zumtobel's Supersystem – a modular, multifunctional LED lighting system offering new angles for lighting design and for the flexibility of placing luminaires in a room – provides insight into the potential of the new DC String LED lighting solution. ■

Seoul Semiconductor Introduces New Modules Based on Acrich3 Technology

Seoul Semiconductor, a leader in LED technology announced the availability of new Acrich3 modules for a wide range of residential and commercial lighting applications. The new advanced Acrich3 solution from Seoul Semiconductor enables the next generation of Smart-Lighting systems with the ability to interface through a wide variety of wireless networks and sensors.

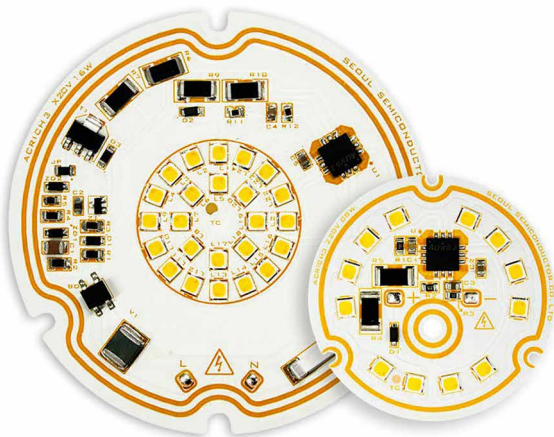

With the ability to power IR sensors and Bluetooth controllers, the new advanced Acrich3 IC enables easy integration for your Smart-Lighting electronics

Main Features:

- Introduction of new Acrich3 modules for a wide variety of general lighting applications
- Acrich3 Technology - Ability to interface with existing Smart lighting protocols
- Acrich3 technology with enhanced compatibility with existing TRIAC dimmers

This technology does not require a complex AC/DC converter and can be operated directly from the AC mains, which simplifies designs, reduces component count and improves on the reliability of the luminaire. It also incorporates an analog dimming input as well and an increased compatibility with existing TRIAC dimmers with the ability to do uniform dimming giving lighting designers an easy to implement advanced lighting solution.

The new Acrich3 modules being released incorporate Seoul Semiconductor's proven and reliable high voltage LED architecture with Acrich MJT series of LEDs. These modules are available in

EPISTAR



Actualize LED Potential

- Co-activation Service Model
- Full Spectrum LED Chips Portfolio
- Chip Solution for Various Applications

2015 Guangzhou International Lighting Exhibition

June 9 - 12, 2015
Hall 10.2 Stand B19
China Import and Export Fair Complex,
Guangzhou, China

EPISTAR Corporation
5 Li-hsin 5th Road, Hsinchu Science Park,
Hsinchu 300, Taiwan
T: +886 3-567-8000 F: +886 3-579-0801
sales@epistar.com.tw www.epistar.com



Website Facebook

different lumen outputs and form factors to address a wide range of lighting applications from downlights to street and area lighting. Available in 2700 K - 6500 K with CRI options of 70, 80 and 90 these modules offer typical efficiencies of up to 100 lm/W with low THD and high power factor.

Kibum Nam, Vice President of Product Development said, "The new Acrich3 modules from Seoul Semiconductor offer a complete solution for smart lighting systems with the Acrich3 IC and MJT LEDs. First launched in 2005 the Acrich technology has provided innovative solutions worldwide to a wide range of applications in the commercial, residential and industrial lighting environments. In the future, Seoul Semiconductor plans introduce more products to further enhance the adoption of the Acrich technology." ■

LeDiamond Announces Continuous Double Side Emitting LED Module

LeDiamond Opto Corp, a leading double side emitting LED manufacturer from Taiwan, has announced its new revolution in Tesla 4003 2in1 module. The Tesla 4003 2in1 (Dimension: 80 mm x 16 mm x 0.80 mm - L x B x H) is a double-side emitting LED module, which is suitable for lighting fixtures that need direct and indirect light output, such as office pendant or wall lamps.

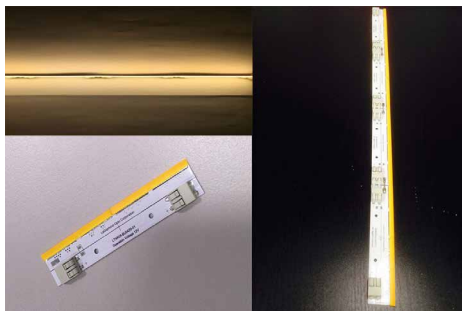

LeDiamond introduces a new linear continuous double side emitting LED module

Tesla 4003 2in1 can be applied to design ultra-thin double side emitting lighting fixtures due to its uninterrupted light emitting area with quick assembly and reliable performance.

There is no dark area between the LEDs; hence it allows the reduction of the distance between LED module and diffuser. Using Tesla 4003 2in1 in ultra-thin lighting

fixtures eliminates the weakness of spots that occur in traditional PLCC modules.

The light output of each module is 500 lm at 12 V with 350 mA. The image shows an example using 4 pieces of 4003 modules with WAGO connectors to extend the module length, which leads to an overall light output of 2000 lm. ■

American Bright Opto Introduces Complete, Innovative AC LED Family

American Bright has introduced a complete family of direct AC LED modules that allow for rapid product development and standards compliance while dramatically reducing bill of materials cost for the most common industry applications. The next generation of AC compatible LED solutions eliminates the need for costly external AC to DC conversion. The second generation GoldenEye® family of light engines employs American Bright's patented SimpleDrive® technology that eliminates the need for capacitors, resistors and advanced magnetics while allowing users to connect modules directly to 120 VAC, US mains, line voltages.

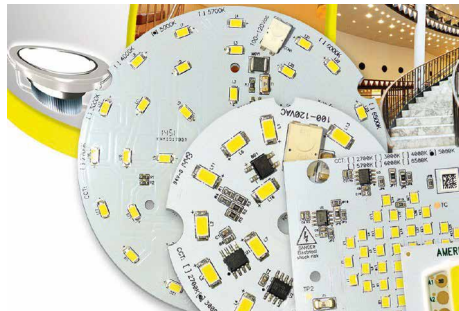

American Bright Optoelectronics' new family of direct AC LED modules is especially designed to perfectly support the US mains line voltage of 120 VAC

The complete family provides dedicated, application specific solutions, for both the commercial and residential lighting industries. Modules in both round and linear form factors are available in lumen packages ranging from a low of 300 lumens for task and accent lighting to a high of over 3000 lumens for traditional down lighting applications. Linear modules are capable of producing over 1000 lumens per foot replacing most existing light sources typically available to today's designers. Both form factors (round and linear) are available in

Zhaga compliant interfaces for fixture manufactures that have already designed around this standard for easy retrofit or replacement of existing light engine modules.

Third party independent testing (LM80) confirms the new family of light engines will exceed the minimum life and stability requirements set forth by both Energy Star and the Design Lights Consortium (DLC) while maintaining Title 24 compliance with 90 CRI and full range dimming capabilities.

The family of AC light engines is readily available in standards compliant ANSI color bins from warm white (2700K CCT) to bright white (5000 K CCT) color temperatures. A high CRI of greater than 90 is available in all lighting class color temperatures. The inherent efficiency of an AC-direct design allows for a high power factor greater than 0.9 with no additional power conditioning or power factor correction circuitry required. An additional benefit of the AC SimpleDrive configuration is the full range dimmability. Compatibility with many Lutron and Leviton dimmers has been confirmed through independent testing. The simple plug and play nature of the American Bright solution reduces development time, assembly costs and still maintains the robust and reliable features of a solid-state lighting product.

"We have built on the success of our original GoldenEye LED products and now have a module solution for just about every lighting application," George Lee, President of American Bright Optoelectronics Corp., noted. "The direct AC nature of our modules allows for a simple, cost effective means of producing LED versions of the most commonly used fixtures," Lee added. "The low solutions cost and reliability of our modules removes any remaining barriers to LED conversions for most fixture manufacturers," he concluded. ■

Cooledge Lighting Square - an Advanced Light Sheet Version

Cooledge Lighting, the leading developer of flat and flexible LED lighting solutions, has expanded its "light sheet" portfolio with Square, a one foot by one foot, UL Listed lighting product that requires no heat-sink, can be snapped together to create a larger lit plane and can be trimmed to size, even while

TAILOR-MADE FOR COB LED_s

LOW COST RCOB LED DRIVERS —
DESIGNED TO DRIVE HIGH POWER LED_s

- TAILOR-MADE FOR YOUR LED

DIMMABLE OR CC OUTPUT

PRESET CURRENTS FROM 350mA TO 1050mA IN 50mA STEPS

OUTPUT VOLTAGE RANGE FROM 6V TO 44VDC

- EASY TO INSTALL

SINGLE-SIDE CONNECTION

PRACTICAL SQUARE SHAPE

- FULLY PROTECTED

(OLP, SCP, OCP, OTP)

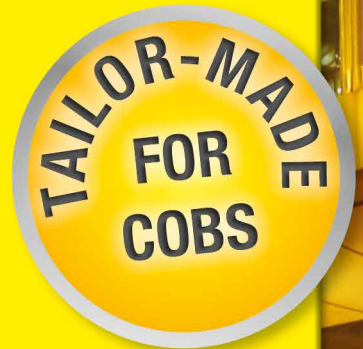

www.recom-lighting.com

RECOM
LIGHTING

powered. The unique light source can be affixed to almost any surface and provides uniform, smooth illumination in a range of color temperatures. It's equally efficient in wide area lighting applications including general illumination and backlighting and can be used in curved, convex and concave architectural elements in a simpler, more efficient way than is possible with bulbs and tubes.



The handling of Cooledge Lighting's Square is claimed to be „plug and play“ simple

Square is a complete lighting product that can be sized for virtually any installation in three ways:

- Multiple Square can be snapped together to expand the area that will be lit
- Square is flexible and can be wrapped around a column or curved surface
- Square can be trimmed to length with a pair of scissors, even while lit

“Part of our vision for lighting is to keep implementation ‘kindergarten simple’” said David Kriebel, vice president of sales and marketing for Cooledge. “The Edison screw base and two-pin fluorescent solutions have made installing a bulb easy but did nothing to change the shape or possibilities of how lighting is applied. Square is so ‘plug and play’ simple that a child could snap it together.”

Regardless of installation method, Square can be as close as two-inches to a diffuser material (cloth, onyx, plastic, etc.) and provide a smooth, uniform appearance without spots, stripes or color variation.

Together with Light Sheet, the company is redefining what is required to form a luminaire and freeing architects and lighting designers from bulb and tube form factors. Installations at the New Coach store on Central Park West and the TopShop flagship store on 5th

Avenue in New York City are great examples of how these new form factors can be used to create beautifully lit effects. ■

Synchronous Step-Down LED Driver Delivers up to 40 A

Linear Technology announces the LT3744, a synchronous step-down DC/DC converter designed to deliver constant current to drive high current LEDs. Its 3.3 V to 36 V input voltage range makes it ideal for a wide variety of applications, including industrial, DLP projection and architectural lighting. The LT3744 uses two external switching MOSFETs, delivering up to 20 A (80 W) of continuous LED current from a nominal 12 V input. In pulsed LED applications, it can deliver up to 40 A of LED current or 160 watts from a 12 V input. Delivering efficiencies as high as 95%, it can eliminate the need for external heat sinking.

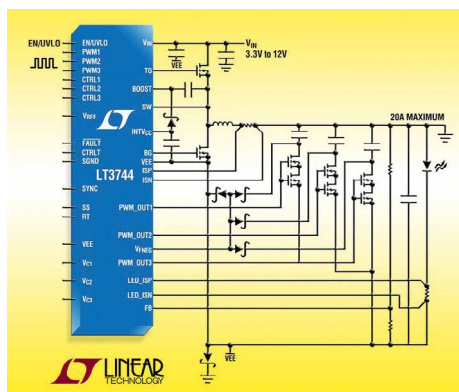

Schematics of a high current synchronous step-down LED driver with 4-state control

Features:

- Drives up to 40 A LEDs with a single stage
- Up to 3,000:1 PWM dimming
- 20:1 analog dimming
- $\pm 3\%$ Current Regulation Accuracy
- $\pm 3\%$ Voltage Regulation Accuracy
- Unique inverting step-down topology allows single common anode heat sink to be used for RGB LEDs
- 3.3 V to 36 V input voltage range
- Peak current mode with DC LED current sensing
- Open & shorted LED protection & fault reporting
- Floating LED driver allows single power solution to drive multicolor LEDs or single LED with three different regulated currents
- Thermally enhanced 5 mm x 6 mm QFN 36-lead package

The LT3744's peak current mode controller maintains $\pm 3\%$ LED current regulation over a wide voltage range from V_{EE} to V_{IN} . By allowing V_{EE} to float to negative voltages, several LEDs can be driven from a single Li-Ion battery with a simple, single step-down output stage. Additionally, this enables a unique inverting step-down topology that allows a single common anode heat sink to be used for RGB LEDs. A frequency adjust pin allows the user to program the frequency between 100 kHz and 1 MHz, optimizing efficiency while minimizing external component size. Combined with its QFN package, the LT3744 offers a very compact 80-watt LED driver solution.

The LT3744 provides both PWM dimming and CTRL dimming, which offer 3,000:1 dimming capability for four LED current levels, ideal for color mixing applications, such as those required in DLP projectors. Similarly, its unique topology enables it to transition between two regulated LED currents in less than 2 μ sec, enabling more accurate color mixing in RGB applications. LED current accuracy of $\pm 3\%$ is maintained to offer the most accurate brightness of light emitted from the LED. Additional features include output voltage regulation and open-LED and shorted-LED protection, open-drain output fault flag, frequency synchronization and thermal shutdown.

The LT3744 is available in 36-pin 5 x 6 mm QFN package. Two temperature grades are available, with operation from -40°C to 125°C (junction) for the extended and industrial grades. ■

First NFC-Commissioned Smart Home & Lighting Solution from NXP

NXP Semiconductors has announced the launch of its new best-in-class, low power and long range JN5169 wireless microcontroller and accompanying smart home and smart lighting solutions, featuring certified ZigBee LightLink, Home Automation, GreenPower software stacks and, the first in the market, a NFC-commissioning option that allows users to connect systems intuitively with just one tap. An on-chip +10dBm power amplifier within JN5169 doubles the connectivity range of NXP's existing smart home products.

Expert of High Power LED Luminaries



- At the same Wattage, **SHINYU is brighter** (Lux/W BIG)
- At the same Lux, **SHINYU saves more** (\$/Lux CHEAP)
- At the same Usage, **SHINYU can last longer** (6Khr, 0% decay)

Change your mind toward to innovation

- Most mature COB and thermal technology.
- Designed heat sink with efficiency thermal convection hole, no over heat problem.
- 6000 hours 0% luminance decay.
- Interchangeable lens, luminous efficiency increased by 30%.
- No double shadows. High uniformity.

www.shinyu.com.tw +886-3-563-0589

Street Light



Spot Light



Flood Light / RGB Light



Light Engine



High Pole Light



E40 Bell Light



Outdoor Waterproof FPC

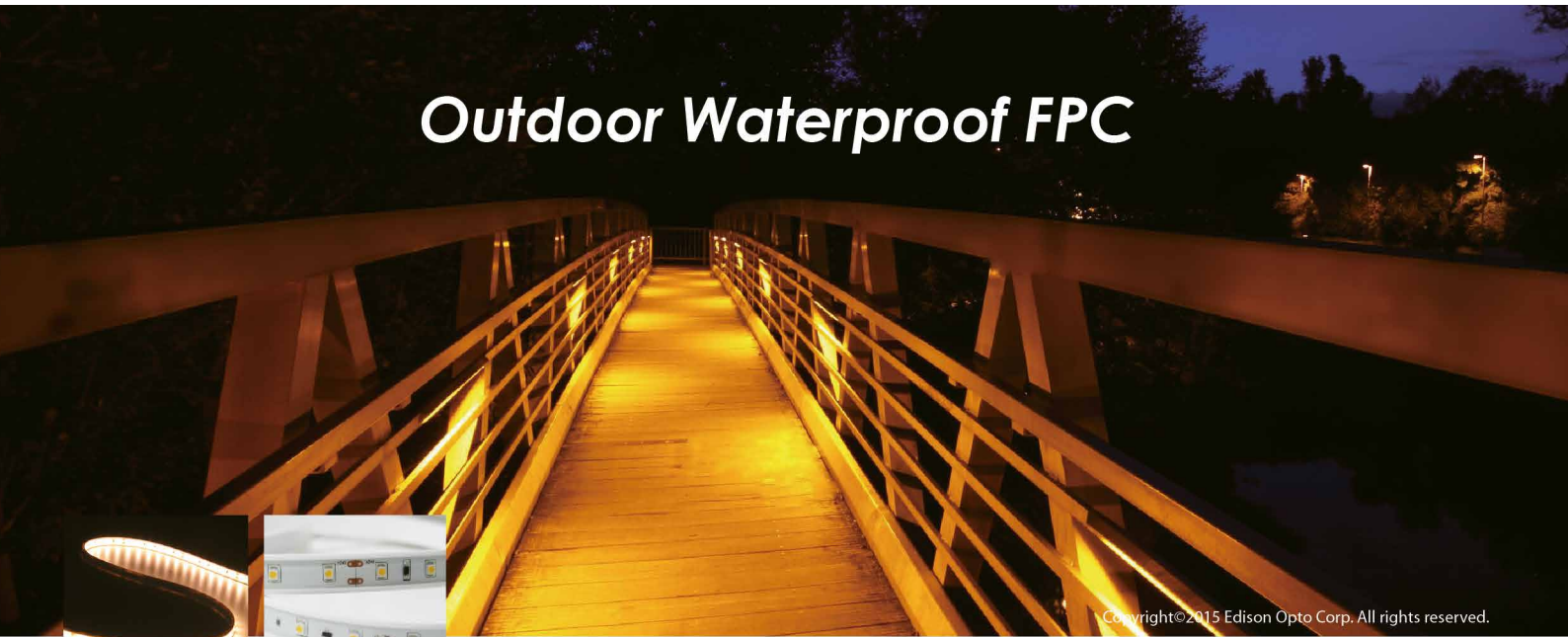

Copyright©2015 Edison Opto Corp. All rights reserved.



Features :

- Flexible
- High Brightness
- Waterproof IP67
- Long Life
- UV and Corrosion Resistant

Applications :

- Outdoor Walkway
- Staircase Accent Lighting
- Cabinet Lighting

Emitting Color	LED Package	LEDs Quantity (M)	Power (W/M)	Flux (lm/M)	Input Voltage (V)
Cool White	3528	120	9.6	610~710	24
Neutral White	3528	60	4.8	195~245	24
Warm White	5050	60	14.4	585~700	24



guangzhou international lighting exhibition

June 9-12, 2015
China Import and Export Fair Complex
Hall 10.2 Booth A19

Visit us



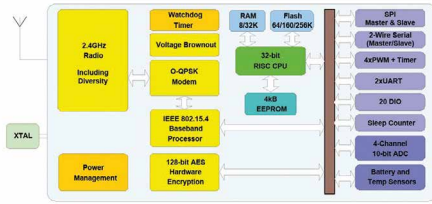

Basic block diagram of NXP's current NJ516x product line

The solution features the ability to connect with 250 nodes allowing for it to be deployed in a wide range of uses in homes and industrial environments. ZigBee 3.0 and Thread ready, JN5169 also features a new tool chain for software development that allows up to 15% code size reductions and features extensive debugging capabilities. Intuitive one-touch commissioning using NFC connectivity ensures that the devices can be easily yet securely paired without sending network details 'over-the-air', thus strongly reducing the threat of hacking.

To support JN5169, NXP is launching three new design references for white, tunable white and RGB(W) color lamps, which reduce the total build cost of smart lighting solutions up to 25%. With 512 kB embedded flash memory, there is enough memory available on the product to enable Over-The-Air software upgrades, meaning that expensive external flash memory is no longer required, leading to additional cost savings. The lamp reference designs are complemented by wireless switches, remotes, wall panels, sensors, smart plugs and gateways as well as control by cloud services from NXP and its eco-system partners.

"Home automation is one of the leading sectors of the IoT market. As these devices come ever more prominently into the mainstream, our customers need lower cost, easier to use, more robust and more secure solutions," said Jacob van der Pol, business development manager RF Connectivity Solutions, NXP.

"What we have announced in response to this is an all-encompassing solution for the smart lighting and home automation market, which will outstrip other competitors in convenience, reliability and cost. JN5169 demonstrates that we are not only at the forefront of the smart lighting and home automation industry, but also the leading innovators."

Other key features of JN5169 include:

- 14 mA receive current allowing to reduce the standby power of bulbs down to an ultralow 100 mW
- Only 20 mA transmit current at +10 dBm which is at least 40% lower than other products in the market thus maximizing battery life of wireless nodes
- The use of low cost 85°C crystals for smart bulbs instead of more expensive 125°C specified crystals enabled by innovative circuit and software techniques

Leading players in the smart lighting market, including TCP INC. and Leedarson, are already adopting the new JN5169 product.

David Geraci, product manager connected lighting at TCP Inc., Aurora, USA said: "NXP is our long-term valued partner for connected lighting products. With NXP's new JN5169 wireless microcontroller based reference designs, TCP will be able to improve both the performance and ease of use of our connected lighting products and thus maintain our leadership in the US connected lighting market".

Joe Zhou, strategic marketing manager at Leedarson, Xiamen, China said: "Leedarson has been developing smart bulbs starting from NXP reference designs since 2011. The unique features of the new NXP JN5169 ZigBee chip allow Leedarson to improve range and efficiency and lower standby power consumption of our smart lighting product portfolio and thus to offer a more attractive and green solution to our customers." ■

ISSI Expands FxLED Driver to drive 144 LEDs

Integrated Silicon Solution, Inc., a leader in advanced memory and analog IC solutions, announced its high performance matrix LED driver for use in automotive, consumer, industrial and emerging IoT applications. The IS31FL3732 is a compact LED driver for RGB color-effect with pre-programmed lighting and animation functions. These pre-programmed functions are accessed via a fast 1MHz I²C compatible interface with robust EMI performance, which reduces microcontroller demand, enhances performance and improves battery life.



ISSI's new IS31FL3732 is a matrix LED driver that can be cascaded

The IS31FL3732 supports two arrays of 72 LEDs, for a total of 144 LEDs, which can be individually dimmed in 256 steps (8-bit) with 1/9 cycle rate. The signals to drive all 144 LEDs are multiplexed to a reduced count of 18 that requires fewer traces and optimizes PCB space. The IS31FL3732 integrates 8 frames of memory, which can be displayed with programmable time delays to create LED matrix animations. For an extra dimension of animation, analog inputs such as audio signals can be used to modulate the LED display intensity.

The IS31FL3732 also allows multiple ICs to be synchronized without additional external components for applications such as Bluetooth speakers, Internet gaming peripheral devices, white good appliances, toys and personal electronics.

The ISSI FxLED driver can multiplex up to 16 devices in a cascade arrangement delivering unique lighting effects. The IS31FL3732 offers the highest performance in its class and is capable of driving up to 2304 LEDs for a range of applications.

The IS31FL3732 matrix LED driver is available in a small QFN-40 (5 x 5 mm) package. The device's operating voltage of 2.7 V to 5.5 V over the industrial temperature range of -40°C to +85°C offers individual blink, on/off control, 256 step global current control, and auto intensity breathing during the switching of different frames. ■

Fulham's New Products from LIGHTFAIR® International 2015

Following the new corporate Identity that reflects a new era of innovation & product intelligence to maximize performance and lower costs, Fulham, Co. Inc. announced that they will be introducing a new line of

We bring quality to light.



DISCOVERING
LIGHT

Putting LEDs in the right light.

SSL solutions from the world leader in LED measurement



LGS 1000
Goniophotometer
with new features

Right from the start, we have been supporting the LED industries with our measurement equipment. You will also benefit from this expertise in the new Solid-State Lighting applications. Our solutions combine highly precise spectroradiometers and photometers with a complete family of goniometers and integrating spheres. Discover light with Instrument Systems.

www.instrumentsystems.com/ssl

 **Instrument
Systems**
light measurement



BEYOND NORTH AMERICA

- Obtain energy efficiency, performance, safety certifications and more
- Access global markets
- Leverage industry expertise and standards development
- Verify the quality of your lighting products

DISCOVER MORE AT UL.COM/WEKNOWLIGHTING



DALI and 0-10V programmable LED drivers and a new LED driver / emergency battery pack combo product at LIGHTFAIR® International.



Fulham's new ThoroLED driver series can be programmed with a unique hand-held programmer, while the new HotSpot™ "All-In-One" LED Driver / Emergency Battery Pack is an easy-to-install solution

New ThoroLED™ Programmable LED Drivers are offered with a unique hand-held programmer that can set different current outputs for the drivers being used in luminaires – right on the production line bench – either stand-alone or connected to a computer. The new drivers provide for bill-of-material and stocking simplification, lower cost and streamlined inventories to OEM lighting fixture manufacturers.

The new HotSpot™ "All-In-One" LED Driver / Emergency Battery Pack provides an easy-to-install solution for LED luminaire manufacturers that need stand-by battery back-up in case of power interruption while lowering the total installed cost, by simplifying installation and wiring. Fully compatible components ensure complete interoperability and that luminaires will have the highest quality and performance. The product is backed by Fulham's 5-year warranty.

"Fulham has entered a new era of innovation and design, and these new products reflect that progression for the company," stated Bob Howard-Anderson, President and CEO of Fulham. "Adding programmability, addressability and controllability is part of our overall strategy to bring more intelligence to our LED drivers, modules and engines, as well as to our new, industry-leading LED emergency lighting products and solutions. Further, our updated corporate identity reflects the forward-looking approach we are taking to innovative product development and solving customers' needs. ■"

Universal Lighting Technologies - New Compact, Linear Everline® Drivers

Universal Lighting Technologies has added to its already extensive line of well over 1,000 LED products, with the launch of two new Class 2 UNV and 347V Everline® LED Driver Families with tunable constant power output -- Compact Drivers and Linear Drivers. The two new driver families are available with a variety of output current and power options that provide even more design flexibility for LED lighting.



Everline LED Class 2 Compact Drivers are available for different current and power ratings

"The tunable constant power output of our latest Everline Compact Drivers allows us to provide customers with greater flexibility for applications for a wide variety of modules," said Greg Bennorth, LED product manager for Universal Lighting. "Thanks to their multi-lead terminal configuration, our compact drivers are ideal for downlight and specialty applications requiring compact style driver housing. Our linear drivers, with their 1-inch-high, low profile housing, are perfect for use in general lighting applications."

Universal's tunable constant power output allows the driver's current to be tuned down while increasing the output voltage up to a maximum of 56 V, enabling output power capacity to remain constant over a wide range. This permits the drivers to offer excellent load regulation with low total harmonic distortion (THD) and a high power factor (PF), down to 40 percent of the maximum output of power loading. Both new drivers incorporate dimming with 0-10 V controls.

The new Everline LED Class 2 Linear Drivers are available in 700 mA and 1050 mA current with a maximum output of 30 W, 1050 mA and 1500 mA current with a maximum output of 55 W and 2100 mA current with a maximum output of 80 W.

The new Everline LED Class 2 Compact Drivers are available in 700 mA and 1050 mA current with a maximum output of 30 W as well as 1050 mA and 1500 mA current with a maximum output of 55 W. The drivers in this family additionally feature a multi-exit lead terminal, allowing for both side-exit and bottom-exit configurations. Bottom exit configurations are available with studs for J-Box mounting. ■

C3 Lighting Solutions Develops a Breakthrough Networked LED Lighting Management Solution

C3 Lighting Solutions, Inc. develops a breakthrough technology that changes the way LED lighting is powered and controlled. The new technology has made what was once impossible, possible. C3 Lighting Solutions' networked system places the power, dimming control, scheduling and energy management of LED lighting in a single, centrally located device separate from the LED fixtures.



C3 Lighting Solutions' new concept is based on a centrally located device separate from the LED fixtures that provides power, control, and energy management

C3's products have captured the attention of the lighting industry by reducing the complexity, size, weight and cost of LED fixtures, power supplies and controls, in addition to eliminating the need for metal conduit and large gauge wiring in most lighting installations. This technology allows the wiring for lighting to be similar to what is typically used for in-wall speaker systems, greatly reducing installation costs and providing a substantial reduction in a buildings' carbon footprint.

"Remotely locating and combining the power, control, and energy management of an entire LED lighting system in one device provides countless advantages over current LED and fluorescent lighting that require AC power to be run to a ballast or LED driver in each fixture," said Rick Farrell, President of C3 Lighting Solutions, Inc. Microprocessor control, on-board memory and a clock calendar allow dimming of any light or room in a building, scheduling when a

Lextar

Lextar Electronics

Comprehensive Linear Application

Meets all kinds of segment for linear lighting



See more



3014 160 lm/W

- Achieving 160 lm/W with 75% size reduction
- LM-80 certified 50,000+ hrs
- Uniform light

5630 200 lm/W

- High efficacy for premium appliances
- LM-80 certified 50,000+ hrs
- Highest quality and one form factor with various lumen options



20th Onwards
Inspire & Be Inspired
9-12 June 2015

guangzhou international
lighting exhibition

Hall 10.2 Booth C19

Lextar.com

Sales.LT@Lextar.com

From Lighting to Electronics...



Specialty Chemicals for Your Complete Lighting Assembly
Adhesives | Sealants | Potting Material | Thermal Management



Ask the Glue Doctor®
1.800.888.0698
ellsworth.com

Products from
DOW CORNING
Henkel
FISNAR
The Art of Chemistry

light will be on or off, changing the color of light output, programming “dawn-to-dusk” illumination indoors, and monitoring energy usage. This technology can power and control up to 50 kW of DC power and interfaces with most wired or wireless industry standard lighting control systems and will also accept DMX commands.

C3's remote power technology can switch between AC, solar, wind, hydrogen cell, or battery stored power and can also supply DC power for office or personal electronic devices. This allows the system to function as a building's “DC Micro-grid”. It can serve as the communication backbone for a Building Management System without incurring the expense of the additional wiring typically required. C3's technology makes lighting a managed resource and the investment even more compelling with its substantial reduction in environmental impact. ■

Tridonic - TALEXXdriver Premium

The Premium TALEXXdriver series has been designed to keep pace with rapid developments in LED technology and offers an extremely high degree of flexibility. It features the new digital “ready2mains” interface that uses the existing mains cable for data transfer. Different casing versions and output classes with application-optimized operating ranges make the LED Drivers ideal for a wide range of professional LED solutions.



Tridonic's new Premium TALEXXdriver series can communicate via the familiar one4all interface or via the digital ready2mains communications interface

The first products in the Premium series are linear low-profile devices:

- LCA 50 W 100-400 mA one4all Ip PRE
- LCA 75 W 100-400 mA one4all Ip PRE
- LCA 100 W 250-700 mA one4all Ip PRE

Luminaire manufacturers, electrical contractors and potential users all benefit from the features of this new LED Driver series. TALEXXdrivers in the Premium series can adapt to different lighting requirements with a high degree of flexibility either via the familiar one4all interface or via the digital ready2mains communications interface. This new interface enables digital data, such as configuration parameters, to be transferred directly by means of the mains cable. Upgrading an existing non-dimmable luminaire installation to the latest dimmable LED generation is made easier with ready2mains as there is no need for any new cabling in the ceiling.

Thanks to ready2mains it is now easy to configure control gear with manually settable output current and integrate it in existing test equipment. The advantages over the old method of setting the current manually are obvious. Data transfer is rapid and much less susceptible to error because no manual operations are required at all. Simple integration in automated workflows results in huge potential cost savings in the production of LED luminaires. Nevertheless, TALEXXdrivers in the Premium series can still be programmed via the DALI interface and manual resistance plugs can still be used.

A choice of compact casing designs – C, SR and SC – means that the most appropriate can be used for each type of luminaire. This is of great benefit, particularly in shop applications where space is often tight. Linear low-profile (lp) designs are ideal efficiency-based office applications. Thanks to their dynamic operating ranges they cover the entire output spectrum with maximum efficiency.

The one4all interface continues to be available and adds DALI, DSI, switchDIM and corridorFUNCTION functionality. Other features include a significant increase in efficiency, low standby losses and reduced dimensions. ■

Code Mercenaries Releases DALI Bus Power Supply

LED-Warrior11 by Code Mercenaries is a low cost option to supply power to a DALI bus. Only a 24 V DC supply is required for LED-Warrior11 to generate the current limited bus power for a DALI system. In many LED installations 24 V DC is already available. Versions for mounting on a DIN rail or as a flat PCB module are available.

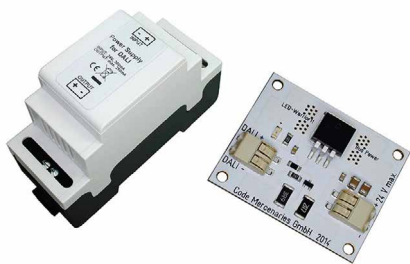

Code Mercenaries' LED-Warrior11 intends to be a cost effective DALI bus power supply

Technical Data:

- DALI bus power supply
- 24 V \pm 10% DC input, 300 mA
- Output: typ. 17 V, current limited at typ. 230 mA, max. 250 mA
- LED for bus power indication and bus traffic indication
- Size (DIN rail module LW11-DR): 36 x 90 x 58 mm
- Size (PCB module LW11-MOD): 47 x 38 x 6.5 mm

LED-Warrior11 provides DALI bus power at a fraction of the cost of common DALI power supplies. ■

Nector M Power System - Connecting Various Lighting and Power Requirements

TE Connectivity, a world leader in connectivity, announces its newly enhanced Nector M power system. In addition to meeting IEC 61535 standards, the power system solution is designed to meet the UL 1977 guidelines and just debuted a 5-position splitter that provides power, signal and control connections options for multiple lighting and electrical devices.

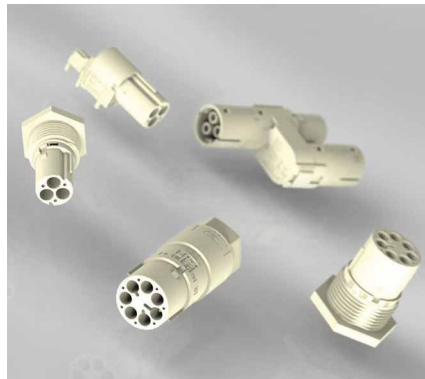

The Nector M power system provides power, signal and control connections meeting the UL 1977 guidelines

TE's Nector M power system solution is a fully pluggable, modular wiring conNector and cabling system for lighting and permanent indoor electrical installations in the construction industry. It's round design drastically reduced installation time especially compared to rectangular conNector systems in nearly any indoor installation. The enhanced systems allow electrical contract manufacturers the ability to engineer, design and build power distribution units, electrical devices and cable assemblies off-site that result in reduced on-site labor costs, increased efficiency and improved reliability for permanent electrical installations.

The state-of-the-art multi-pole, keyed, modular wiring system is ideal for lighting designers, contractors and OEMs that require more flexibility in distributing power to various lighting systems and other common electrical devices within buildings. The availability of junction boxes and splitters makes it easy to configure the system during installation but also to reconfigure the system during refurbishment or upgrade the lighting fixtures. The multiple branch circuit capability simplifies cabling in the premises and its circular form factor simplifies routing during installation when compared with the rectangular electrical connection systems in the market.

The Nector M power system offers various lighting luminaire design options. The 3 Pole power systems are ideal for use in ceiling, wall, pendant, and furniture lighting fixtures that require a ground connection in residential or commercial retail spaces. The multi-phase, 5 Pole

Round heatsinks for lighting industry

- Combined lathe-milling machine for the production of conical heatsink profiles
- Thermal analysis of customer-specified cooling concepts
- Individual mechanical treatments adapted to your application



For more details please check our website:
www.fischerelektronik.de

Fischer Elektronik GmbH & Co. KG

Nottebohmstraße 28
D-58511 Lüdenscheid
Phone +49 (0) 23 51 43 5-0
Fax +49 (0) 23 51 4 57 54
E-mail info@fischerelektronik.de



We exhibit:
LED professional
Symposium + Expo in Bregenz
22.-24.09.2015
stand A16



UE Electronic
Since 1989

24W indoor LED driver
(UE24WZ1-A1Z)
3-24V DC 0.1-3A
TUV(LED EN61347), CE

PSB BSMI SABS WEEE ISO 14001:2004
ISO 9001:2008 CEC OHSAS 18001:2007

CB CCC CQC UL US SPS US FC
CE JET TLC GS

Fuhua Electronic Co., Ltd
Fuhua Electronic Industrial Park, Xianglong Rd.,
Huangzhou New Town, Shilong, Dongguan,
Guangdong, China
Tel: (86) 769-8602 2222 Fax: (86) 769-8602 3333
www.fuhua-cn.com E-mail: fuhua@fuhua-cn.com

power systems provide the power and signal connections required in horticultural and lighting control applications. The multi-phase, 7 Pole systems provide additional power and signal connections for use in emergency lighting systems and for color control lighting capability.

The power system conNectors have operating temperatures between minus 40 degrees Celsius and up to 70 degrees Celsius and provide an IP20 seal rating. The conNectors are available with an IEC 61535 rating of 7 A up to 20 A at 400 VAC and a UL 1977 rating of 10 A up to 20 A at 600 VAC making the conNectors suitable for use almost anywhere in the world.

Nector M power system conNectors have closed barrel pin and socket crimped wire termination terminals. The conNectors are available in white and UV resistant black with multiple keying options available to provide error-free assembly. ■

TE Adds 28 x 28 mm CoBs to the Lumawise LED Holder Series

TE Connectivity (TE), a world leader in connectivity, introduced a new addition to its innovative line of Lumawise LED holders. The high-performance Z50 28 x 28 LED holder enables the electrical, thermal, mechanical and optical connectivity of COB LEDs in a fixture with a solderless connection. The LED holder provides quick and easy solderless connection to support various LED brands on one platform.



TE's Lumawise LED 28x28 mm CoB LEDs solderless holder enables faster assembly and mass adoption of CoB technology

Product Features:

- Achieve a longer operating life with LED snap-in feature & high thermal downward pressure by stainless steel spring
- Save space for optics and mounting with a complete flat top surface with halogen free plastic body with countersunk screws supporting
- Support large recognized platform of more than 11 LED types of size 28 x 28mm
- Save time with a quick and easy solderless connection for faster assembly
- Ensure reliable performance with stainless steel springs for high thermal downward pressure
- Expand the flexibility with enhanced thermal performance that enables working with a variety of thermal interface materials

Lumawise LED holders can be used in a variety of lighting applications:

- Architectural
- Commercial
- Industrial
- Residential
- Retail
- Outdoor
- Emergency
- Off-grid lighting

TE's Lumawise LED holders can accelerate time to market for luminaire manufacturers, allow for minimized applied costs, facilitate easy integration and improve assembly efficiency. The holders are built with RoHS compliant materials, can operate in temperatures from minus 40°C up to 105°C, and can withstand voltages up to 277 VDC/AC. The holder housings can accommodate 18 AWG to 20 AWG wiring and are available in gold and tin contact platings. The LED holders can be used in a variety of applications including agricultural, commercial, industrial, residential, retail, outdoor, emergency and off-grid lighting. ■

New Connectors for LED Applications with White Insulator

New LED technology-based lighting concepts increasingly call for new connectors using an almost white insulator. The normally black insulators absorb a certain amount of light by their very nature. This can lead to a lighting design where a shadow effect may emerge in the connector area.

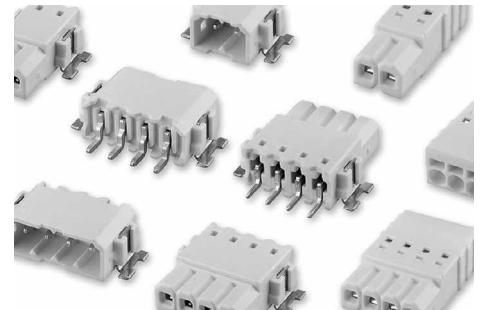

While most standard connectors are black or grey, for LED lighting modules white connectors are advantageous for avoiding shadow effects

Fischer Elektronik is now addressing this problem with a new connector series for LED inline modules by offering 2.5 mm grid male and female headers in SMD soldering versions. These headers are available in two- and four-pole variants, with further pole counts upon request. In addition, the product range features matching mains connectors for supplying the LED system with power by means of a cable connection. These rigid or flexible cables can be in a size of AWG 24-20.

The connectors are delivered in a "tape and reel" (TR) packing to enable efficient assembly. The cases have a robust and form-fitting design. ■

AVX Introduces the Lowest Profile Poke-Home Connector

AVX Corporation, a leading manufacturer of passive components and interconnect solutions, has introduced the lowest profile poke-home connector currently available on the market.

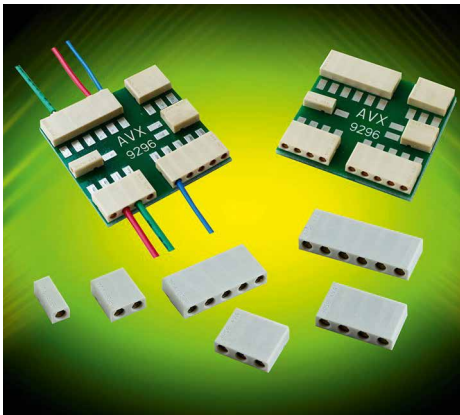

AVX's new 9296 Series horizontal connector provides maximum mechanical stability & wire retention in a sleek SMT package

Featuring its industry-proven 2 mm dual beam, high spring-force, phosphor bronze poke-home contacts in a sleek 3.0 mm pitch by 2.5 mm high SMT package, the new horizontal 9296 Series connector is certified to UL 1977 and CAN/CSA C22.2 specifications, and accepts any combination of 20–26 AWG solid or stranded wires, providing quick, reliable, and cost effective wire-to-board termination in a broad range of harsh industrial, commercial applications.

Rated for 300 V, up to 8 A, and operating temperatures spanning -40°C to $+130^{\circ}\text{C}$, the new low-profile 9296 Series poke-home connectors, available in 1–6 positions, meet harsh industrial performance standards and provide maximum mechanical stability and wire retention despite enabling simple strip-and-insert electrical connections and twist-and-pull wire extraction. Specific applications for which the series is ideally suited include: machine controls, such as motors, drives, solenoids, sensors, fans, and pumps; commercial building controls and security and fire sensors; medical

equipment and sensors; smart grid meters, breakers, and panels; and SSL/LED bulbs, fixtures, signage, and streetlights.

“The new, low-profile 9296 Series horizontal SMT connector provides a robust wire-to-board solution that’s ideally suited for an extremely broad range of applications, since nearly every product on the market has at least a small number of discrete wires connecting components to a PCB” said Tom Anderson, product manager at AVX.

Smaller and more functional than the only directly competing connector on the market - featuring a 2.5 mm vs. 2.7 mm height and 1-6 positions vs. 1-3, accepting 20-26 AWG solid or stranded wire vs. 22-26 AWG solid, and offering current and voltage ratings up to 8 A vs. 3 A - the RoHS-compliant 9296 Series horizontal SMT poke home connector features a mechanical durability of three cycles and is supplied on tape and reel for single contact automated placement and SMT reflow. Lead-time for the series is stock to nine weeks. ■

EVERFINE

Make every customer more satisfied

Quality LED & Lighting Measurement Instrument

EVERFINE is the only public company focusing on LED & lighting measurement instrument worldwide. EVERFINE provides all kinds of LED & lighting test and measurement solutions for laboratories, production lines and lighting fields with quality products and professional service.



More  www.everfine.net

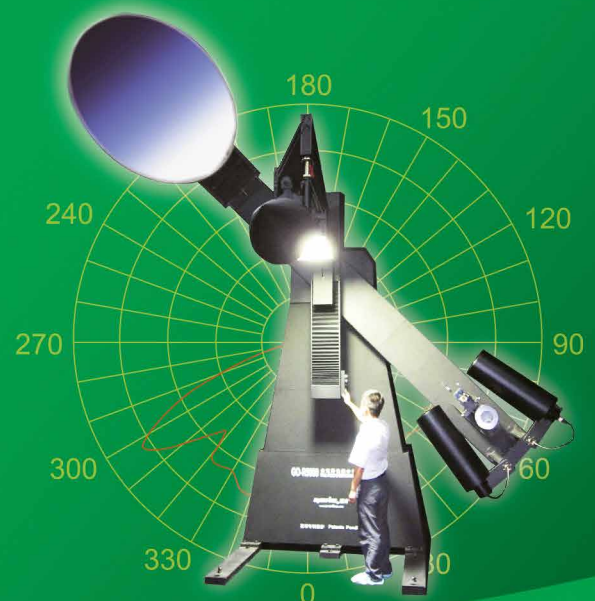

New GL Spectis 1.0 Touch Version Now Measures PAR & PPF

The GL Spectis 1.0 touch by GL Optic is an intuitively operated spectral measurement instrument with touchscreen for mobile light measurement. Offering the accurate determination of photometric and radiometric values, such as the color rendering index (CRI), correlated color temperature (CCT), color coordinates, radiant power or luminous flux, the instrument provides data significant in quality control or research processes. The device originally developed for lighting designers or luminaire and LED manufacturers has now been optimized for the measurement of radiation relevant during plant growth.

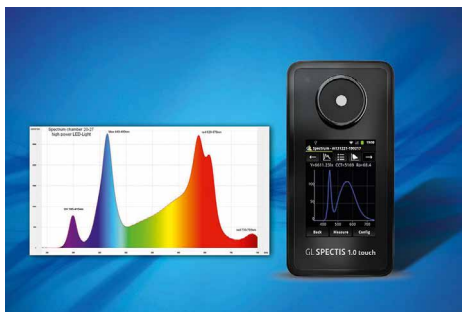

GL Optic's GL Spectis 1.0 touch PAR/PPFD smart spectrometer also measures photon flux density relevant in plant growth applications

Sunlight spans over a large spectral range, with wavelengths of 290 to around 3000 nm, thus from UV to near infrared. The visible range for human eyes, as well as the radiation which is also used by plants for photosynthesis, is between 380 and 720 nm. This photosynthetically active radiation (PAR), made up of photons, constitutes about 40-50 percent of the emanated solar energy. At the same time, short-wave light such as blue is higher in energy than long-wave red light. In accordance with the chemical processes of photosynthesis, photons work effectively regardless of their energy content. Because of this, surplus energy is, for example, emitted to the leaves in the form of heat. Therefore, to determine plant growth it is necessary to measure the light quantity as photosynthetic photon flux density (PPFD), rather than the energy value of the absorbed radiation.

In addition to PAR, expressed in W/m^2 , the specially developed GL Spectis 1.0 touch PAR/PPFD thus precisely measures PPFD values, expressed in $\mu mol/m^2/s$, through the weighting of appearing wavelengths at varying magnitudes. Thus short-waved or

more energy-rich wavelengths like blue are weighted at an appropriately lower magnitude than long-wave radiation. For scientists and biologists, values that can be measured using the GL Spectis 1.0 touch PAR/PPFD are of vital importance for the cultivation of plants and the research of plant growth. Even today, this light measurement instrument by GL Optic has already been implemented in a NASA project which is researching the cultivation of plants in outer space.

Measurements can be made using the small 74 x 124 x 26 mm instrument without a PC and saved on the supplied microSD card. The Android-based GL Spectis 1.0 touch features Wi-Fi connectivity and USB 2.0 for data transfer. For use in test setups, the measurement instrument features a screw adapter for installation on a tripod. Moreover, GL Optic offers an extensive range of accessories that includes integrating spheres, laboratory-grade software, as well as additional measuring instruments and individual solution concepts. ■

Seren Photonics - Next Gen of Semi-Polar GaN on Sapphire Templates

Seren Photonics announced the launch of its latest generation of 11-22 GaN templates that continues to be based on Seren's patented approach developed by Professor Tao Wang's team at the University of Sheffield. The improved performance comes about through a manufacturing upgrade that not only improves crystal quality, but also enhances manufacturing yield.



According to research results, using semi-polar GaN has the ability to reduce droop in blue LEDs

This approach has already completed qualification for 2" diameter product and as part of its development activity; Seren has now adapted the enhanced approach to the

development of 4" and 6" templates. "With demand for 4" and 6" accounting for over 75% of the sapphire market for LEDs, the need to provide customers with industry standard 4" diameter wafers along with the option to upgrade to 6" makes total commercial sense" said Bedwyr Humphreys Chief Development Officer at Seren Photonics. 4" templates for customer sampling are expected during Q3 2015, with 6" planned to come in H1 2016.

Experts in the semi-polar GaN field will know that semi-polar GaN displays anisotropic behavior under x-ray diffraction. What this means is that, unlike c-plane GaN, semi-polar GaN crystal quality is dependent on the direction along the wafer that the measurement is taken. This latest development has overcome this issue yielding a semi-polar GaN layer with isotropic crystal quality. This not only enhances the optical isotropy of the material but also ensures electrical properties such as mobility are also isotropic.

This latest generation is now available for sampling in 2" diameter or custom sizes. At less than 5 μm thick, the GaN layer for these semi-polar templates is the thinnest available on the market today, ensuring minimal wafer bow with maximum defect blocking. ■

Soraa's New PAR20 LED Lamp for Perfect Lighting Design

Soraa, the world leader in GaN on GaN™ LED technology, announced that it has added to its full visible spectrum LED product portfolio a PAR20 lamp with incredibly high CBCP, flawless beam definition and edges, and outstanding color and whiteness rendering, ideal for both commercial and residential applications.



Many lighting designers prefer PAR20 lamps for their installations because they are the perfect size



瑞豐光電

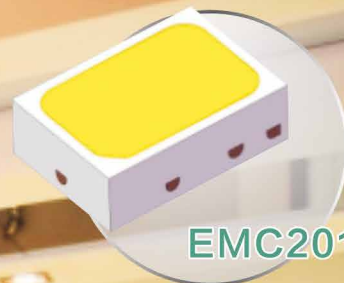

EMC2014



EMC3030

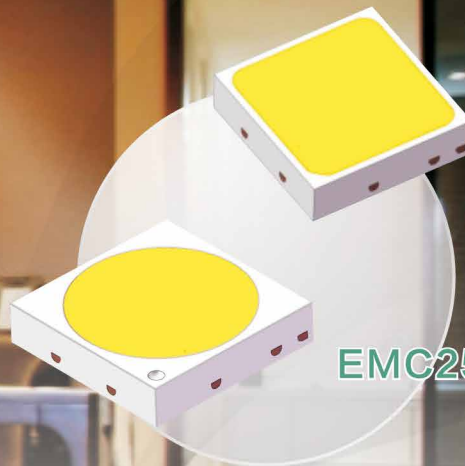

EMC2525

Features

- MacAdam Ellipse, keeping color consistency
- EMC with high temperature resistance and reliability, yellowing resistance
- QFN EMC packaging type, ultra-thin, ultra-small and user-friendly design
- Pass the LM-80 test

Application

Fluorescent tube, bulb, candle light, ceiling light, grille light, down light, panel light, side light LED, high-efficiency tubes

Stock Code : 300241.SZ
www.refond.com

绿色光源 造福人类 减负地球
Green Lighting Benefit human Lighten the earth

深圳市瑞豐光電子股份有限公司
SHENZHEN REFOND OPTOELECTRONICS CO.,LTD.

ADD : Building #1, 10th Industrial Zone, Tian Liao Community,
Gong Ming Area, Guang Ming New District, SHENZHEN, CHINA

TEL: +86-755-66839118 FAX: +86-755-66839300



The PAR20 features the company's Point Source Optics™ and Violet-Emission 3-Phosphor (VP₃) Color™ and VP₃ White™ technologies providing a superior replacement for 75 W to 90 W legacy products.

Neither too big nor small, the PAR20 is perfect in every way," explained George Stringer, Senior VP of America Sales and Marketing at Soraa. "Powered by the world's most efficient LED, the PAR20 provides unmatched color quality with our VP₃ technology and superior optics with our Point Source Optics technology, while still delivering 85% energy-efficiency over standard halogen lamps."

Soraa's Point Source Optics technology enables the offering of the industry's only 10-degree narrow spot version of a PAR20 LED lamp while delivering a Center Beam Candle Power (CBCP) almost double that of its nearest competitor. The optics seamlessly produce beautiful, high intensity and uniform beams and are available in four beam angles including 10, 25, 36 and 60 degrees.

With a color-rendering index (CRI) of 95 and deep red (R9) rendering of 95, the 10.8 W PAR20 not only crushes its halogen counterparts, but easily outperforms its LED competition as well.

The company's Violet-Emission 3-Phosphor (VP₃) LED technology allows for perfect rendering of colors and whiteness. Utilizing every color in the rainbow, especially deep red emission, Soraa's VP₃ Vivid Color renders warm tones beautifully and accurately. And unlike blue-based white LEDs without any violet/ultra-violet emission, the company's VP₃ Natural White is achieved by engineering the violet emission to properly excite fluorescing brightening agents including natural objects like human eyes and teeth, as well as manufactured white materials such as clothing, paper and cosmetics.



Honglitronic Offers the Best Efficacy of SMD 2835

SMD LED 2835, one package with various lumen options from 0.1 W - to 2 W, PPA-PCT-EMC product portfolio. High light efficacy, up to 170lm/W (@60mA), low thermal resistance (19°C/W), Applications: Tube lights, panel lights, down lights, bulbs. 700 million PCS per month production capacity, IESNA LM-80 certified.

Competitive cost, the best efficacy, the best choice!

For more information, please visit en.honglitronic.com



sales@honglitronic.com



Putting LEDs in the Right Light

SSL solutions from the world leader in LED measurement.

- **Spectroradiometers**
Unprecedented photometric and colorimetric accuracy
- **Goniophotometers**
Three models for different sample sizes
- **Integrating Spheres**
Ranging from 25 cm to 2 m in diameter
- **Imaging Photometers and Colorimeters**
Homogeneity of extended sources and OLEDs



www.instrumentsystems.com



Cree's LMH2+ Delivers an Unprecedented Combination of 125 lpw Efficacy and 90 CRI in a Small Form Factor

Cree's LMH2+, the industry's highest performing LED module, delivers 30% better performance than the previous generation in the same form factor. Providing efficacy of 125 lumens per watt with color quality greater than 90 CRI, the LMH2+ is the only LED module that allows lighting manufacturers to achieve a system efficacy of 100 lumens-per-watt with high light quality. The efficacy of the LMH2+ drives new applications, enables smaller luminaires and lowers system cost.



cree.com/lmh2plus



LED Plastic Bulb Cover

The bulb cover from Bicom Optics, of which the diameter is 44.6 mm and the height is 33.8 mm, is transparent and the LED light can reach more than 90% with the focusing effect. It can break through the original angle of the light source. In addition to the outstanding optical performance and reliability designed for this product, ease of assembly is also optimized.

This kind of bulb cover can be used widely for many LED bulbs.

Please visit www.bicomoptics.com to learn more.



Soraa's PAR20 LED lamps are offered in 75 W (Soraa Vivid) and 90 W (Soraa Brilliant) equivalents, and a 50 W replacement option will also soon be available. The lamps are available in four color temperatures ranging from very warm white to cool (2700 K, 3000 K, 4000 K and 5000 K), and Soraa is the only lamp manufacturer that guarantees lamp-to-lamp color consistency to be within a 3-Step MacAdam Ellipse for its PAR20 products.

The PAR20 Series is compatible with enclosed fixtures and suitable for damp operating environments. Additionally, all of Soraa's PAR20 10 degree LED lamps are designed to work with the company's award-winning magnetic accessory Snap System. With a simple magnetic accessory attachment, beam shapes can be altered and color temperature can be modified, allowing endless design and display possibilities. ■

Cree Offers New Light Experience with Its Cutting-Edge WaveMax Technology LED Optical Platform

Cree, Inc. ushers in a new era of LED lighting with the introduction of Cree WaveMax™ Technology, an optical breakthrough that enables next generation light experiences. Challenging the possibilities of today's lighting, the waveguide platform features a revolutionary combination of control, uniformity and efficiency to deliver a superior visual experience in new form factors that are intelligent in both design and function – achieved only through Cree® LED technology.



Cree's new WaveMax™ technology based LN Series promises exceptional efficacy, high quality lighting and a sleek, architectural design

"Cree is surpassing assumed boundaries of LED technology, driving breakthroughs that fundamentally transform the way light is experienced," said Norbert Hiller, Cree executive vice president, lighting. "With WaveMax™ Technology, we are delivering our most intelligent light yet, enabling the future of highly-efficient, modern building designs to become today's reality, while accelerating adoption of better LED lighting at greater value."



3D LED Optics, 2m length

Precise optics offer an efficient realization of custom-designed light distributions. VS offers unique manufacturing capabilities for 3D optics with up to 2 meters in length.

Precise light distribution

Individual freedom of design

Flexible, 3D optical structures

Featuring Cree DiamondFacet™ optical elements to achieve up to 90 percent optical efficiency and precise optical control, Cree WaveMax Technology can deliver unmatched visual comfort, uniform illumination and improved color quality while enabling unprecedented design capabilities and energy-saving potential for modern LED luminaires. As a result, high CRI (Color Rendering Index) lighting and warmer color temperatures can be achieved without sacrificing efficacy and enhancing the ability to achieve USGBC LEED® certification.

The first interior LED luminaire to feature WaveMax Technology, the Cree® LN Series suspended ambient luminaire combines precise indirect/direct optical control and exceptional efficacy in a sleek, architectural suspended luminaire for both new and existing commercial building spaces. Featuring a modular design to simplify installation and improve design freedom with increased spacing between luminaires, the highly efficient LN Series luminaire enables quiet ceilings for vibrant spaces, at a price aimed to drive adoption. When paired with Cree's intuitive SmartCast® Technology wireless controls, occupants experience intelligent light at an affordable price, creating a customizable lighting environment that can save more than 70 percent in energy costs over outdated linear fluorescent lighting.

Bringing technology-driven design aesthetics to renew the more than four million parking garage luminaires installed in the U.S., Cree also unveils the Cree® IG Series LED parking garage luminaire. Featuring WaveMax Technology for streamlined design and efficacy, the IG Series transforms the look of parking garages with superior low-glare

illumination. The highly efficient luminaires can deliver more than 80 percent energy savings and quick payback of less than two years with 24 hour-a-day usage compared to outdated metal halide lighting. Programmable motion controls further increase these savings and enable a simple way to customize settings for high or low occupancy applications.

"Cree continues to prove that long-lasting LED technology can do infinitely more than save energy and maintenance costs – it's the smarter choice for our bottom line, tenants and buyers experience," said Steve Maranos, vice president of technology, CMC Group, Inc. "With Cree's IG Series luminaire, we're rethinking what lighting can do. It is unlike any solution on the market - delivering the modern design, controllability and low-glare illumination with performance that exceeds our expectations for any parking application, all while delivering significant ongoing savings at an affordable price." ■

Meteor Lighting Debuts Whiz Bidirectional High Bay LED Luminaire

Meteor Lighting has a new addition to the popular Whiz Series, the Whiz Bidirectional. It is one of the first LED high bay luminaire to deliver upward and downward lighting control for simultaneous illumination of ceiling and floor in 150 W and 250 W. Majority of LED fixtures on the market cannot deliver both up and down light, which in turn could obscure a grand ceiling, becoming an issue for architects and lighting designers. To rectify this problem, Meteor developed Whiz Bidirectional to expand LED applications into uncharted territory.



Meteor Lighting's Whiz Bidirectional high bay LED luminaire offers upward and downward light control

Meteor Lighting has transplanted the efficient Whiz module into a newly designed housing for a clean contemporary look. The concealed heatsink features streamlined structural design with nano-radiation heat dissipation coating to deliver optimized thermal management for increased efficiency. The driver can be installed remotely with distance up to 200' for easy maintenance.

Despite its compact size, the Whiz Bidirectional is still capable of delivering 25,000 lumens, with 100 lm/w energy efficiency. The 2 fins on the side of the fixture deliver 15-20% upward lumens at approximately 4500 lm. The fins can be adjusted manually. Whiz Bidirectional comes standard with 0-10 V dimming. The dimming capabilities for the upward and downward light can be controlled together or separately, which increases the functionality of the space as one can create different scenes for different events in each project.

Whiz Bidirectional is especially suited for spaces where definition of ceiling structure is needed. Application ranges from sports halls, convention centers and auditoriums, and manufacturing facilities to airports. ■

WEBINARS

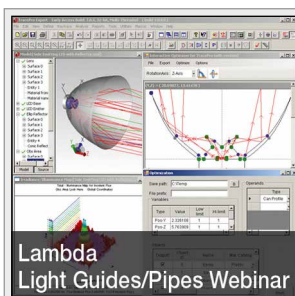

Designing & Optimizing Light Guides/Pipes - Tips & Tricks for a Streamlined Process

The Light Guide Design and Optimization webinar will teach viewers how to enhance the efficiency and output uniformity of their design. Viewers will learn how to take advantage of Total Internal Reflection, when to use diffusers and resins, and how to use photorealistic rendering to see exact light pipe output before moving to the costly prototyping stage. There will also be a full demo of how to use 3D CAD software to virtually prototype light pipes to avoid a trial-and-error design process.

www.led-professional.com/Lambda-Webinar



Fraunhofer FEP Presented Transparent Color Tunable OLED

The project LOIGB (LED and OLED integration into glass and plastic composites for the use in lighting systems for railway and further applications) has been successfully completed. The results were presented at LOPEC 2015 (March 4th – 5th, 2015, Munich, hall B0, booth 230).

The objective of the joint project was the development and integration of large-area color variable OLED modules, whereby the light colors red, green and blue (RGB), which are required for the achievement of white mixed light, can be controlled separately. Thus it is possible to generate any desired color, including white, with one and the same OLED module. The realization of large-area 3-color-variable OLED modules could be demonstrated in the project.

The OLED modules have a diameter of 55 mm with an active light area of 42 mm. They were encapsulated with a full thin film, which enables the lamination of OLED modules in glass composites.

For the first time worldwide a transparent 2-color variable OLED, which can show a color gradient from blue to white to yellow, was demonstrated. This exhibit was presented to the visitors of LOPEC 2015 at the Fraunhofer FEP booth. A possible field of application could be its use as the light source in a laminated glass sheet that serves



The color tunable OLED modules have a diameter of 55 mm with an active light area of 42 mm

as baggage compartment in trains. The company SBF Spezialleuchten GmbH, the coordinator of the project, is working on such solutions.

“The possibilities for application of the results, which are achieved within the project, are extraordinarily versatile”, says project manager Jan Hesse. “In addition to the use in general lighting, e.g. in windows, wall elements or wallpapers, the color variable OLEDs are also suitable for the interior vehicle lighting - especially for the ambient or accent lighting - in the automotive and rail vehicle industry.”

In addition, the aviation industry shows great interest in using this technology for ambient lighting within an aircraft cabin.

The results that were achieved in the project LOIGB provide a basis for further activities at Fraunhofer FEP. Currently, the scientists are working on the process development in order to achieve higher yield and reduce manufacturing costs as well as to realize the process transfer to a roll-to-roll system for flexible OLED. Moreover, the intuitive control of such lighting elements will become a priority. Compared to conventional light sources, the complex functionality (dimmiability, color variation and dynamization) requires new intuitive control possibilities. A simple control is absolutely necessary in order to achieve market acceptance for that innovative lighting technology.

The project was funded by the European Union and the Free State of Saxony. ■

LED PAR LAMP RANGE

The perfect replacement of traditional halogen Par lamps, emitting the same amount of candela power while only consuming 12% of the energy.

Available in shape of Par16/20/30s/39L/38, narrow flood and wide flood, CCT 2700-6500K, Color Rendering Index of 80/90/95 optional.

Accurate optical design for best performing beam control.

High quality surface finishing and artistic shape, wet location rated design, suitable for shops, exhibitions, hotels, restaurant and so on.

UL and ENERGY STAR® certified.

DANGOO



PAR 16



PAR 20



PAR 30s



PAR 30L



PAR 38

Dangoo Electronics
 www.dangoo.com.cn | info@dangoo.com.cn | Tel: +86 (21) 5426 4988 | Fax: +86 (21) 5426 4977
 Global Offices: Asia | USA | Europe



LpS 2015 - Trends and Technologies for Future Lighting Solutions

Artificial lighting greatly contributes to global energy demand and human well-being. Smart designs and controls are crucial for further developments of solid-state lighting technologies. The 5th LED professional Symposium +Expo (LpS 2015) covers the entire lighting value chain, from electronic components to lighting systems. The LpS provides a platform to determine future trends and find solutions to current challenges in LED and OLED lighting system design. LpS 2015 will focus on the “building blocks for smart lighting designs”.

With over 60 lectures on core SSL topics, interactive workshops, panel discussions and a premium exhibition, the symposium and expo will address smart systems, new standards, advanced functionalities and new user behaviors.

The event will open on 22nd September with keynote speeches by Prof. Zary Segall - Endowed Chair Professor at The Royal Institute of Technology (KTH) in Stockholm, Mr. Rogier Van der Heide - Chief Design and Marketing Officer, Zumtobel group and Mr. Jy Bhardwaj - Senior Vice President R&D, Lumileds. Prof. Segall will discuss “Semantic and Connected Lighting” explaining how Human Centric Lighting and Internet of Things drive these trends. Mr. van der Heide will discuss the “State-of-the-Art in Smart Controls, Internet of Things and Human Centric Lighting” providing a holistic perspective, also introducing important design trends and aspects. Mr. Bhardwaj, will highlight “Trends and Challenges for System Integration” discussing cost, reliability, miniaturization and thermal management and analyzing their impact on the luminaire system.

The technical lectures will highlight trends and visions in SSL and cover the topics of reliability and lifetime, lighting systems and light sources, smart controls, drivers and sensors, thermal management, optics and measurement. Presentations on “Concepts of Intelligent Lighting, Taking into Account Color Quality and Human Centric Lighting” presented by Prof. Tran Quoc Khanh from TU Darmstadt, “Sky Luminance and Radiance Distribution Patterns” presented by Prof. Ardeshtir Mahdavi from TUWien and “Potential Health Issues of SSL” presented by Prof. George Zissis from the Université Paul Sabatier - Toulouse III will contribute to an overall holistic approach towards SSL technologies. Additionally, trends in OLED manufacturing presented by Yole,



The LpS 2015 exhibition area has had to be extended to accommodate even more top manufacturers

“Smart Designs for Human Centric Lighting” presented by Mr. Peter Dehoff, Zumtobel and “Smart Controls for Lighting” presented by Dr. Walter Werner will showcase new trends and directions. The LED professional Scientific Award will honor the best scientific paper submitted by a university or research institute.

Participants will be further inspired to create new designs and transform innovations to the next level with hands-on workshops. The topic of Automotive Lighting will be addressed in a workshop organized by the European Photonics Industry Consortium (EPIC), bringing together key stakeholders from the automotive industry. OLED lighting and niche applications will be presented in an interactive workshop by LG Chem, the global leader in OLED technology, with hands-on demonstrations of the latest panels and designs. A third workshop on “Smart Controls Innovation” will be presented by Luger Research that will delve into the evolution of smart controls and apply innovation methodologies to systematically forecast next generation products.

A key highlight of the first day is the “Design meets Technology” program especially for lighting designers, architects and planners. With the large scale uptake of solid state lighting, a closer collaboration and dialogue between engineers and technicians as well as lighting designers, planners and architects is essential to drive innovations,

effect fundamental changes and generate demand for new technologies. This audience will learn how the latest lighting technologies work and the requirements for different applications. Further, they will experience how lighting control should work under various conditions.

They will be guided on a “Design meets Technology” tour through the Expo, where they will be shown state-of-the-art technologies across the lighting value chain, from the light source up to system integration, with demonstrations and latest products showcased by leading global companies. The program continues with a design demonstration and award organized by Seoul Semiconductor and the University of Applied Science, Munich. Seventeen design students will have participated in a four-month university project called “Out of Bounds – Design Contest”.

The premium exhibition will include the top 7 global LED manufacturers: Cree, Everlight, Lumileds, Nichia, Osram, Samsung and Seoul Semiconductor who will use the LpS as a platform to showcase their latest technologies.

With a comprehensive technical program and exhibition, the LpS 2015 promises to be a key enabler for the trends and technologies that will drive the future of solid-state lighting solutions. ■

LpS 2015

LED SYMPOSIUM
professional +EXPO

EARLY BIRD REGISTRATION

Register by June 30th and
SAVE UP TO 160 EUR!

www.lps2015.com/registration

5TH LED professional Symposium +Expo

Trends & Technologies for Future Lighting Solutions

SEPT 22ND- 24TH 2015 | BREGENZ | AUSTRIA

Trends and Visions | Lighting Systems | Smart Controls | Light Sources
Thermal Management | Optics & Measurement | Reliability & Lifetime

- Keynotes from Zumtobel & Lumileds
- OLED Workshop, LG Chem
- Automotive Lighting Workshop, EPIC
- Smart Controls Innovation Workshop, Luger Research
- Luminary Design Demonstration and Award, SSC and University of Applied Science Munich
- Scientific Award
- Premium Expo with Top 7 Global LED Manufacturers
- Design meets Technology Day for Designers & Architects

www.lps2015.com

Organized by Luger Research e.U.



TRIDONIC
enlightening your ideas

auer
LIGHTING

OSRAM
Opto Semiconductors

zumtobel group

ZUMTOBEL

THORN
LIGHTING PEOPLETRIDONIC
enlightening your ideas

Light is essential to all life and is vital to humankind in all of life's situations. To underscore the enormous importance of light for people as well as for the sciences, business and the arts, the UN has proclaimed 2015 as the International Year of Light and Light-based Technologies (IYL 2015). Being the 65 year anniversary of the company, for the Zumtobel Group, the IYL 2015 represents an important year of strategic realignment. With the mission of blazing new trails and showing people what light can do above and beyond its familiar applications, the company's goals go hand in hand with the central ideas behind the IYL.

A GLOBAL PLAYER IN LIGHTING CELEBRATES THE IYL

by Arno Grabher-Meyer, LED professional

From April 8 to 10, the Zumtobel Group invited journalists, clients and friends to celebrate the IYL 2015 with them. For over 50 invited journalists, the event started with a press dinner where they could discuss the latest news and rumors in the lighting branch and ask questions of the management team. Topics from technology to business cases and from design to light quality were touched upon in a relaxed atmosphere. Ulrich Schumacher, CEO of the Zumtobel Group, initiated the coherent multi-brand strategy - a "lighting ecosystem", as stated in the new corporate vision - to create unique value for its customers. Together with Michael Ball, EVP at Thorn, and Alfred Felder, CEO at Tridonic he welcomed the journalists, and gave a brief overview of the group structures, company spirit, vision and responsibilities.

For the majority of the 900 guests from over 27 nations, the official part started the next day at noon with a lunch buffet at the Event and Congress Center Bregenz. The next day, product presentations and visits to innovative regional architectural projects ended the event. During the morning the journalists visited the Zumtobel Group Headquarters and were the first ones to experience the latest product developments. The exhibits also included some prototypes that will be officially brought to the market in autumn or at Light + Building 2016.

Zumtobel inspired with their sophisticated approach for lighting systems. Clear minimalistic designs and top light quality and a passion for details and applicability were very impressive.

Their astounding Supersystem will soon be available in a low voltage version and very likely will also be transformed to outdoor products which will add new accents to urban lighting with the aim to make public spaces more attractive and cater to the users' individual needs.

Thorn demonstrated their vision of future urban lighting with the 3D live version of the popular online Smart City experience. The 3D model brings to life the online experience which was launched in 2012. It shows Thorn's interpretations of a smart city: It is one that uses data and deploys technology to deliver public services in innovative ways for the benefit of citizens so that they become more prosperous, ecological and have improved places to live in.



The latest product innovations and upcoming lighting systems of the group brands designed especially for the IYL 2015 were shown at the Zumtobel Group headquarters. Journalists and clients experienced the three different "Limbic Lighting" scenarios (left) that were identified to be most effective of the seven different limbic types. In addition to that and many other interesting products, the Supersystem and its brand new DC derivatives were another highlight. The "Picture Framing" spotlight demonstration (right) was particularly impressive

Tridonic's intrinsic role as provider of the "electronic brain of the lighting system" became especially obvious with the high-end connecDIM solution for advanced, decentralized light management as well as with the simpler, easy to install and configure ready2mains approach. With the TALEXEngine DC String concept that was presented, Tridonic offers a kind of DC micro-grid solution. Beyond that, with the integration of the feature to convert DALI control signals to digital DC power line signals, the system goes even one step further. It is the heart of Zumtobel's coming low voltage DC Supersystem.

The selection of invited speakers and the topics of the speeches also reflected the Zumtobel Group philosophy and their view of the IYL and the future of lighting. The selection demonstrated the commitment to business needs and future technology trends as well as social responsibility and arts.

Olafur Eliasson's talk about "Light is Life" emphasized the influence of light on humans and on social behavior. A good example of this was when he showed people with different interests sharing a public space at sunset. The only thing they had in common was the enjoyment of the situation and atmosphere. He showed his personal view of the meaning of light with his "Rainbow Walkway" that motivates you to actively experience light by walking around and making the light situation change. His "Little Sun" project aims to

provide affordable, clean, solar-powered light to as many people as possible in off-grid areas all over the world.

Prof. Hubert Klumpner talked about "Urban Lighting and Development" in the context of emerging countries and the challenge of city planning for big cities. His examples underlined Eric Hobsbawm's statement that not growth but rather distribution will be the main political issue of the future and pointed out how important it is to identify the needs of the people correctly in order to find the right solution. The impressive Metro Cable and Vertical Gym in Caracas or the inexpensive and quick construction of two-story houses in South Africa are examples that support the conclusion that it is not always advisable to look for a perfect solution, but rather to seek the best and quickest possible solution.

The neuro-marketing experts Dr. Hans-Georg Haeusel and Bernd T. Werner gave a brilliant and witty talk on how the human brain, especially the limbic system, works. They applied this knowledge to lighting; to be more precise, to shop lighting. Besides demonstrating the complexity of describing target groups properly, they explained the seven limbic types and grouped them into three main types in respect to lighting preferences and developed corresponding lighting scenarios: Balance, Stimulants, and Dominance. While the differences between the three lighting scenarios may not all be equally distinct, the results for shops are.

Karl Jónsson, who recently joined Tridonic, entitled his speech, "The Internet of Things and Lighting beyond Light". He covered the evolution from the Internet of PCs to the modern IoT and the IoT of the future with all its consequences - opportunities as well as challenges - for traditional business models and industry. He emphasized the fact that light is already everywhere, that light is connected, and that light has been digital since the introduction of LEDs. This means that doing it right is a big chance for lighting providers because there is additional value and new opportunities that lighting can bring to IoT and vice versa.

Journalists and clients were invited to connect at the Gala Dinner where the winners of the Zumtobel Group Award were announced. Throughout the event the word "connect" with all of its connotations was heard, especially within the Zumtobel Group. The connections between the three brands, the shared passion for light, enhance connections to customers and users. The combined and connected knowledge and experience of the group benefits everyone. Providing connected lighting systems was identified as a technical challenge but also a requirement for the success of future business. The luminaires of the future will be connected to each other and numerous applications, products and services. "Connected" has virtually become a synonym for IoT. The message of the Zumtobel Group is clear: IoT is not science fiction. IoT is now. The future is now. ■

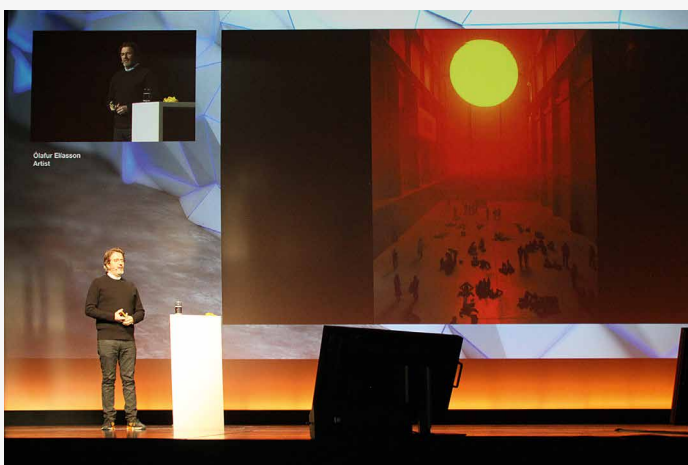

Olafur Eliasson's talk titled "Light is Life" opened an interesting series of speeches. He gave an impressive demonstration of the "power of light" and how it affects people's lives (left). In addition, he showed the audience how the lives of many people could be improved with relatively little effort and simple tools with his "Little Sun" project. Karl Jónsson, IoT architect at Tridonic, outlined a visionary image of future opportunities presented by IoT in the last speech of the day. Afterwards, Alfred Felder and Ulrich Schumacher came to the podium for a short discussion moderated by Rogier van der Heide (right)



SunnyMoney is a pioneering social enterprise owned and funded by the UK based charity, SolarAid. By first sensitizing rural communities and then selling the highest quality, portable and affordable solar lights, SunnyMoney affords millions of Africans living without electricity access to a bright, clean and renewable light source.

SUNNYMONEY - LIFE IS GETTING BRIGHTER

by Linda Wamune, Operations Director, SunnyMoney Kenya

There are over 600 million Africans living in rural off grid communities. Their only option is to turn to expensive, toxic and polluting sources of lighting like kerosene, paraffin, candles and torches.

A single kerosene lamp emits a ton of black carbon into the environment and contributes to global warming. However, for those living off grid there are more dire consequences. Research shows that families spend up to 20% of their monthly income on lighting. This leaves little for education, food or entrepreneurial activities. The impact on their health includes respiratory and ocular complications resulting from fumes emitted from burning kerosene and paraffin.

There is the added danger of fire resulting in loss of property, burns and death.

SunnyMoney currently operates in Kenya, Tanzania, Uganda, Malawi and Zambia. We believe that business, not aid, is a sustainable solution to Africa's energy problem. Working through schools is the first step towards educating and building trust in rural communities. Teachers are respected members of the community. They are capable of quickly sensitizing entire villages while simultaneously sowing the seeds of environmental awareness.

The school program is the catalyst for a solar market in Africa. It establishes distribution channels that not only increase awareness of the technology but also make solar lights available. Campaigns are held in regions that are selected by analyzing the population, electrification and average income.

The Sun King Eco, recently introduced by schools has 3 brightness settings, a separate 1 Watt solar panel, charge indicator and battery monitor, metal stand, 5 year battery life and 2 year replacement warranty. In addition, like all other

SunnyMoney solar lights, the Sun King Eco is World Bank Lighting Global approved. Retailing at USD 10 research shows that with a light, students study on average 2 extra hours a night.

Mobile phone technology is rife in Africa and this has spurred demand for mobile phone charging solar lights. The Sun King Mobile is similar in design to the Sun King Eco but with a more powerful 1.5-Watt solar panel and USB port, users are able to charge their mobile phones. This saves them time, as they no longer need to travel to find a vendor, and money as payment for phone charging is also omitted.

Increasing economies of scale and innovative product development is making solar lights affordable to low income households, and facilitating the economic empowerment of local shops and agents. This is the next step in the evolution of SunnyMoney's solar market development. It helps make solar the go-to option for

lighting and provides employment for local men and women.

The International Year of Light (IYL) as a platform should highlight the parallels between financial poverty and light poverty, and how the reduction of the latter can assist in the alleviation of the prior. There is need for the IYL to boost efforts towards lobbying governments in Africa to offer their support through the removal of value added tax on efficient lighting products such as these. The continual improvement of light technologies, longer lasting and more efficient bulbs, batteries and panels is required as the industry grows. Once the products die there is the need to recycle as much as possible but also to develop safer methods of disposal of parts that cannot be recycled. Finally, SunnyMoney hopes that the IYL is a medium for the collection of evidence on the impact and potential of the emerging solar market and it urges policy makers and other organizations to help support that growth. ■



SunnyMoney's affordable solar LED lights help pupils and students in Africa to study two extra hours a night on average in a healthier environment while helping the parents to save money in a medium term



The Best and Easiest Way to Monitor Global LED Patents

- Daily newsletter for only USD 300.- per year
- Monitoring more than 80 patent offices
- English language



MORE INFORMATION | REGISTER
www.led-professional.com/subscription

First EBV Lighting Academy Summary Report

The first EBV Lighting Academy took place in Munich on March 23rd and 24th. The people attending used this opportunity to learn about LEDs, their structures and why the crucial parameters are the way they are. In addition they also found out about lifetime, light conversion, practical power supply design, thermal management, optics and smart controls for human centric lighting. The two highlights were extraordinary lectures that explained about advanced and future LED technologies. Arno Grabher-Meyer from LED professional was invited to attend the event and summarized the lectures.

Figure 1:
Top speakers from all over the world, like Dr. Young Soo Park from the Samsung headquarters in Korea were invited to lecture at the EBV Lighting Academy

You may ask yourself why a distributor would organize a seminar or if it makes sense to go to all this trouble when there is already a flood of information available and a good number of events that cover LED lighting. Wouldn't a lighting academy be superfluous? If you look at it from a business perspective it is clear: Demonstrating competence and strengthening customer confidence and relationships is very important. But what about the customer? How would they profit if they attended? By setting up the Lighting Academy this year, EBV gave their clients the opportunity to gather information first hand from specialists in various academic fields or from the product suppliers themselves. A number of reputable speakers from various areas of technology were invited to Munich to talk about all the relevant disciplines in LED lighting design. In addition, some of the speakers gave insights into the latest research areas, research results and future developments in SSL. The following is a summary of what was covered.

The Coverage

Distributors are well aware of what topics their clients are interested in as well as which topics their clients may not know much about. Accordingly, the program was set up to cover the full range of basic LED technology, reliability issues on the chip, phosphor and packaging levels, optics, driver design, thermal management and standardization. The program suggested that the question of what is to come is very relevant. Two lectures on "nanostructure LEDs" not only gave an understanding of what it means to structure LEDs and why it is important but also gave an overview of this technology's progress and what innovations are expected in the future.

Day One

After a warm welcome from Sebastian Huelk, Director Vertical Segment Lighting EMEA at EBV, Prof. Dr. Ferdinand Scholz from the University of Ulm gave a detailed introduction to LED manufacturing on a structured sapphire substrate. He started with an overview of the basics and evolution of LED semiconductor technology on the epitaxy level and explained, for instance, that the change from homo-junction to hetero-junction structures in LEDs has been so relevant because the recombination



behavior changed from hardly controllable material parameters to the much better controllable design parameter layer thickness that made LEDs much more efficient. The audience learned that the size of the band gap defines the emission wavelength; red for a small band gap, and blue for a large band gap. And he showed the influence of the used elements out of the periodic system on band gap, wavelength, and other parameters, pointing out why it is tricky to manufacture GaN based semiconductors. He said that in comparison to other semiconductors, the melting point of 2500°C is approximately 2 to 5 times higher and the process pressure with 3×10^4 is between one hundred and a few million times higher. That makes the growth of GaN bulk material, which would be the ideal substrate, very difficult,

if not almost impossible. Alternative methods also have some limitations or drawbacks like the relatively low growth rates of the ammonothermal growth at $T > 133^{\circ}\text{C}$, $p > 11.3 \text{ MPa}$. The Hydride Vapor Phase Epitaxy (HVPE) process allows much higher growth rates at lower pressure, but needs much higher temperatures to produce “pseudo-bulk” substrates. Therefore the current GaN LED mass production is mainly based on other substrates like sapphire and more recently, silicon using the Metalorganic Vapor Phase Epitaxy (MOVPE = MOVCD) process. He continued to talk about the die and package level explaining methods and mechanisms for losses and counter-measures starting with the color conversion mechanisms and reasons for the Stokes losses. He also showed improvements from the early stage to the current date that have increased LED efficacy. In this part of his lecture, Prof. Scholz covered the topics of droop due to the unavoidable Auger effect and the green gap which is mainly an issue of lowered material quality due to different mechanisms like increased lattice mismatch when the amount of Indium (In) is increased to shift the color to lower wavelengths. The losses due to the crystal direction dependent piezoelectric effect also contribute to the green gap. Nonpolar and semi-polar GaN structures are recognized to be one possible solution. Prof. Scholz’s approach is based on a patterned, SiO_2 masked sapphire substrate that inclines the growth direction. It leads to promising results in the range of 519 nm. His presentation ended with an introduction in green laser technology and a look at future technologies and applications to come.

The next speaker, Olli Laakkio, Optics Development Manager at LEDiL, talked about technologies and materials for LED optics. He addressed freeform designs as well as TIR, Fresnel and conventional designs and hybrid optics. He also explained material properties and the pros and cons of different

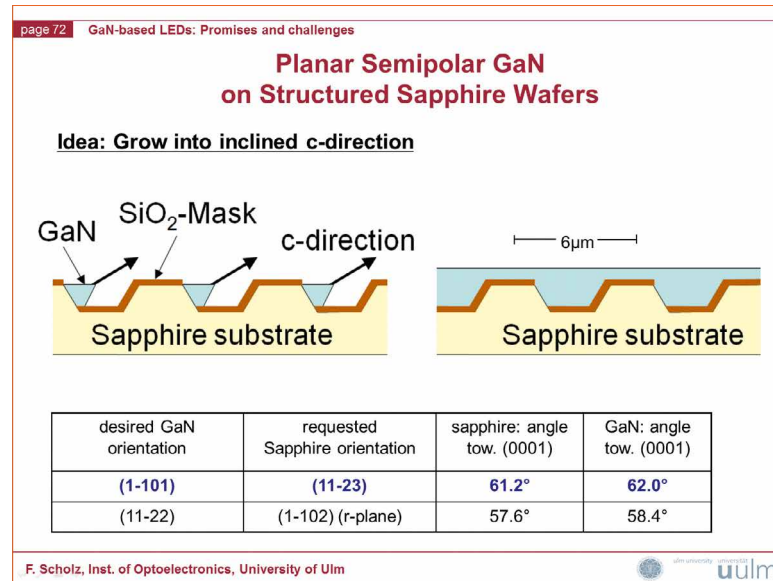

manufacturing methods like injection molding versus compression molding, or row molded versus extruded lenses in respect to application and product type. He also pointed out the advantages of modularization, which allows the design of many different light distribution patterns simply by combining different optics types. He also gave some application examples and an overview on their extensive product portfolio.

After the lunch break Dr. Franz-Peter Wenzl, Head of Research Group “Light and Optical Technologies“ at the Joanneum Research Forschungsgesellschaft, talked about phosphors and white LED packaging. After a short introduction in color conversion materials and methods explaining the most important differences he focused on the general challenges for generating long lasting, efficient high quality phosphor based white light sources and came up with some surprising insights. He defined phosphor thermal issues as one of the main challenges. Bottlenecks on the thermal path in an LED package were identified as the silicone matrix of the phosphor and the conductive glue between the LED substrate and the gold layer of the PCB. This is where the thermal conductivity of the silicone matrix is approximately one tenth of the glue. This is especially relevant because 25% of the blue light energy is absorbed in

the matrix due to the Stokes’ shift losses. Accurate modelling and simulation was used for a detailed analysis of color conversion to answer questions regarding light quality, efficiency and thermal issues. One result he presented was that for every combination of LED die with a specific phosphor and phosphor concentration and for a defined CCT, one set of dimension for the color conversion layer exists that provides optimized angular color homogeneity. As a result, varying the phosphor concentration and adjusting the layer thickness for a constant broadness delivers a wide range of color temperatures. Many other parameters like the influence of the extinction coefficient and the quantum efficiency, and the effects of the particle size in conjunction with the refractive index of the matrix in respect to efficiency and color homogeneity have been investigated, just to name a few. A big part of the lecture dealt with the thermal properties in the color conversion system of white LEDs. It was shown that in a setup with a boundary condition to hold the heat sink constant at 300 K, the temperatures in the phosphor matrix can easily exceed 150°C . The increased Stokes losses should not be underestimated when, for instance, the center peak wavelength is increased from 505 nm to 625 nm at an I_f of 1000 mA LED the temperature rises by approximately 20°C .

Figures 2: Prof. Dr. Scholz and his team at the University of Ulm investigate the production of planar semi-polar GaN by growing it in an inclined c-direction using structured and masked sapphire wafers [1]

Figures 3: Dr. Wenzl from Joanneum Research showed which parameters have to be considered when applying phosphor to perfectly tune properties like angular color homogeneity and thermal behavior. For instance, for each type of LED and phosphor concentration in the silicone matrix one optimum set of dimensions that provides the best angular color homogeneity exists [2]

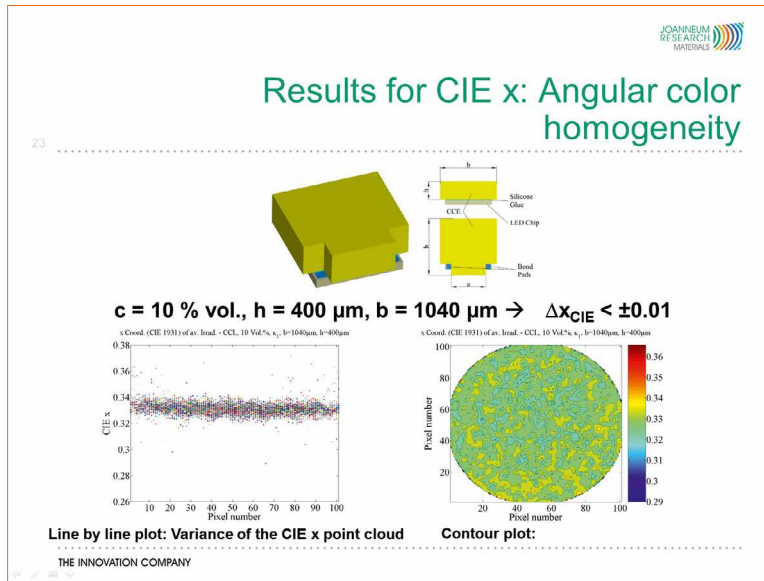

An enhancement option for the thermal conductivity is reducing layer height while increasing phosphor concentration to a level that results in the same CCT. In this particular case, this leads to a temperature reduction of more than 10°C for 100% Quantum Efficiency (QU) and over 30°C at 70% QE, respectively. Increasing thermal conductivity by using other matrix material is another option. Ceramics is basically a good candidate, but the manufacturing process is more sophisticated. Dr. Wenzl concluded his lecture with a quick look at the future of color conversion.

In his function as Chair of the Zhaga Steering Committee, Arnulf Rupp from Osram GmbH,

gave an overview of the status and ongoing standardization activities of Zhaga. After explaining the aims of Zhaga and giving a quick summary of the older Zhaga Books, he focused on the current work on Books 9 to 11. These Books cover a module specification for a ring shaped LES of 12 or 25 mm (Book 9) and two extensions of the Book 3 specifications for a smaller module diameter of 35 mm (Book 11) and an enlarged 75 mm module size (Book 10). The first prototypes for the Book 9 specifications are currently being tested by authorized test centers. An additional Book for driver specifications has just been started. One very important issue is the specification of the driver interface for LLEs with external

drivers to enable independent interchangeability of LED modules and drivers. An output current range from 50 mA up to 8 A will be covered by defining a relationship between IOU_T and RSET. Another, ambitious standardization task that is just starting, concerns COB LEDs. Split into two phases, the basic physical dimensions will be defined first and then the integration of new features and a higher integration level will be proposed in phase 2 (the first detailed articles on this Book will be published in LpR 51 – Sept/Oct 2015 issue).

The topic “Nanostructured LEDs for Solid-State Lighting” presented by Prof. Pei Cheng Ku, Associate Professor for Electrical Engineering and Computer Science at the University of Michigan completed the sessions on the first day. After a short journey into the evolution of LEDs and their success story, he explained why and how nanostructured surfaces either of the substrate or the LED’s emission plane improves light extraction efficiency and even allows beam shaping. He also explained different efficiency limiting effects, and offered a solution to reduce the impact of the piezoelectric effect by strain relaxation in InGaN active regions using nanostructures. The second part of Prof. Ku’s lecture covered more visionary ideas and solutions. He also challenged the almost dogmatic view of incandescent light being none plus ultra when he showed that the spectral distribution is by far not the distribution of a Planckian radiator that it is said to be. He likewise showed how different natural light, for which our eyes should be optimized, appears depending on the time of day and other factors. He asked that we not stick to old habits, but rather to use the opportunities afforded by LED to tailor the spectral emission pattern using RGB or additional colors. He noted that nanostructured LEDs are a viable solution.

Figure 4: Zhaga is continuously working on new specifications requested by the industry. The current phase concerns COB form factors and will be followed by defining possible higher integration levels for enabling new features [3]

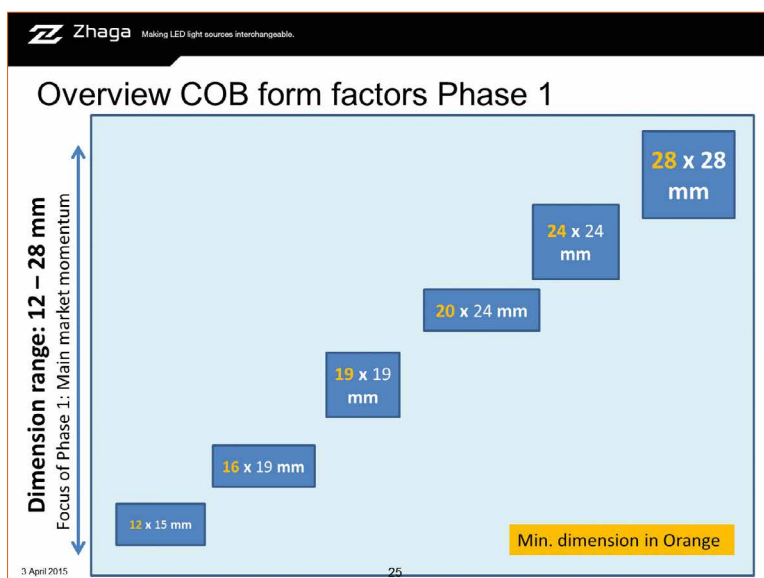

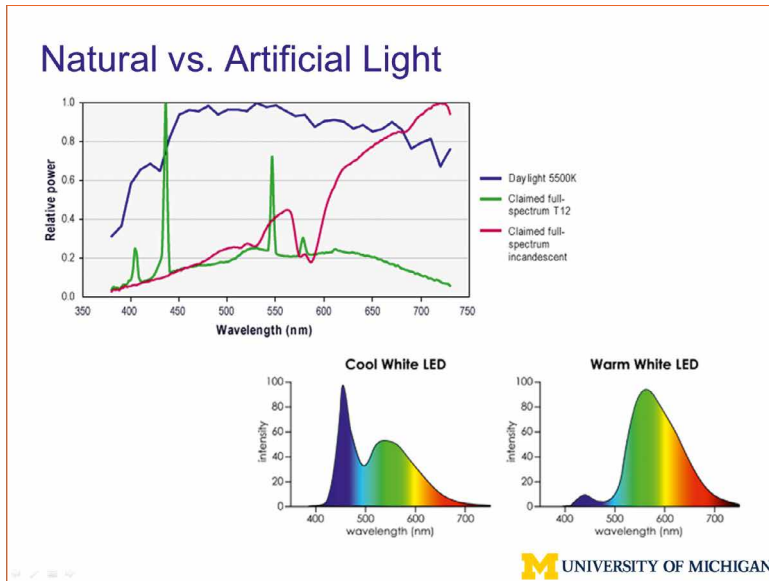

Day Two

On the second day, Ron Lenk, Consultant in Power Supplies in LED Drivers, opened by stating that while most LED systems are based on white LEDs with a CCTs from approximately 2500 K to 6500 K there are still some issues with color rendering and CCT variations. Furthermore, the full potential of LEDs is unused and high quality RGB or RGBx systems could offer better, high quality solutions. He went on to say, "Control of these systems is complex and more costly, and today it's lm/\$ that counts, not lm/W anymore." This was followed by a thorough discussion of the challenges of designing LED power supplies for different applications. Useful diagrams making the driver issues

more easily visible were generated using the usual LED datasheet curves. The practical design suggestions included various issues like defining the right operating point for a determined operating temperature and flux. Topics like Mean Time to Failure (MTTF) and how to correctly handle the "prime culprit", the electrolytic capacitor, were addressed as well as the basic SMPS topologies and AC direct drives. Mr. Lenk specifically pointed out issues that are often overlooked. Power grids vary dramatically worldwide from 100 V up to 347 V, but poor regulation in some regions often leads to fluctuations that can range between below 80 V and up to more than 400 V. A universal power supply needs to be able to

withstand and work correctly in these extremes. Lighting and the related surge protection is also an underestimated topic. It was emphasized that no matter what lightning protection is used, the voltage at the output of the lightning protection is going to rise above normal and therefore the voltage rating of the components should be amply dimensioned. Another topic he touched on was thermal management. While everybody is aware of the LED thermal requirements not everyone knows that LED drivers also need to stay cool. To ensure appropriate MTTF the used components should also have high temperature ratings, e.g. 125°C. Simple but effective steps define the worst-case ambient temperature, estimate heat sink temperature, determine PCB temperature and, finally, LED Junction temperature. In addition, he showed that while the differential equations of thermal and electrical models are isomorphic, a spice model can also be used for basic thermal calculations.

The next lecture was entitled, "Thermal Management of LEDs – A High Level Overview" by Prof. Dr. Mehmet Arik from the Ozyegin University Mechanical Engineering Institute covered points brought up in the preceding lecture in more detail. The talk began with a short overview and the facts pertaining to the influence of temperature on LEDs, and clearly pointed out that LED lighting products are complex systems that require interdisciplinary research and approaches. He demonstrated that LED systems basically offer two cooling paths. One of these paths, usually on the front side, containing the phosphors and optical system, is not very efficient. Therefore the second path, usually equipped with a heat sink, takes the main load. Then he began to show the issues in detail, starting on a chip level. Today, 60-70% of the electrical input power is still converted into heat and can cause hot spots due to current crowding or bonding defects. He also mentioned the effects of different types of

Figure 5: Prof. Ku from the University of Michigan issued the current color rendering metrics problem when comparing the spectral distribution of so-called full spectrum lamps with natural sunlight [4]

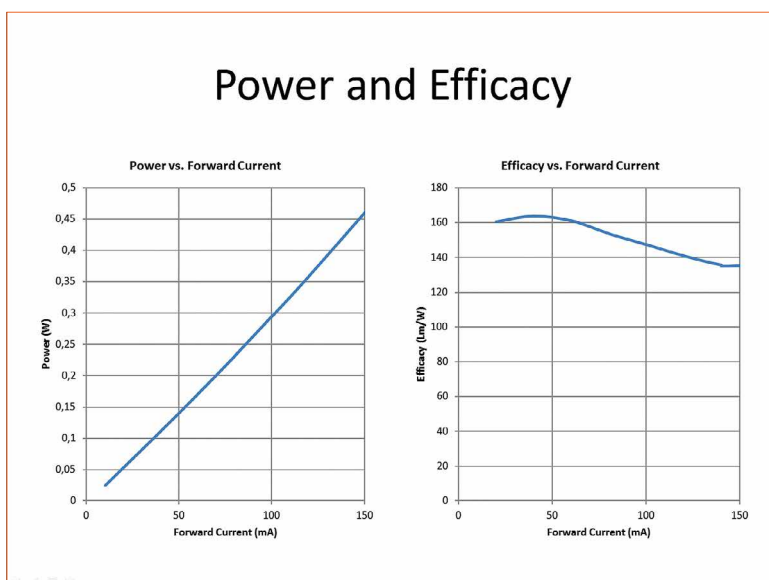
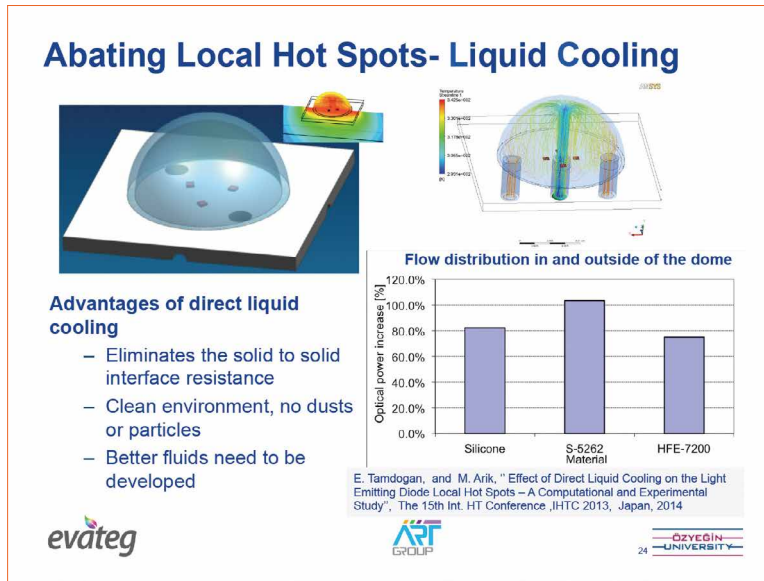

Figure 6: Ron Lenk showed very useful diagrams that are not provided by LED manufacturers and that need to be generated from the standard LED datasheet diagrams; here power and efficacy vs. forward current [5]

Figure 7: Prof. Arik's team at the Özgün University and partners are investigating new solutions for thermal management like direct liquid cooling [6]



phosphor distribution as well as issues due to interaction between the LED die, environment and packaging materials. On the light engine level he discussed the pros and cons of different PCB materials before he proposed a direct liquid cooling approach to defend hot spot formation. Thirdly, he explained that he sees the System Level Thermal Management as the final part where lighting companies may integrate game changing technologies. Some examples for that were advanced heat sink designs, sync jets, heat spreaders and heat pipes. In the last part of his lecture, Prof. Arik highly recommended that a combined analytic, computational, and experimental approach to solve thermal design issues should be strictly followed. Different tools like

MatLab or Excel can be used for a first analytic model that may be simple one dimensional resistance networks. In conjunction with a PARETO chart, the most critical components and points can be identified. In a next step the computational models using tools like ANSYS or CFX give a more detailed picture and allow the spatial localization of critical hot spots. The experimental evaluation with sensors and thermos imaging is inevitable for validating the design.

Osram Opto Semiconductors' Dr. Ulrich Keutz, talked about lifetime and reliability considerations of LED systems and covered robustness tests, lifetime, degradation mechanisms, second board reliability, and LM-80 tests.

Robustness tests are an integral part of a product development process to define material properties and to select the appropriate materials for a product. This includes the evaluation of failure modes. He also explained the meaning of LxBy lifetime values and consequences, introduced Design of Experiment (DoE), choice of the model function which describes the observed aging behavior best at high stresses and the influence on the L value. He also indicated the impact on the result that is caused by the selected sample size. Dr. Keutz then showed how extrapolation is done by determining the acceleration factor for the results at, for instance, 85°C and 125°C. In the segment about degradation mechanisms, he identified four main issues in white LEDs; initial and long-term chip degradation, package degradation, and converter aging. While temperature concerns all degradation phases, initial and long-term chip degradation is also influenced by current, converters by light intensity and humidity, and packages by short wavelengths. The second board reliability is influenced mostly by the different thermal expansion of the LED and the PCB which may cause cracks in the solder joint. Finally he explained how LM80 and TM21 testing and extrapolation is done. He pointed out the main advantage of this regulation that is the unified and standardized method to test and extrapolate the results and report to deliver comparable data to the customer.

Figure 8: Besides other interesting aspects regarding lifetime and reliability, Dr. Keutz explained how to extrapolate lifetime predictions. The fact that the acceleration factor is a constant value makes it a relatively simple calculation [7]

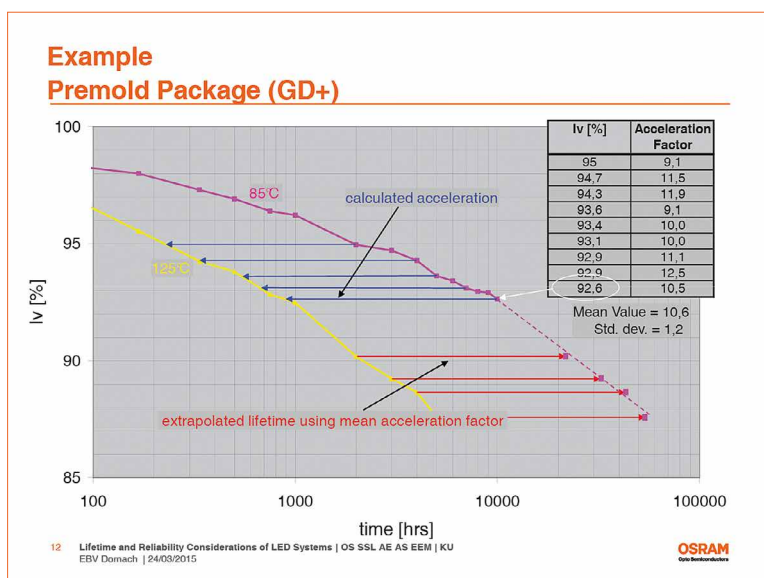

With the topic "Electronic Lighting Design and Solution Proposal for Human Centric Lighting (HCL)", Andreas Jansen, FAE at Infineon, covered a hot topic. He demonstrated the advantages of μ Cs, and in particular, the dedicated XMC1000 MCU family, for HCL. Valuable features are the automatic smooth color change and exponential dimming, but the Dedicated Brightness and Color Control Unit (BCCU) should be especially highlighted. It allows automatic control of multi-channel LED

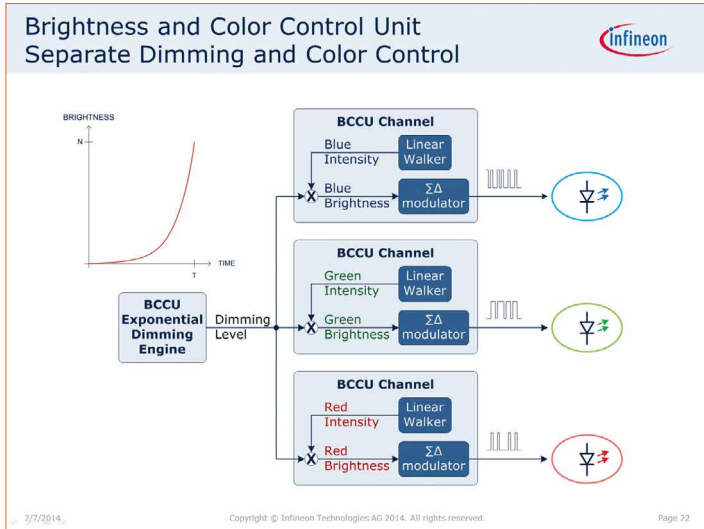

Figure 9: A big advantage of dedicated MCUs is the integration of specific processor units that take over tasks from the main CPU. This example shows how, if designed in an intelligent way, dimming and color control are separated, making the lives of engineers easier [8]

systems and provides pulse-density modulation (PDM) based flicker-free dimming. Based on the requirements and features of the presented MCU, he explained the basics of driving LEDs, including the major dimming methods - analog and PWM with their pros and cons – and their approach of a $\Sigma-\Delta$ modulator related Puls-Density Modulation (PDM). After briefly showing the advantages of their system approach and the functional principles of the major components, he gave an overview of the advantages of human centric lighting and demonstrated a CCT tunable demo setup.

The event culminated in a very visionary lecture showing the future of solid-state lighting. Dr. Young Soo Park, Senior Vice President of Research & Development at Samsung Electronics talked about Nanostructured LEDs for Solid State Lighting and gave a good picture of the company's research and product roadmap. According to Dr. Park, Samsung also currently sees costs as the most powerful driver. Their short to mid-term strategy is advances in

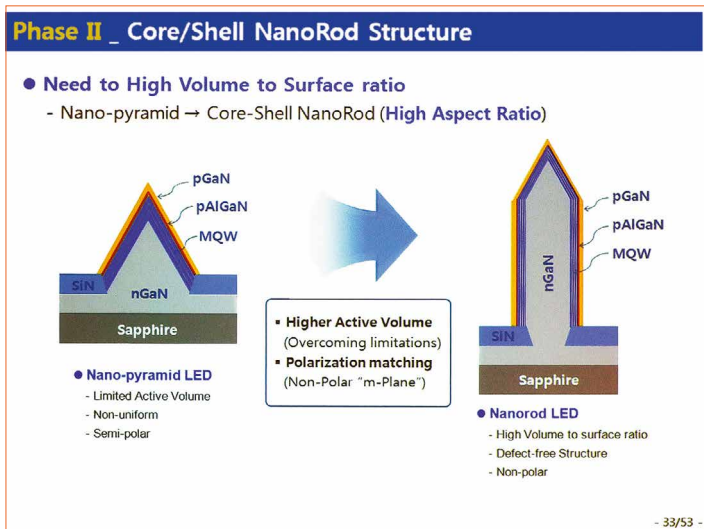
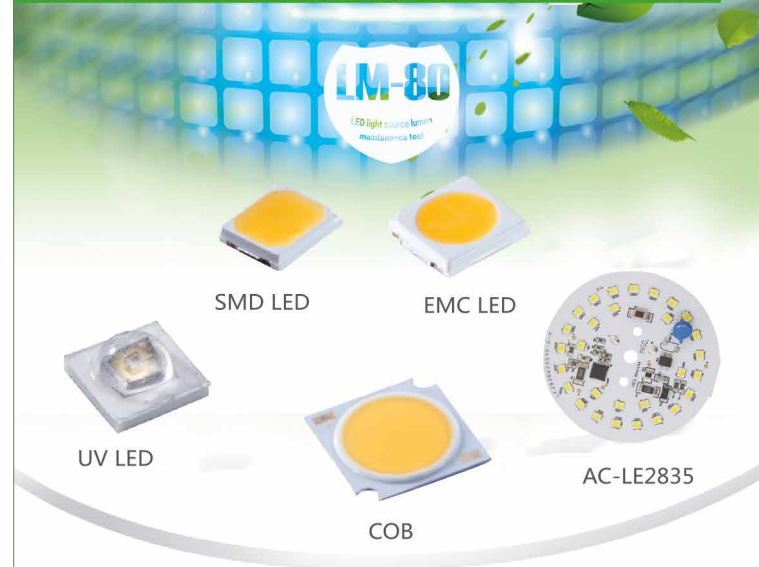

Figure 10: The highlight of Dr. Park's lecture was his very detailed explanation of Samsung's progress in nanorod GaN LED technology. One of the important steps has certainly been the transition from the relatively simple production of nano-pyramids to more complex but also more efficient nanorods [13]



HONGLITRONIC
鸿利光电
Stock Code: 300219

We are Leading the White Light LEDs



Welcome to **Guangzhou international lighting exhibition**

Date: June 9-12th,2015

Booth No.: **Hall 10.2, C02**

Ranked NO.1 in China by GLII for Business competitiveness in White Light LED Encapsulating; In 2014 COB packaging production value ranks the first in China (GLII).

1,500KK Pcs month production capacity
First manufacturer in China to pass the IES LM-80
EPA Recognized certification laboratory



Guangzhou Hongli Opto-Electronic Co., Ltd

E-mail : sales@honglitrionic.com

Tel : +86-20-8673 3333 ext 3033

Fax : +86-20-8673 3883

www.honglitrionic.com



Official website Official wechat

GaN-on-Si technology and chip scale packaging. But at the same time he asked for technologies for next generation lighting. While not being able to present all the details he did give some exciting insights when he took up the ideas presented 24 hours prior to his lecture by Prof. Ku. While non-polar and semi-polar LEDs could lead to some progress, nanorod based LEDs seem to be the most advanced and promising technology to follow. While he expects conventional LED technology to get stuck at 230 lm/W efficacy, the new technology should allow 300+ lm/W. Longitudinal and core shell hetero-structures can be grown. The latter seem to be more suitable. This technology allows for the manufacturing of white LEDs

without using phosphors on one chip by tuning the dimensions width and height of the nanorods leading to different emission wavelengths. In the current status an RGB approach is under investigation, but also LEDs with more than three different emission peaks can be designed (different patent applications [9, 10, 11, 12] give some more details). However, some additional research is needed to learn more about crystalline defects on semipolar facets, atomic diffusion behavior, photon recycling, strain and piezoelectric fields. In addition appropriate hardware for mass production, analysis and inspection tools need to be developed. Although, Dr. Park is confident that in 2-3 years mass production could start.

Summary

This first time event, while being one of the smaller ones had a very good pick of topics that covered the most relevant aspects and system levels of LED lighting. In addition, we were given practical advice from skilled industry speakers and got to listen to some outstanding speakers from academia with their excellent expertise. The surprising presentation of a true future technology made these two days very interesting and instructive. I'm looking forward to the next EBV Lighting Academy and can't wait to find out which speakers they will procure. ■

References:

- [1] LED Manufacturing on Structured Sapphire Substrate, Prof. Dr. Ferdinand Scholz, Institute of optoelectronics, University of Ulm, EBV Lighting Academy, 2015.03.23
- [2] Phosphors and White LED Packaging, Dr. Franz-Peter Wenzl, Joanneum Research Forschungsgesellschaft, Research Group Light and Optical Technologies, EBV Lighting Academy, 2015.03.23
- [3] Zhaga Lighting Standards, Arnulf Rupp, The Zhaga Consortium & Osram GmbH, EBV Lighting Academy, 2015.03.23
- [4] Nanostructured LEDs for Solid-State Lighting, Prof. Pei Cheng Ku, Institute for Electrical Engineering and Computer Science, University of Michigan, EBV Lighting Academy, 2015.03.23
- [5] Practical Lighting Design with LEDs, Ron Lenk, EBV Lighting Academy, 2015.03.24
- [6] Thermal Managements of LEDs – A High Level Overview, Prof. Dr. Mehmet Arik, Mechanical Engineering Institute, Ozyegin University, EBV Lighting Academy, 2015.03.24
- [7] Lifetime and Reliability Considerations of LED Systems, Dr. Ulrich Keutz, SSL Department, Osram Opto Semiconductors, EBV Lighting Academy, 2015.03.24
- [8] Electronic Lighting Design and Solution Proposal for Human Centric Lighting, Andreas Jansen, Infineon, EBV Lighting Academy, 2015.03.24
- [9] US 8,735,867-B2 from May 27, 2014, Assignee: Samsung Electronics Co. Ltd.
- [10] US 8,853,671-B2 from October 7, 2014, Assignee: Samsung Electronics Co. Ltd.
- [11] US 6,596,186-B2 from July 22, 2003, Assignee: Samsung Electronics Co. Ltd.
- [12] US 6,858,081-B2 from February 22, 2005, Assignee: Sony Corp.
- [13] Nanostructured LEDs for Solid State Lighting, Dr. Youngsoo Park, Samsung Electronics, EBV Lighting Academy, 2015.03.24



Daniel Doxsee
Deputy Managing Director
Nichia Chemical Europe
LpR 49
May/June 2015



Ewing Liu
Technical Marketing Manager
Everlight Americas
LpR 48
March/April 2015



Mehmet Arik
Associate Professor
Ozyegin University
LpR 47
Jan/Feb 2015



Jiangen Pan
Founder & CEO
Everfine
LpR 46
Nov/Dec 2014



Dietmar Zembrot
Former President
Lighting Europe
LpR 45
Sept/Oct 2014

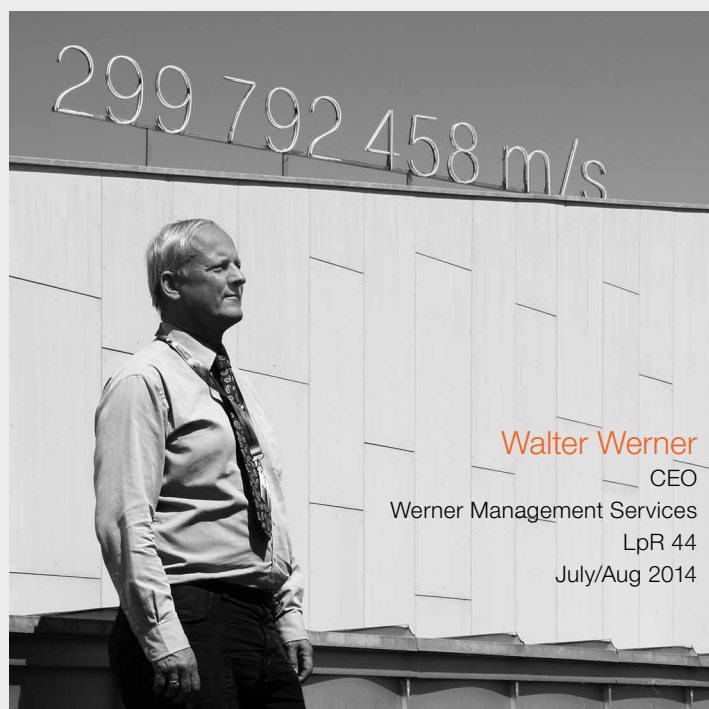

Walter Werner
CEO
Werner Management Services
LpR 44
July/Aug 2014

Tech-Talks BREGENZ - Daniel Doxsee, Nichia Europe, Deputy Managing Director



Daniel Doxsee

Daniel Doxsee is the Deputy Managing Director of Nichia Europe, which he joined in June 2014.

He currently leads the commercialization of Nichia's LED products for lighting applications in Europe, based in Frankfurt, Germany.

Daniel first joined Nichia Corporation in 2004 at Nichia America, where he served as Vice President, based in Detroit and oversaw the expansion of Nichia's lighting and automotive businesses in the US, Canada and South America.

Prior to joining Nichia in 2004 he spent 6 years with GE Lighting's LED division in various roles in Engineering and Product Management.

Daniel is a native of Canada and received his Ph.D. in Inorganic Chemistry in 1992.

Nichia is arguably the company with the longest history of manufacturing white LEDs. Recently, however, new competitors especially from China, have started challenging Nichia's market share. Nichia's role in strategic and technical solid-state lighting issues and its past, present and future were discussed with Daniel Doxsee, Nichia Chemical Europe's Deputy Managing Director.

LED professional: Could you give us an overview of the Nichia Corporation?

Daniel Doxsee: Nichia is a privately held, family owned company, very focused on technology. It is located on the Shikoku Island in Japan. Mr. Nobuo Ogawa started the company in 1956 and the current chairman is Mr. Eiji Ogawa. Historically we were called Nichia Chemical. We basically started as a chemical company focusing on calcium materials and our first business was making high purity calcium compounds for the medical industry. In the 1960s, GE discovered a material for fluorescent lamps called calcium halo phosphate, which they patented but could not produce in production scale quantities so they partnered with Nichia. GE gave the rights to Nichia who then learned how to

make this material in very high quality, in production scale. Then they sold it to GE and other companies and still do. Currently, our main products are optical semiconductors, LEDs, laser diodes. We have also been the world's largest phosphor manufacturer for several decades. Recently we started making the cathode materials that go into Li-ion batteries. We see that as a very important market in the coming years not only with mobile devices but also with electric vehicles. Next year is the 60th anniversary of the company and the 20th anniversary of the introduction of the world's first white light LED by Nichia.

LED professional: Could you tell us about the scale of the business and how Nichia maintains its high quality?

Daniel Doxsee: We are not only known as a very innovative company and the inventor of the technology but an extremely high quality manufacturer which we feel is extremely important especially for the lighting industry. Our failure rate is less than 1 ppm and has been for many years. We test virtually 100% of our LED production. In addition, we do accelerated life testing on samples from every lot of LEDs and only ship after the testing is completed and the lot is certified. If people have a bad experience from a quality perspective, this is not only bad for that particular luminaire or lamp manufacturer, it is bad for the industry as a whole.

LED professional: What is the business structure and philosophy of the company?



Daniel Doxsee and Amrita Prasad talking in front of the floating stage with Turandot's "Chinese Wall"

Daniel Doxsee: Nichia has three different main businesses. Besides our historical business as a phosphor manufacturer for fluorescent lamps and other applications, Nichia is the leading maker of materials for Li-ion batteries, and we are the world's largest LED manufacturer. Nichia was also the first to develop a warm white LED and the first to bring a high CRI LED to the market. Right now more than 80% of our revenue comes from optical semiconductors. We focus very much on innovation and technology, and we want to bring technologies that benefit the world and not just concentrate on good business for us. All three of these businesses have environmentally friendly benefits and that is very important to the management of our company. We see a huge benefit to society as a whole from an energy savings point of view from converting conventional lighting to solid state. The overall philosophy is to make a contribution to society.

LED professional: How has the company evolved since the invention of the blue and white light LEDs?

Daniel Doxsee: The company evolved in four stages. From a high purity chemical company for the medical industry to manufacturing phosphors for fluorescent lamps, followed by phosphors for CRTs. In 1993, the fourth stage began with the commercialization of the world's first high brightness blue LED and this was quickly followed by the green LED. Then in 1996 the first white LED was introduced. The first big wave for Nichia was the mobile phone market in the early 2000s when the first mobile phones started using full color screens. This was driven by Nichia developing the world's first side-view white LED, which simplified the white LED coupling with a light-guide as a backlight for LCD panels. As the technology evolved and the lumen per watt and package power became higher, the amount of usable light became interesting from a lighting

perspective and this saw a ramp up in the penetration for use in the general lighting market for many players including Nichia but it was much longer and slower.

LED professional: Has the proportion of LCD backlighting diminished compared to general or automotive lighting?

Daniel Doxsee: Automotive and lighting are growing very fast. LED forward lighting has driven the automotive sector growth. LCD backlighting is still important for Nichia and that is also driving innovation. The backlighting market for LED manufacturers is still growing, just not at the rate of lighting and automotive, as it was not limited to mobile phones, tablets, and laptops. There is proliferation of devices into LED TVs and many applications that didn't seem obvious like putting LCD screens into white goods. The market went to very hybrid and brand new applications enabled by LED technology.

LED professional: What is Nichia's product portfolio and main product lines?

Daniel Doxsee: In terms of our LED business we are strictly a component manufacturer and we deliberately don't sell just the chip, phosphor or finished products. We think that the best way to get the value out of our chip and phosphor technology is to package that into an efficient LED ourselves and we also don't want to compete with our customers. In terms of just the LED package as our finished product, there are three main components; there is the chip technology, phosphor technology and actual packaging technology. We do all our own chip and phosphor manufacturing. We also make our own equipment for MOCVD. In the early 90s you couldn't buy MOCVD tools for the type of GaN technology that we were developing so we built our own. We make 100% of the tools at key process for making an LED.

LED professional: Could you tell us about your laser diode technology?

Daniel Doxsee: Laser diode technology is closely related to LED technology on the chip level. Nichia was the first to introduce blue laser diodes that are widely used in consumer electronics like in Blu-ray and projector technologies. Projectors were using vacuum tube sources with life and heat issues and the laser diode is particularly applicable in that area because of the very high luminance that you can obtain. Our experience in the last 10 years in the consumer projection market using blue laser diodes is now being translated into the automotive forward lighting market. You've seen certain automotive OEMs announce the use of laser diodes for very long beam technology with up to 1 km in throw. The more innovative OEMs, especially here in Europe, are very actively and vigorously pursuing that technology. So, blue and white laser diodes are becoming a much more important market for us. The spot luminance levels that you can attain are much higher with laser technology than with LEDs. With that being said, we are also pursuing higher luminance LED technology.

LED professional: Could you tell us about how the lighting market has evolved and what is the state-of-the-art?

Daniel Doxsee: Basically, we see the lighting market delineating in a few different ways. On the indoor side it is cost effective luminaires and lamps while for outdoors it is more performance luminaires for street lighting, etc. The indoor market is not so much about precision optics or extreme conditions of operation like street lighting or automotive markets. Often it is in a controlled environment that you are trying to deliver light as efficiently and cost effectively as possible. When the indoor market for SSL was still emerging a decade ago they were mainly using high power style LEDs

and we always heard that LED technology is great but the payback is too long. For the indoor market, Nichia found that the cost per lumen dropped significantly by moving to smaller chip or multiple smaller chips in a single package because the yields at the wafer level went up. The lumen per dollar factor really drove us to innovating in the mid-power area. These are used very extensively in indoor markets, especially commercial and consumer markets. Even the industrial markets that still require a higher lumen level are moving towards a cost effective mid-power range using many LEDs.

The use of mid power LEDs also makes sense aesthetically in some applications. In a linear application where you are trying to replace a fluorescent troffer, early designs used high power LEDs and very often the light was non-uniform with a lot of glare. With mid power LEDs you now have this very beautiful, uniform looking light with low glare and high efficacy. In an environment where workers have to look up, using very high power LEDs with lot of glare creates a difficult working environment. Mid power LEDs spread the light over a larger area reducing the glare, reducing the cost and increasing efficacy. Thermal management is also better because you spread the heat over a larger area

LED professional: What about the outdoor market?

Daniel Doxsee: The outdoor market has traditionally used high power LEDs and we see this delineate into 2 types; street lighting is a market for large, single chip high power LEDs where you need to optically control the light in a precise way for pattern and uniformity. For more general illumination like pathways or outdoor public spaces where the optical spread of the light is not such a challenge, the market is moving towards multiple low power LEDs for both cost and glare reasons. Even in street lighting some manufacturers are moving towards

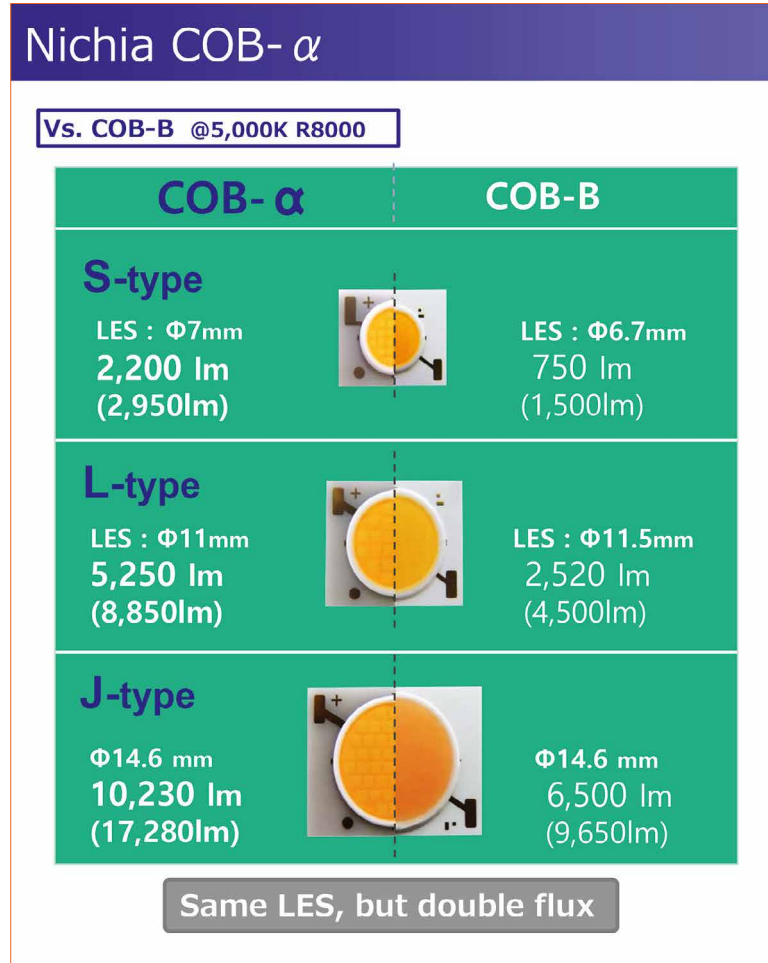

COB lineup and comparison of the new COB- α with COB-B

mid power. One other area is the COB LED and we see some specific markets where this is ideal, like directional lamps and recessed lighting. COB gives a nice uniform look, such as one core solution. It is still to be seen what other markets COB can expand into. The typical benchmark for state-of-the-art efficacy is somewhere in the cool white, 5000 K and we are in excess of 200 lumen/watt.

LED professional: Very high efficacy LEDs are usually interesting for outdoor lighting where you don't need high CRI. What about the CRI considerations for different applications?

Daniel Doxsee: We are also seeing some outdoor applications where they want high CRI but yes, usually a CRI of 80 is enough and they tend to be cooler white around 4000-5000 K. Indoor tends to be much warmer and high CRI is much more common. We are actually seeing applications where the

customers want emphasis on certain parts of the spectrum. We can make phosphor blends for different types of lighting. High CRI for retail, enhanced red for meat retail and some primary color phosphor blends for produce lighting.

LED professional: Could you comment on Nichia's competency and approaches towards packaging technologies?

Daniel Doxsee: Nichia is doing a lot in actual package material technology. Some manufacturers claim that mid power LEDs are not as reliable as high power LEDs and while there is some truth to that, the reason is mainly the package.

There are a few different styles in packages; mid power, high power and COB. High power LEDs tend to be ceramic, which is optically stable but not very reflective. Mid power are very often resins, which are cheaper and highly reflective so the initial lumen/watt can look attractive

Daniel Doxsee uses the flip chart to explain different phosphor coating approaches



but many resins absorb blue light and the top monolayer decomposes. There is discoloration, color shift and lumen depreciation. The degradation and color shift happens faster under high temperatures. Consumer level bulbs are not sold with a meaningful warranty and bulb manufacturers are strictly looking at efficacy and cost. If you are selling a commercial luminaire it is almost always sold with a meaningful warranty. That is where the reliability and color stability are very important especially for mid power because these are all indoor applications.

Ceramics are excellent from a lifetime perspective because they are usually optically and chemically inert so for an industrial environment where you might have halogen or sulfur gases, ceramics won't be affected. The highly reflective resins usually will be very affected, but Nichia has developed a special composite material, a thermoset material that has the resin optical reflective characteristics without the degradation. As the only manufacturer, we already provide this technology for mid power LEDs. The color and lumen stability at maximum drive current elevated

temperature and chemical (sulfurization) tests show a positive difference between using a pure resin vs. this high quality composite.

LED professional: Could you tell us more about the package-less flip-chip technology that has been announced by Nichia with 1/9th of the size of standard LEDs, which will be launched in October 2015?

Daniel Doxsee: There is a tremendous amount of price erosion and price pressure due to great penetration in the lighting market. This drives us to be innovative in how to deliver reliable SSL in a cost effective way. We are developing "wafer level package" LEDs which is the next evolution of package-less technology for Nichia. This is a freestanding chip that has the electrodes built directly on the back. We can conformably coat phosphor on the top of the chip and that's it! No ceramic carrier, no resin package to put the chips and phosphor into. It is the simplest bill of materials for an LED. However, there are two handling challenges. There are no Zener diodes, so protecting from ESD during pick-and-place and also protecting at the board level for ESD is

a challenge. We are researching ways to make chips that are strong against ESD without any additional components. The second challenge is direct reflow, because the pad sizes and the gap are very small so precision in pick and place is very important. It is structurally the simplest LED and since there is no dome or secondary optics built into the LED, if you are using a secondary optic in your product, you can get the lens very close to the LED. That improves the optical extraction through the lens. We plan to launch these types of products this year.

LED professional: What is the light distribution for the wafer level package LED?

Daniel Doxsee: When the phosphor layer is just on the top, it has a Lambertian distribution. We are also doing a high luminance style LED for certain applications. In a third version, we can coat the sides of the chip with phosphor and give a very wide directivity. There are some options in terms of the optical characteristics of a wafer level package that can be designed.

LED professional: Could you comment on some main trends for Nichia with wafer level packages and SSL in general?

Daniel Doxsee: We'd love to talk more about "sexy" applications like solid-state lighting of the Ponte Vecchio in Italy that we did recently and are proud of. But there has been a very intense drive towards not only high efficacy but also cost effectiveness and user experience for large level penetration. The first white LEDs we introduced in the 90s could have been 100 dollars/lumen, now it is at a point where the cost of light is on par or even lower than the incumbent technology. The replacement model was used a lot by the lighting industry in the past. With SSL, it is our hope and goal that people will put a lot more effort into intelligent design and quality of light. The efficacy is far ahead of any older technology.

I'd rather have a higher CRI with perfect color temperature and a very tightly controlled LED-to-LED color control than just a cheaper one.

There are also some types of non-obvious technologies that Nichia is bringing to the market based on our phosphor technology. We've developed blends that are of specific interests for example, in meat lighting. In the supermarket business, produce and meat generate more revenue. People associate dark red meat with good taste. With phosphor technology you can enhance the red and we have customers who have successfully implemented this. Furthermore in retail when you have produce with a rich variety

of colors you would want to enhance the primary colors. Tri-band fluorescence is often used in the produce sector. The third one is to make a very "pure" white and that can be of interest especially in clothing retail. We have developed special blends where we achieve this by suppressing the green. We are implementing that in COB arrays and also in mid-power LEDs.

LED professional: Does Nichia have a team to support clients with education about product design?

Daniel Doxsee: We certainly put a lot of effort into getting the details of the characteristics of the LEDs and making sure the customer understands that. We have a lot of

knowledgeable and technical people worldwide and we get a lot of support from headquarters. We actively try to ensure that the people setting the standards and guidelines get the information about LED technology and we want to be an education resource for the market in general as well as government and standard setting bodies to help them make coherent guidelines.

LED professional: Thank you very much. ■

ELECTROLUBE

THE SOLUTIONS PEOPLE

Superior resins engineered for challenging environments

In Encapsulation Resins our comprehensive range meets the increasing demands of the electronics industry. Whether it's epoxy, polyurethane or silicone resin systems, our products are designed to protect and insulate printed circuit boards (PCBs) and electronic components from the threats of harsh and challenging environments.

Encapsulating the entire device in resin offers protection against moisture, vibration and rapid changes in temperature, thus offering superior performance under extreme conditions.

Whether for general purpose or tailored for individual requirements, every electro-chemical solution is within our spectrum. Our specialist approach to problems has established us as a key provider and developer to the technical electrical industry, both commercial and domestic.

Isn't it time you discovered how Electrolube can serve you?

+44 (0)1530 419600
www.electrolube.com

Scan the code to discover our full spectrum of superior Encapsulation Resins and electro-chemical solutions.



Electronic & General
Purpose Cleaning

Conformal
Coatings

Encapsulation
Resins

Thermal Management
Solutions

Contact
Lubricants

Maintenance
& Service Aids

A Self-Compensation Approach for Maintaining the Chromaticity Coordinates of Phosphor Converted LEDs Upon Temperature Variations

Solid-state light sources for general illumination applications are currently becoming more and more popular. Maintaining chromaticity coordinates over temperature is a challenge. Wolfgang Nemitz, Franz P. Wenzl, Susanne Schweitzer, Christian Sommer, Paul Hartmann from the Institute for Surface Technologies and Photonics at Joanneum Research, and Paul Fulmek and Johann Nicolics from the Institute of Sensor & Actuator Systems of the Vienna University of Technology investigated this issue and propose a promising new solution.

The most common approach for white light generation relies on a combination of blue LED light and excited emission from one or more phosphor materials. This approach is still a big challenge when it comes to fulfilling the requirements for white light quality, for example, keeping the chromaticity coordinates of a single LED light source constant during operation and lifetime. Current approaches to solve this problem typically rely on a readjustment of the chromaticity coordinates by means of sensors and drivers technologies. This reduces the energy efficiency, increases the size and cost of the light sources, and decreases long-term reliability.

Recently, we suggested that it might be possible to compensate temperature

induced impacts on the color temperature constancy, as they may occur for different operational conditions, to some extent without additional sensors and drivers: namely simply by using a sophisticated composition of the materials used in the color conversion element (CCE), which typically consists of the phosphor particles embedded in a silicone matrix. In fact, materials with appropriate optical properties can be combined in order to compensate opposite color shifts when, for example, the temperature in the device is increased and the quantum efficiency of the phosphor is reduced. One approach in this regard relies on the use of materials with suitable thermo-optic coefficients.

Introduction

Although the phenomenon of electroluminescence has been known for more than 100 years [1,2], it took until the early 1990s for efficient blue LEDs, which are the core elements for solid-state lighting (SSL), to become available. From that time on, a great amount of worldwide industrial and academic research activities resulted in rapid enhancement of both device performance and life time, which resulted in solid state lighting sources replacing traditional ones for more and more applications [3, 4]. Nonetheless, as noted, estimates are that SSL has only reached the halfway point in terms of lighting efficiency, which leaves a lot of challenges ahead. Not only in terms of energy efficiency, but also for color quality and control, as well as other advantages that remain largely untapped [5].

The color variation among individual LEDs should be in the order of a 2-step MacAdam ellipse [6] for white LEDs to be accepted for general lighting. There are several reasons why it is hard to meet this demand with today's most common approach for white LEDs that relies on color conversion by a phosphor. This phosphor is part of the color conversion element (CCE) that typically consists of phosphor particles embedded in a silicone matrix. While this concept seems to be rather trivial, recent studies have shown that the performance of phosphor converted LEDs in terms of light output and white light quality also critically depends on the shape, composition and arrangement of such CCEs within the LED package [7 - 10].

Moreover, phosphors generally face the problem of decreasing luminescence intensity with increasing temperature. Thus, the contribution of the phosphor emission to the overall emission spectrum decreases with temperature, which severely affects the color temperature constancy of phosphor converted LEDs under operation, in particular when the driving current is varied. In a recent publication, based on optical simulations using a reference LED system consisting of an LED die and a conceptual simple CCE with a square shape and a flat surface, we have shown that a reduction of the quantum efficiency of the phosphor by about 6 % would result in a color deviation matching the outer limits of a MacAdam ellipse in step 2 [11]. For practical applications this value should be much smaller in order to give leeway to the other potential sources for color deviation that will add up to the final color shift.

Although recent progress in materials synthesis brought about much progress in new phosphors with lower temperature dependencies of luminescence quenching, it will be very difficult to maintain color variations within the above mentioned tolerance ranges,

in particular since the temperatures within the CCE may become considerably high under operation [12 - 14]. Thus, it is insufficient to restrict strategies to diminish temperature induced color shifts simply to progress further in phosphor development. On the other hand, current approaches to solve this problem typically rely on a readjustment of the chromaticity coordinates by means of sensors and drivers technologies. This, however, reduces the energy efficiency, and increases the size and cost of the light sources, and decreases long-term reliability.

We recently presented an approach that, in combination with phosphors having a high thermal stability of their luminescence intensities, has the potential to alleviate temperature induced color shifts to a large extent [15]. This approach is based on the thermo-optic coefficients dn/dT of the materials constituting the CCE, in particular that of the phosphor and the silicone matrix. While silicones typically have a comparably large thermo-optic coefficient, phosphors like Ce:YAG, have a much lower one. In addition, as typical for polymers, the thermo-optic coefficient of silicone is negative. This means the refractive index decreases with increasing temperature. Since the refractive index of the silicone matrix material is generally smaller than the one of the phosphors and due to its much larger thermo-optic coefficient, a reduction of the refractive index of silicone will enlarge the differences of the refractive indexes of the silicone and the phosphor with increasing temperature. This will therefore enhance light scattering that is the reason for a more yellowish emission in itself. On the other hand, also the luminescence intensity of the phosphors generally decreases with temperature, which in itself gives reason for a more bluish emission. Adjusting the thermo-optic coefficients of the CCE materials to the respective temperature dependent luminescence, loss of a phosphor can therefore be applied to

counterbalance the corresponding color temperature shift due to the luminescence loss of the phosphor.

In the following we extend these previous studies and show how the use of a multilayer set-up, in which, for example, an additional silicone layer is used for encapsulation can be applied to compensate different values of phosphor luminescence intensity reduction. Therewith, once the temperature dependency of the luminescence intensity reduction of the phosphor is known, an appropriate combination of silicones with different thermo-optic coefficients or different designs can be chosen to counterbalance a color shift. By this, it is not necessary to provide a lot of silicone materials that have exactly the required thermo-optic coefficients that are necessary to compensate the luminescence intensity loss of a given phosphor. The latter can, to some extent, also be achieved by an appropriate combination of given silicones. In addition, this multilayer approach also has the potential to be applied in case the CCE consists of two layers with different phosphor materials. In this case, each layer requires a different thermo-optic coefficient of the silicone in order to counterbalance color shifts induced by the respective luminescence intensity losses of the phosphors.

Simulation

The details of the simulation procedure can be found in a previous publication [7]. Generally, the simulation procedure that was carried out with the commercial software package ASAPTM, relies on the set-up of an appropriate simulation model for a blue emitting LED die and the implementation of a square-shaped CCE with a flat surface on the top of the die (Figure 1 - the simulation models).

Two wavelengths are considered in the simulations: one representing the blue LED light (460 nm) and the other one the converted yellow light (565 nm).

Figure 1: The simulation model consists of a blue emitting LED die with a square-shaped CCE placed on top of it. A second silicone layer mimicking a silicone encapsulation layer consists of either pristine silicone (a) or contains scattering particles with a concentration of 10 vol.% (b)

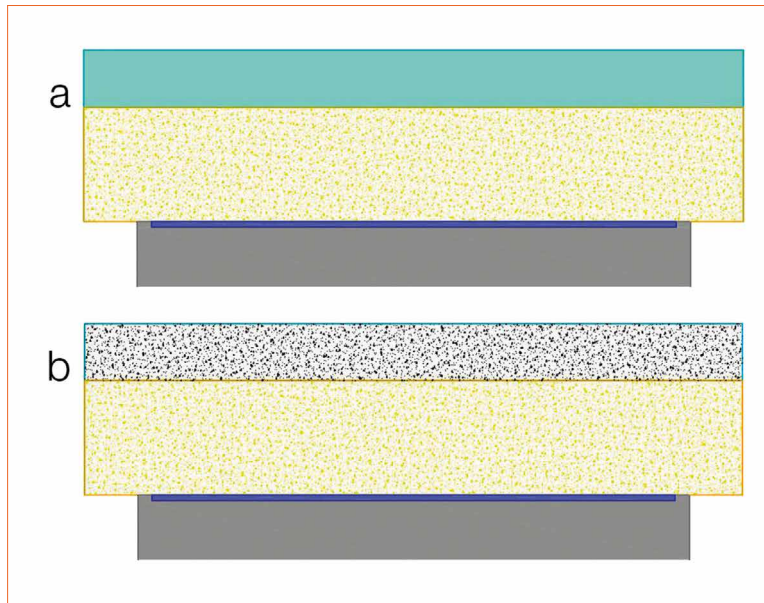

The simulation model consists of a blue emitting LED die with a square-shaped CCE placed on top of it. The blue emitting LED die consists of an emitting area with dimensions of $940\ \mu\text{m} \times 940\ \mu\text{m}$ and gold pads for wire bonding in two neighboring corners that are placed on top of a silicon substrate. The silicon substrate has dimensions of $990\ \mu\text{m} \times 990\ \mu\text{m}$ and a height of $100\ \mu\text{m}$ and is placed on a printed circuit board by COB technology. The CCE has a width of $1040\ \mu\text{m} \times 1040\ \mu\text{m}$ and a height of $400\ \mu\text{m}$. The concentration of the phosphor particles in the silicone matrix is 10 vol.%. A second silicone layer with a height of $200\ \mu\text{m}$ is placed on top of the CCE, mimicking a silicone encapsulation layer. This encapsulation layer consists of either pristine silicone or contains scattering particles with a concentration of 10 vol.%.

It is assumed that only the blue LED light is absorbed by the yellow phosphor particles. Therefore the extinction coefficient of the yellow phosphor particles is set to zero for $565\ \text{nm}$ and to 1×10^{-3} for $\lambda = 460\ \text{nm}$. Both the blue LED light and the yellow converted light are scattered throughout the CCE. The simulation of this scattering process is based on the scattering model of Mie and considers the particle size distribution of the phosphor and the optical properties of both the matrix

material and the phosphor. While the refractive index of the phosphor is kept constant throughout this study at $n = 1.63$, that of the silicone is varied in between $n = 1.4$ (for the reference system) and $n = 1.35$. The quantum efficiency values of the phosphor are varied between 100% (for the reference system) and 90%. The mean diameter of the phosphor particles is kept constant at $7.8\ \mu\text{m}$ with a standard deviation of $4.2\ \mu\text{m}$.

The encapsulation layer consists of either pristine silicone (with the same optical properties as the silicone used as a matrix material for the CCE) or contains scattering particles (with the same (optical) properties as the phosphor particles, apart from an extinction coefficient of zero also for $\lambda = 460\ \text{nm}$). This encapsulation layer has the same lateral dimensions as the CCE and a height of $200\ \mu\text{m}$ (Figure 1).

The thermal simulations were performed as discussed more in detail in Reference 12. In order to gain detailed information on the absorption profile of the blue LED light within the CCE, the latter is divided into a number of voxels (100 columns of voxels in vertical direction for the reference system, each column consisting of 260×260 voxels in lateral directions). From the ray-tracing simulations the absolute number of the blue radiant flux which is absorbed by each of the

individual voxels can be determined from the respective overall blue radiant flux for a specific current as determined from the data sheet, in this case, of a Cree EZ 1000 (Gen I) LED chip [12].

For the subsequent thermal simulations three-dimensional models of the LED package were set-up using the GPL-software packages GetDP/Gmsh. In this case, the CCE is modelled as a block with specific thermal conductivity and heat capacity. The bottom surface of the printed circuit board is assumed to be mounted on a perfect cooler, which realizes a constant temperature T_{cool} (Dirichlet boundary condition) at the bottom surface, for which a temperature of $300\ \text{K}$ has been chosen. All other boundaries of the model are subject to natural air convection for which a value of $h = 20\ \text{W}/(\text{m}^2 \cdot \text{K})$ and an ambient temperature of $300\ \text{K}$ were selected.

Results and Discussion

Besides their use in phosphor converted LEDs, silicones are attractive for a lot of photonic devices, like waveguide material in telecom applications [16]. Their refractive indexes and their thermo-optic coefficients dn/dT can be adjusted by the choice of the respective side-groups and the cross linking density [16]. Thereby, the latter parameter can be adjusted in between values of about $-1.5 \times 10^{-4}\ \text{K}^{-1}$ and $-5 \times 10^{-4}\ \text{K}^{-1}$ [16, 17]. For example, for dimethylsiloxane a thermo-optic coefficient of $-5 \times 10^{-4}\ \text{K}^{-1}$ was reported for bulk samples, while methyl-phenyl-siloxane has one of $-3.8 \times 10^{-4}\ \text{K}^{-1}$ [16]. On the other hand, the thermo-optic coefficients of phosphors are comparably small. For instance, for Ce:YAG a value of $7.8 \times 10^{-6}\ \text{K}^{-1}$ [18] is reported, which is typical for YAG based systems [19] and which is almost two orders of magnitudes smaller than that of silicone. Therefore, in a first approximation, in this study the thermo-optic coefficient of the phosphor can be neglected with respect to that of the silicone.

The relevance for a compensation of temperature induced color shifts is highlighted in figure 2, which shows line scans for the temperature profiles along the vertical direction of the LED package assuming that the assembly is mounted on a cooler with a constant temperature of 300 K, the quantum efficiency of the phosphor is either 70% or 100% and that the LED package is operated at either 350 mA or 1000 mA. The LED die is placed on a printed circuit board (PCB) by chip-on-board technology with an adhesive layer having a height of 10 μm . The PCB consists of an aluminum substrate with a height of 1500 μm and a dielectric layer (80 μm) as well as a copper layer (70 μm) on its top. At the assembly's bottom face (outside the size range shown in figure 2) Dirichlet boundary conditions are considered. All other boundaries of the model are subject to natural air convection. In any

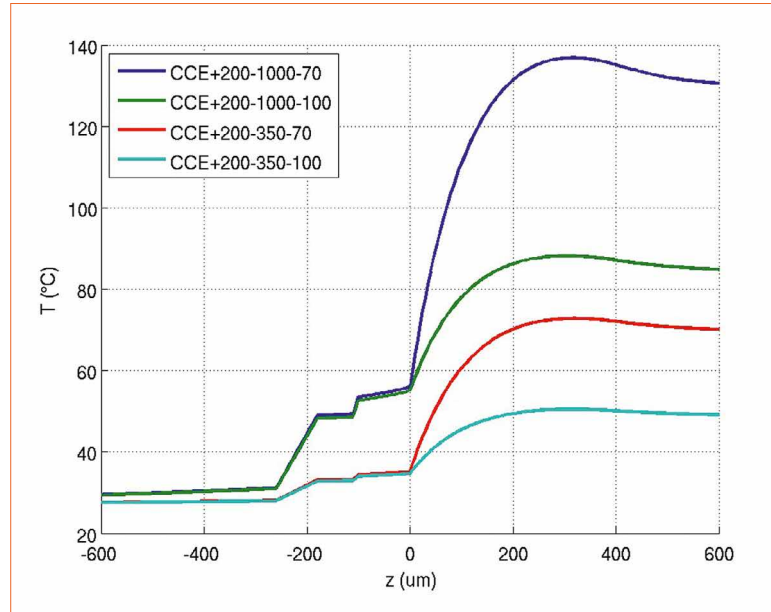

Figure 2: Line scans for the temperature profiles along the vertical direction of the LED package

case, the highest package temperatures are located within the CCE. Bearing in mind that, as recently discussed, a temperature variation of about 40 K (in particular at higher temperature levels) might

be just tolerable for CCT variations which do not exceed a MacAdam ellipse of step 2 [11] it is obvious that a compensation of temperature induced color variations is indispensable.

PHOTONICS FESTIVAL in TAIWAN



LED Lighting Taiwan

The 11th Int'l LED Lighting Exposition
www.optotaiwan.com

June 16-18, 2015

TWTC Nangang Exhibition Hall

UV LED / IR LED Special Zone



A The development of new LED business patterns

The new blue ocean market for LED: UV LED, IR LED, Proof lights, jointly demonstrated in special zones



B Total Solution @ One-stop shop in "Photonics Taiwan"

Cross-industry platform, promotion and integration of energy-saving services, finding best partners in Taiwan



C Most update market trends

International forums, IOA meeting, new technical publications to disclose comprehensive market trends and new technologies

Exhibits

■ **LED / OLED Light Source, Package / Module/ Engine**
LED Epi Wafer / Chip, OLED Components, LED Package, LED Module / Engine, OLED Module / Engine

■ **LED / OLED Lighting Fixture**
Technical Lighting
Decorative Lighting
Accessories and Electronic Components

■ **LED Applications**
Backlight, Automobile, Display Board
Traffic Signal, Projector, IrDA,
IR / UV Lights
Others

■ **LED / OLED Materials**
LED Materials, OLED Materials
■ **LED / OLED Equipment**
LED Equipment
OLED Equipment



Photonics Industry & Technology
Development Association

【Contact】 Tel : +886-2-2351-4026
Fax : +886-2-2396-8513

David Heh (ext. 254)
E-mail : david.heh@mail.pida.org.tw



Figure 3: Variation of CIE x values as a function of the quantum efficiency of the phosphor and the refractive index of the silicone for a set-up in accordance with figure 1a

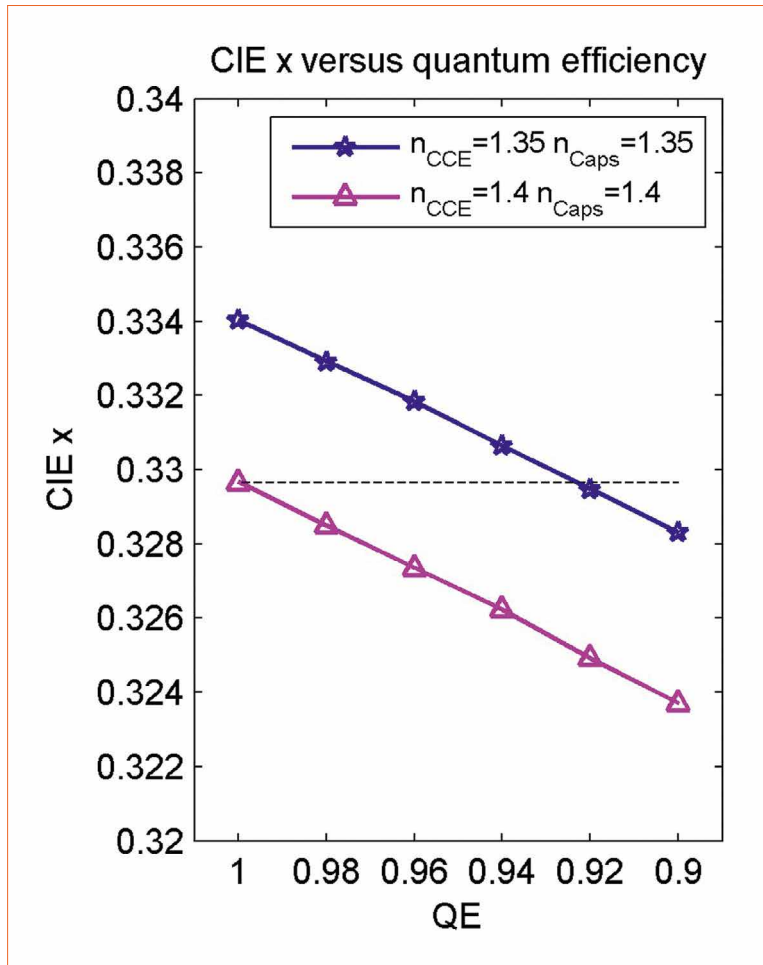

Figure 3 shows the variation of the CIE x values as a function of the quantum efficiency of the phosphor and the refractive index of the silicone for a set-up in accordance with figure 1 a. In this case, the silicone (both for the CCE and the encapsulation layer) is assumed to have a thermo-optic coefficient of $-5 \times 10^{-4} \text{ K}^{-1}$. The figure shows the variation of the CIE x values at room temperature ($n = 1.4$) with respect to a decreasing quantum efficiency of the phosphor. In addition, the figure also shows the variations of the CIE x values for the same reductions of the quantum efficiency values, assuming a refractive index of the silicone of 1.35. Latter value represents, in accordance with the thermo-optic coefficient, the refractive index of the system for a temperature that is 100 K higher than the room temperature. Due to the enhanced light scattering, a refractive index of 1.35 gives reason for higher CIE x values, despite a reduction of the quantum efficiency. Still, due to the additional silicone layer, all CIE x values are a little bit

lower than those presented in our previous study for the CCE without an additional silicone encapsulation layer [15].

As already mentioned above, such a temperature dependent reduction of the refractive index of the silicone will increase the refractive index difference between the phosphor and the silicone. This will enhance light scattering and is the reason for a more yellowish emission. By itself, this would therefore give reason for some color deviation to the yellowish upon device operation. On the other hand, with increasing temperatures in the CCE, the luminescence intensity of the phosphor will simultaneously decrease. Such a temperature dependent reduction of the luminescence intensity of the phosphor gives reason for a more bluish emission. This means, that by an appropriate matching of the temperature induced luminescence loss of the phosphor and the respective thermo-optic coefficient of the silicone, which

have a contrarian temperature dependent effect on the color shift, both effects can be counterbalanced, at least in those temperature ranges, for which the slope of the intensity loss of the phosphor does not become too strong.

As shown, in comparison with the reference system at room temperature, at a 100 K higher temperature, a silicone with a thermo-optic coefficient of $5 \times 10^{-4} \text{ K}^{-1}$ and a quantum efficiency value of the phosphor of a little bit more than 92% again results in almost the same CIE x value as the initial system at room temperature. This means that such a thermo-optic coefficient of the silicone in principle can counterbalance about an 8 % reduction of the quantum efficiency value in the temperature range of 100 K for the given set-up.

Figure 4 shows the same dependencies as in case of figure 3. But with respect to the set-up shown in figure 1 b, for which additionally scattering particles are added to the silicone encapsulation layer. The CCE consists of a silicone having a thermo-optic coefficient of $-5 \times 10^{-4} \text{ K}^{-1}$. The additional silicone encapsulation layer on top of the CCE has the same refractive index and the same thermo-optic coefficient as the silicone used as a matrix for the CCE. The encapsulation layer is filled with 10 vol. % scattering particles. Assuming a refractive index of the silicone of 1.4 and a quantum efficiency of the phosphor of 100% at room temperature, a reduction of the quantum efficiency by more than 8% can be compensated at a 100 K higher temperature. Due to the additional scattering of the light induced by the scattering particles, and in particular due to some back scattering of blue light, which now impinges upon the phosphor particles, the overall emission becomes more yellowish and also slightly higher values of luminescence intensity reduction can be compensated.

Figure 5 shows a combination of silicones with different thermo-optic coefficients, in which it is assumed that either the CCE or the encapsulation layer silicones have thermo-optic coefficients of either $-1.5 \times 10^{-4} \text{ K}^{-1}$ or $-5 \times 10^{-4} \text{ K}^{-1}$ (which coincides, as discussed above, with the possible range of thermo-optic coefficients of silicones). In addition, the encapsulation layer is filled with scattering particles (10 vol. %). The figure shows that different quantum efficiency losses can be compensated in this way. Assuming that the silicone of the CCE has a comparably low thermo-optic coefficient and the encapsulation layer a larger one, a comparably small reduction of the quantum efficiency can be compensated, while in the other case a much larger one can be compensated. Assuming a refractive index of the silicone of 1.4 and a quantum efficiency of the phosphor of 100% at room temperature, different values for temperature dependent luminescence intensity losses of the phosphor can be compensated at a 100 K higher temperature. In addition, a comparison of the cases shown in figure 3 (both layers have a refractive index of 1.35 at a 100 K higher temperature) and figure 4 shows that by such an approach additional values for a possible quantum efficiency loss (as it is determined by a specific phosphor) can be compensated or at least be best fitted to the function for the temperature dependent quantum efficiency loss.

Conclusion

Besides the necessity to consider the thermo-optic coefficients of the materials constituting the CCEs of phosphor converted LEDs for color constancy of phosphor converted LEDs under operation in general, an appropriate adjustment of the thermo-optic coefficients also opens the possibility to accurately counterbalance the temperature dependent luminescence loss of a specific phosphor, at least for a specific temperature range.

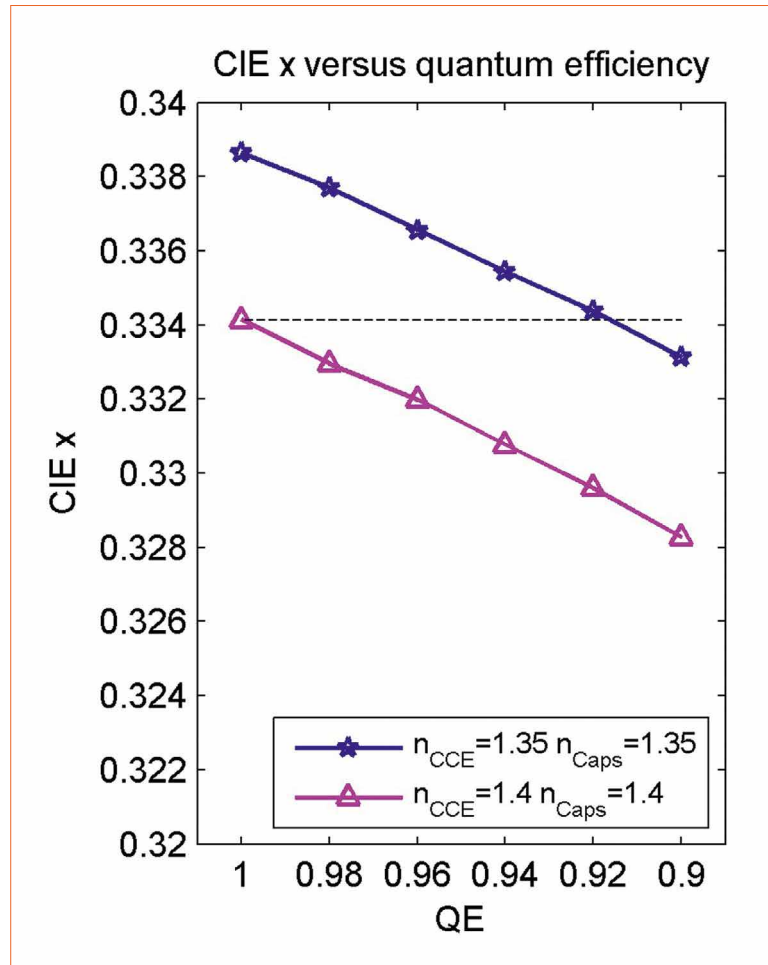

Figure 4: Variation of CIE x values as a function of the quantum efficiency of the phosphor and the refractive index of the silicone for a set-up in accordance with figure 1b for which additionally scattering particles are added to the silicone encapsulation layer

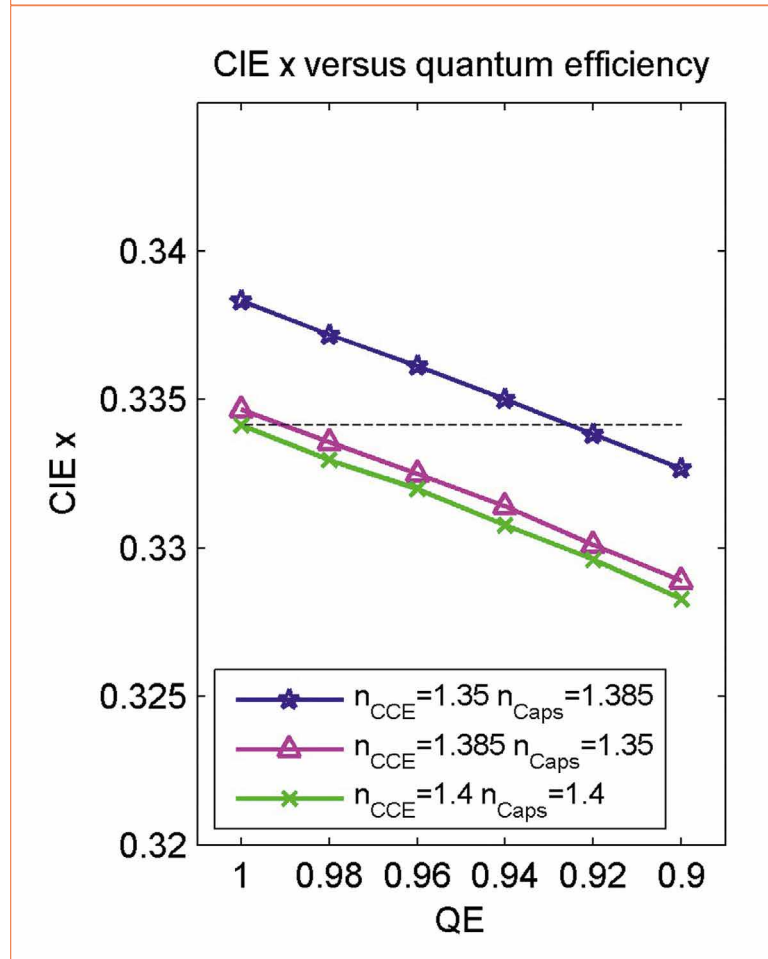

Figure 5: Variation of CIE x values as a function of the quantum efficiency of the phosphor and the refractive index of the silicone for a combination of silicones with different thermo-optic coefficients

Thus, besides research on new phosphor materials with higher thermal stabilities in order to reduce the temperature dependent color shift upon device operation, research activities should also focus on matrix materials development with regard to their thermo-optic coefficients. The capability of being able to adjust the thermo-optic coefficient with high precision is of particular importance since, as shown, even small variations of the thermo-optic coefficient again may have a notable impact on color temperature constancy. On the other hand, as shown in the present study, an appropriate combination

of two layers of silicones with different thermo-optic coefficients (and/or filling them with different concentrations of scattering particles) can be applied to counterbalance several different levels of temperature induced color variations due to luminescence intensity reduction, which provides an alternative to the synthesis of a lot of different silicones, each of them having a different thermo-optic coefficient.

In addition, such a multilayer approach also has a high potential to be applied in case the CCE consists of two layers with different

phosphor materials in order to improve color rendering. For such an attempt it has been shown that a two-layer approach is favorable with respect to mixing both phosphors into one silicone layer [20]. In this case each layer will require a different thermo-optic coefficient of the silicone in order to counterbalance color shifts induced by the respective temperature dependent luminescence intensity losses of the phosphors. ■

Acknowledgement:

The authors gratefully acknowledge financial support by the Klima- und Energiefonds (KLIEN) and the Österr. Forschungsförderungsgesellschaft mbH (FFG), project no. 843877, iCol.

References:

- [1] H. J. Round, H. J. "A note on carborundum", *Electrical World* 49: 309, (1907)
- [2] N. Zheludev, "The life and times of the LED — a 100-year history", *Nature Photon.* 1, 189, (2007)
- [3] M. H. Crawford, "LEDs for solid-state lighting: performance challenges and recent advances". *IEEE J. Sel. Top. Quantum Electron.* 15, 1028 – 1040, (2009)
- [4] E. F. Schubert and J. K. Kim, "Solid-state light sources getting smart", *Science* 308, 1274 - 1278, (2005)
- [5] J. Brodrick, http://apps1.eere.energy.gov/buildings/publications/pdfs/ssl/feb2013_nema_brodrick.pdf
- [6] N. Narendran, L. Deng, R. M. Pysar, Y. Gu, and H. Yu, "Performance characteristics of high-power light-emitting diodes, *Proc. of SPIE vol.* 5187, 267, (2004)
- [7] C. Sommer, P. Hartmann, P. Pachler, M. Schweighart, S. Tasch, G. Leising, F. P. Wenzl: "A detailed study on the requirements for angular homogeneity of phosphor converted high power white LED light sources"; *Opt. Mater.* 31, 837 - 848, (2009)
- [8] Z.-Y. Liu, C. Li, B.-H. Yu, Y.-H. Wang, H.-B. Niu, „Effects of YAG:Ce phosphor particle size on luminous flux and angular color uniformity of phosphor-converted white LEDs“, *IEEE/OSA J. Disp. Technol.* 8, 329 - 335, (2012)
- [9] C.-C. Sun, C.-Y. Chen, C.-C. Chen, C.-Y. Chiu, Y.-N. Peng, Y.-H. Wang, T.-H. Yang, T.-Y. Chung, C.-Y. Chung, "High uniformity in angular correlated-color-temperature distribution of white LEDs from 2800K to 6500K, *Opt. Express* 20, 6622 – 6630, (2012)
- [10] R. Hu, X. Luo, H. Feng, S. Liu, „Effect of phosphor settling on the optical performance of phosphor-converted white light-emitting diode“, *J. Lumin.* 132, 1252 - 12156, (2012)
- [11] C. Sommer, P. Hartmann, P. Pachler, H. Hoschopf, F. P. Wenzl, „White light quality of phosphor converted light-emitting diodes: A phosphor materials perspective of view“, *J. Alloys Compd.* 520, 146 - 152, (2012)
- [12] P. Fulmek, C. Sommer, P. Hartmann, P. Pachler, H. Hoschopf, G. Langer, J. Nicolics, F. P. Wenzl, "On the thermal load of the color conversion elements of phosphor based white light emitting diodes", *Adv. Opt. Mater.* 1, 753–762, (2013)
- [13] X. B. Luo, X. Fu, F. Chen, H. Zheng, "Phosphor self-heating in phosphor converted light emitting diode packaging", *Inter. J. Heat .Mass Transfer*, 58, 276 - 281, (2013)
- [14] F. P. Wenzl, C. Sommer, P. Hartmann, P. Pachler, H. Hoschopf, G. Langer, P. Fulmek, J. Nicolics, The impact of the non-linearity of the radiant flux on the thermal load of the color conversion elements in phosphor converted LEDs under different current driving schemes, *Opt. Express* 21, A439 – A449, (2013)
- [15] S. Schweitzer, C. Sommer, P. Hartmann, P. Pachler, H. Hoschopf, F. P. Wenzl, "Improvement of color temperature constancy of phosphor converted LEDs by adaption of the thermo-optic coefficients of the color conversion materials", *IEEE/OSA J. Disp. Technol.* 9, 413 – 418, (2013)
- [16] E. Vanlathem, A. W. Norris, M. Bahadur, J. DeGroot, M. Yoshitake, "Novel silicone materials for LED packaging and opto-electronic devices", *Proc. of SPIE* 6192, 619202, (2006)
- [17] K. Su, J. V. Degroot, A. W. Norris, P. Y. Lo, "Siloxane materials for optical applications", *Proc. of SPIE* 6029, 60291C, (2005)
- [18] <http://www.scientificmaterials.com/products/ce-yag.php>
- [19] R. Wynne, J. L. Daneu, T. Y. Fan, „Thermal coefficients of the expansion and refractive index in YAG“, *Appl. Opt.* 38, 3282 - 3284, (1999)
- [20] J. P. You, N. T. Tran, F. G. Shi, Light extraction enhanced white light-emitting diodes with multi-layered phosphor configuration, *Opt. Express* 18, 5055 – 5060, (2010)

guangzhou international lighting exhibition

广州国际照明展览会



**The most influential and comprehensive lighting
and LED event in Asia**

9 – 12 June 2015

China Import and Export Fair Complex
Guangzhou, China

www.light.messefrankfurt.com.cn

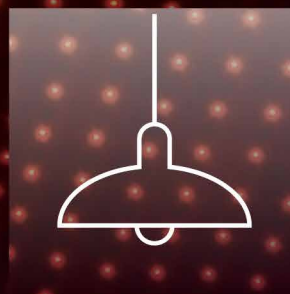
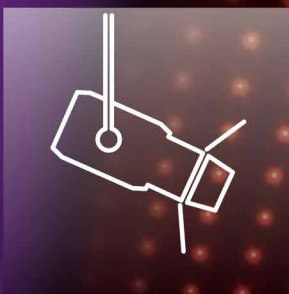
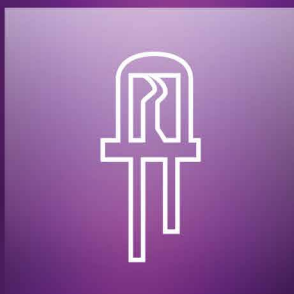
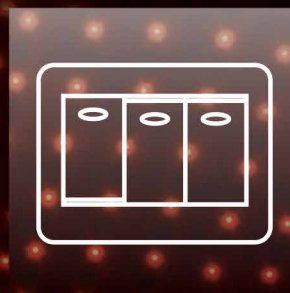
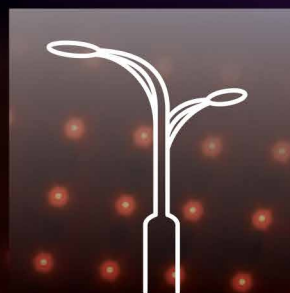

Contact

Messe Frankfurt (HK) Ltd

Tel: +852 2238 9969

Fax: +852 2519 6079

light@china.messefrankfurt.com



 **光亞 · Guang ya**

 **messe frankfurt**

3-Pad LED Flip Chip COB

Wafer level packaging and flip chip design are the most recent trends in LED manufacturing and packaging. These LED types are perfectly suited for producing COB modules. This combination already promises better thermal performance than standard SMD package based products. However, there is still room for improvements. Pao Chen, Director of Research and Development at Flip Chip Opto shows how a 3-pad flip chip LED further reduces thermal resistance, allows higher power and can help to reduce costs.

Recent development of the LED Chip on Board (COB) module with LED flip chips has successfully demonstrated its advantage in having lower thermal resistance and cheaper packaging costs over the conventional wire-bond LED COB. By lowering the thermal resistance, LED chips are able to perform with lower junction temperatures and have less thermal decay while thermal dissipation is enhanced. Meanwhile, lower thermal resistance also enables the feasibility to increase optical output through the higher driving current.

Comparison of COB Designs

Figure 1(a) and 1(b) show the schematic diagrams of a wire-bond COB and a conventional flip chip COB, respectively. In figure 1a, a lateral LED chip is bonded on the metal core printed circuit board (MCPCB) substrate by bonding epoxy and connects to the circuit electrodes via two bonding wires. The thermal energy generated by the LED chip is dissipated through the chips' sapphire substrate, bonding epoxy, followed by a MCPCB dielectric layer before reaching the metal core. On the other hand, a conventional flip chip COB shown in figure 1b has the LED chip directly bonded on the circuit electrodes without the bonding wire and epoxy. The heat generated by

the LED is coupled through the chip bonding pads, circuit electrodes, MCPCB dielectric layer, and then diffused into the metal core. In comparison, the conventional flip chip COB exhibits less thermal resistance as its thermal dissipating path excludes the sapphire substrate and bonding epoxy that are materials having higher thermal resistance. In addition, the packaging cost is reduced without bonding wires and their associated bonding processes. The optical output is also improved without the wire-bonding spots that occupy a partial section of the lighting surface. Meanwhile, some COBs employ ceramic substrate to replace MCPCB for its dielectric character and better thermal conductivity.

Figure 1: Structural diagrams of (a) a wire-bond COB, (b) a conventional flip chip COB, and (c) a 3-Pad LED flip chip COB

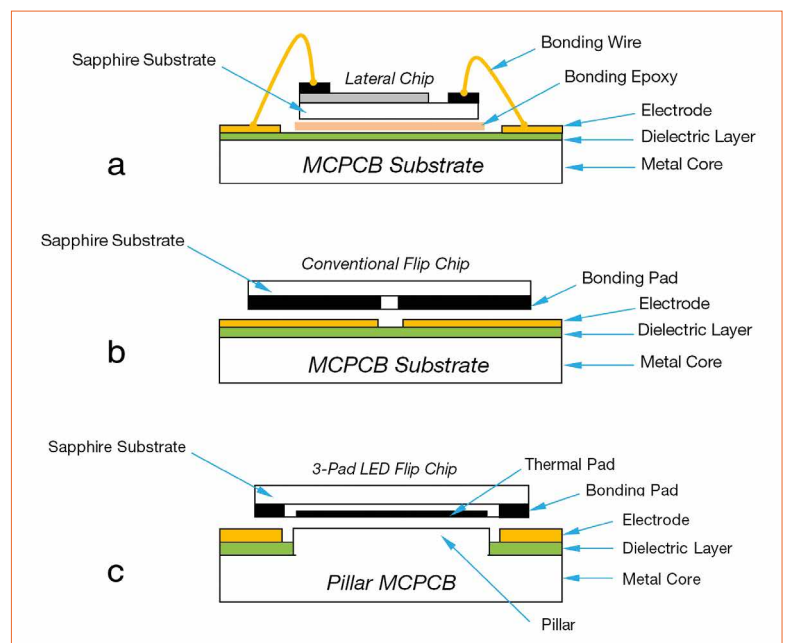

However, the applications of ceramic-based COB are always restricted due to ceramic's relatively higher cost and manufacturing limits over the physical size and shape.

3-Pad LED flip chip COB shown in figure 1c is a novel innovation to further reduce the COB thermal resistance, and enable the brightness boost for best lumen-per-dollar performance. The 3-Pad LED flip chip consists of a third contact pad, known as the thermal pad that is electrically isolated and positioned between the N- and P- electrode pads. The thermal pad is designed as a thermal coupling window to optimize the thermal dissipation from the LED's junction to MCPCB's pillar structure, which appears as an extension of the metal core inside the MCPCB. This arrangement ensures that the entire thermal dissipating path is constructed with highly thermal conductive materials, e.g., metal, alloy, solder, and therefore the thermal resistance between the LED junction and COB bottom is further reduced to minimize the thermal decay.

Thermal Behavior Comparison

Thermal decay is a natural characteristic for LED, as the optical output decreases when the LED junction temperature is increased. Therefore, the lighting efficacy would decrease following the increase of the LED junction temperature while the driving current is increased. In order to minimize the thermal decay, lowering the thermal resistance becomes essential to maintain or lower the LED junction temperature while more optical output is demanded through the increase of driving current. Figure 2 shows the magnitude of efficacy decay measured from a wire-bond ceramic COB and a 3-Pad LED flip chip COB, and their decay results are represented by the red and blue curves respectively. Both COBs were chosen based on their similar overall power consumption and

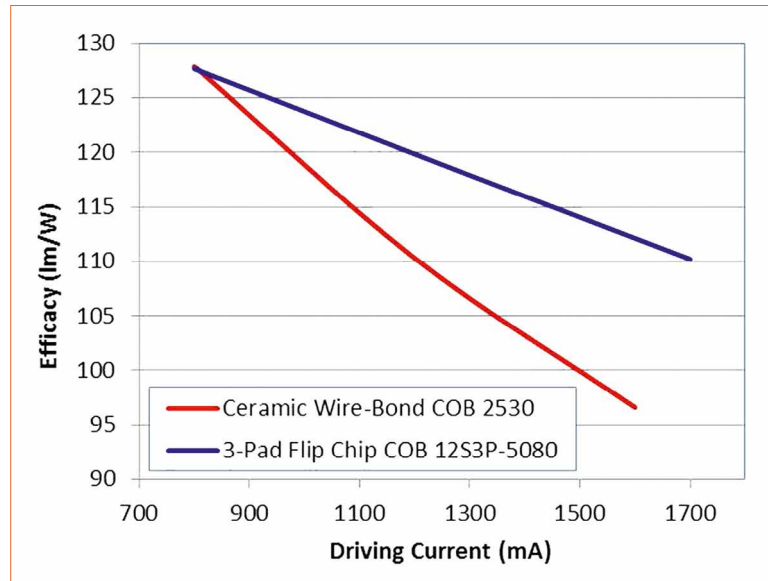

Figure 2: A comparison of thermal decay presented by the efficacy decline varying with increasing driving current between a 3-Pad flip chip COB and a ceramic based wire-bond COB

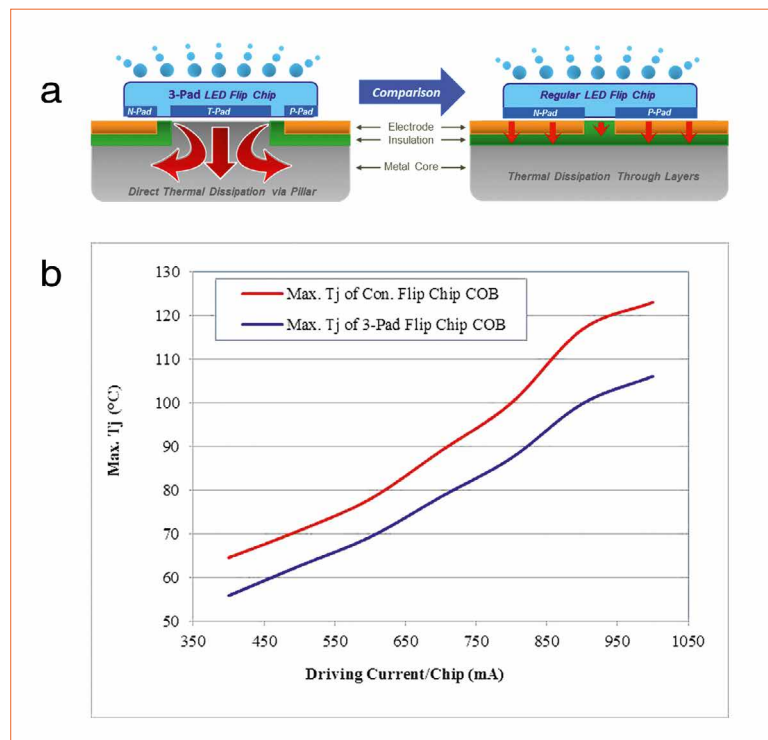
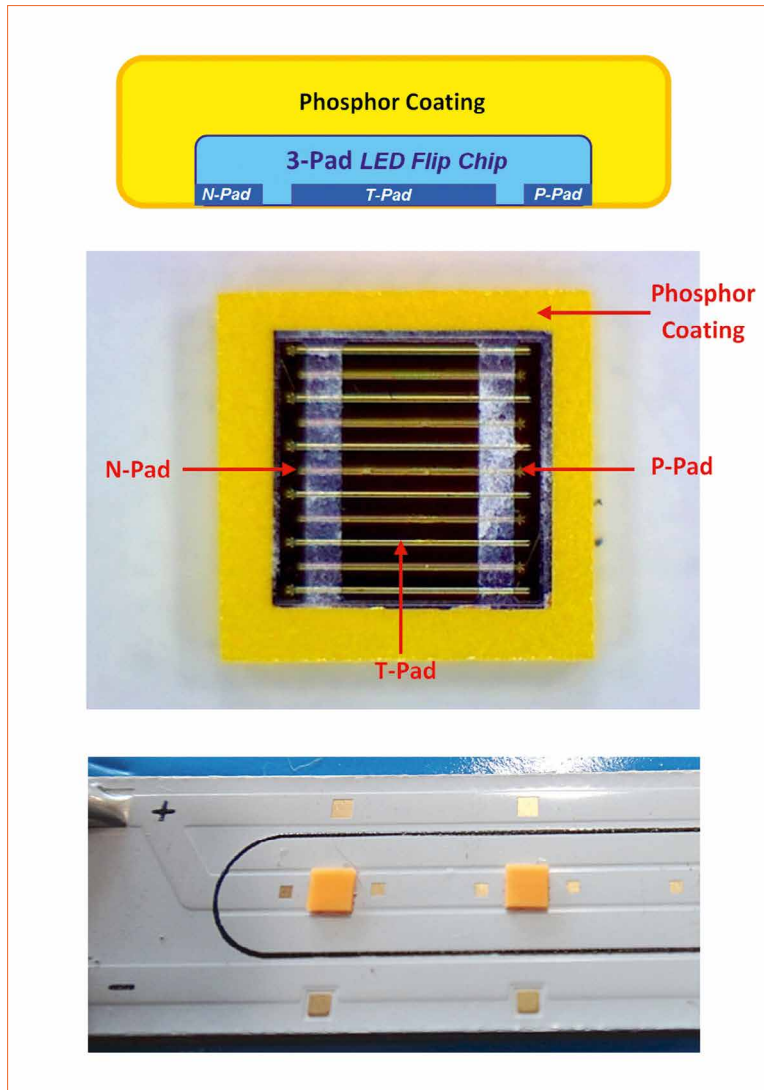

Figure 3: (a) Structural diagrams indicating the difference of thermal dissipation between a 3-Pad LED flip chip COB at left and a conventional flip chip COB at right. (b) The maximal junction temperature measured varying with increasing driving current between the 3-Pad LED flip chip COB on the left and a conventional flip chip COB on the right

performance specifications of 5000 K CCT and 80 CRI. By comparing the efficacy decay exhibited by both COBs, the decay rate of the 3-Pad LED flip chip COB is roughly about 50% less than the wire-bond ceramic COB. For instance, at 50 W ($I = 1.3$ A) operation, the 3-Pad LED flip chip COB is able to output 550 more lumen than the ceramic wire-bond COB does due to its lesser efficacy decay. This result highlights the significance of low thermal resistance in maintaining the lighting efficacy while a high driving current is applied for more lighting output.

A measurement of LED junction temperature varying with driving current is conducted to evaluate the capability of brightness boost from a 3-Pad LED flip chip COB and a conventional flip chip COB, (Figure 3a). They are fabricated in the same mechanical dimension (18x18x1 mm) and of the same materials including copper substrate, dielectric layer and circuit trace. Both COBs are mounted on two identical heat sinks during the characterization and each of them consists of twelve 45 mils by 45 mils LED flip chips in series within a Light Emitting Surface (LES) of 12 mm diameter.

Figure 4:
 (a) A structural diagram of a 3-Pad Chip Scale Package; (b) bottom view of a 3-Pad Chip Scale Package; (c) a light bar COB having 3-Pad Chip Scale Packages on its surface



Phosphor Deposition for CSPs

Typical flip chip COBs are fabricated by dispensing the phosphor epoxy to cover the flip chips that have been bonded onto the MCPCB or ceramic surfaces. An emerging LED flip chip, known as Chip Scale Package (CSP) or White Chip, takes an elegant route to alter the COB manufacture processes. Structure-wise, CSP is a LED flip chip with phosphor materials surrounding all five facets except for the one with contact pads (Figure 4a). This approach simplifies the COB manufacturing process without the involvement of dispensing the phosphor epoxy, and takes control of the performance parameters into the chip level instead of the post bonding processes.

The phosphor deposition for the CSP can be conducted either directly onto the LED wafer before dicing, or around each individual chip, or onto the post bonding package via deposition methods such as coating, screen printing, spray deposition, immersion and film lamination. Although those deposition methods are standard in solid state processes, they do share several challenges during phosphor deposition, such as reliability, adhesion strength, radiation pattern control, and color uniformity that is influenced by the thickness of the phosphor layer and the aligning accuracy with flip chips. On the packaging side, COB bonding also needs to overcome issues existing between the CSPs and MCPCB, such as accuracy of bonding alignment, strength against shear force and chemical protection.

Figure 4b shows the bottom view of a 3-Pad CSP reflecting on the structural diagram in figure 4a, and figure 4c displays a light bar COB having 3-Pad CSPs as its illuminating source. The low thermal resistance exhibited by the 3-Pad LED flip chip is able to maintain phosphor's performance by reducing the contact temperature between the chip and phosphor coating. In principle, each CSP is

This characterization is programmed to record the maximal junction temperature at each 100 mA increment under thermal equilibrant condition, and stop when the maximal junction temperature of any COB reaches 125°C. In figure 3b, the maximal junction temperature measured from the 3-Pad LED flip chip COB (blue) and the conventional flip chip COB (red) are displayed. The difference between two curves starts with 9°C at 400 mA per chip and continues to grow with increasing driving current until the maximal junction temperature of the conventional flip chip COB has reached 123°C at 1000 mA per chip. At this point, the temperature gap has expanded to 17°C. It should be noted that the temperature differential between two COBs reaches 11°C when the driving current is at 700 mA. This indicates that the 3-Pad LED flip chip COB

owns at least 100% more of the life span than the conventional flip chip COB when the driving current exceeds 700 mA, and even longer than that of the wire-bond COB.

Assuming that this experimental setup represents a LED luminaire which is limited to the maximal junction temperature at 105°C, the maximal driving current of the conventional flip chip COB is then restricted to 830 mA, whereas the maximal driving current for 3-Pad LED flip chip COB is 970mA. The 3-Pad LED flip chip COB is able to withstand 17% more of the driving current than the conventional flip chip COB, and therefore generates at least 12% more of the optical output. Such capability allows illumination designers to utilize fewer LED chips and smaller optics in the luminaire to achieve the desired brightness.

able to perform independently as a single lighting source of desired spectrum, and also adapts the processes of COB packaging to have the advantages that lower thermal resistance could induce.

Capabilities of 3-Pad LED Flip Chip COBs

3-Pad LED flip chip COB is a proven technology that enables the LED lighting module to output more optical power through its extremely lower thermal resistance. For instance, a 3-Pad LED flip chip COB with 0.007°C/W thermal

resistance is able to output 87,850 lumens from an array of 285 LED flip chips within an LES of 85 mm diameter. The advanced photon density provides illumination designers the flexibility to design the luminaire with smaller LES and optics. In addition, lower thermal resistance also allows the deployment of inexpensive thermal solutions, such as smaller heat sinks, higher thermal resistant heat sinks, economical thermal interface materials (TIM), and at the same time maintaining the LED junction temperature within its safe range.

Conclusions

Consequently, the 3-Pad LED flip chip COB has demonstrated its capability to optimize a luminaire's lumen-per-dollar value through the approaches such as enhanced optical output and usage of smaller heat sinks, smaller optics and fewer LED chips. Meanwhile, the material saving by utilizing smaller heat sinks, smaller optics and fewer chips also helps to preserve the earth's non-renewable resources. ■

led&lighting
exhibition

11th INTERNATIONAL LED SYSTEMS, TECHNOLOGIES,
APPLICATIONS & LED LIGHTING EXHIBITION
OCTOBER 1st-4th, 2015 istanbul expo center (ifm) / turkiye

The ONLY LED and LED Lighting Exhibition of Eurasia

***That all sections of the sector in Turkiye
participate and support***

bigger this year

**with exhibitors from all over the world
and visitors from all buyer countries!**

WE ARE WAITING FOR YOU TOO...



www.marmarafuar.com.tr | T. +90 212 503 32 32 | marmara@marmarafuar.com.tr

Practical Estimation of Materials and Measures for Thermal Management of LEDs

As with all semiconductor devices, LEDs generate heat during operation. They also have a maximum junction temperature specification and exceeding this leads to rapid and usually fatal damage. While LEDs can operate safely at relatively high temperatures there are a number of good reasons why the system thermal design should aim to keep the LEDs as cool as possible. Achieving good thermal properties starts with an appropriate LED package. Giles Humpston, Field Applications Manager at Cambridge Nanotherm, compares solutions for COB based LED packages.

The most obvious reason for keeping LEDs cool is the consequence of failure. While many LEDs are rated at a 50,000-hour lifetime, this is measured and tested within controlled laboratory conditions. In the real world a small proportion of LEDs will fail well before this limit. The chances of this happening are exacerbated by a high operating temperature as this can trigger other failure mechanisms, such as those related to thermal cycling. The consequences of failure of an LED can vary from a small nuisance to a major expense, especially when the man-hour cost of replacement of a luminaire or loss of production in a commercial environment are taken into account.

LED manufacturers carefully test and bin LEDs by wavelength under controlled conditions. The hotter an LED is allowed to operate the greater the possibility it will depart from its allocated bin. With hot LEDs there is then uncertainty of the illumination produced. A recent report published by the US

Department of Energy showed the output from some LED lamps changed markedly if the products were operated at an elevated temperature [1].

Due to reasons of physics, the efficacy of an LED decreases with the operating temperature. This means the light output, expressed as lumens per Watt, declines when LEDs are forced to run hot.

Finally, LEDs are often operated in close proximity to other electronic components that degrade at an elevated temperature. A notable case is electrolytic capacitors, which have a life that is both finite and decreases rapidly at elevated temperatures.

Thus there are multiple incentives to remove heat from LEDs, to obtain maximum economic gain from their deployment and boost overall system reliability.

LED Packaging

LEDs come in essentially three flavors, differentiated by the power rating of the package in which the semiconductor die are sold.

Low-power LEDs

Low-power LEDs are housed in polymeric packages that are soldered to PCBs. Heat transfer is by conduction through the electrical connections of the package into the circuit board. This type of LED usually does not require special attention in terms of thermal management except where multiple LEDs are packed together in a small space. A number of domestic down lighters take this design approach, which can result in as many as 72 SMD3528 devices packed in a 50 mm diameter and consuming 3.5 W.

Medium power LEDs

Medium power LEDs are attached and interconnected on insulating substrates, either singly, or in arrays to form chip-on-board (COB) devices. The LED arrays share a common phosphor, giving this type of LED its "fried egg" nickname. Owing to the thermal dissipation requirement, medium power LEDs

are mounted on a heat sink for their operation; as a rough rule of thumb, LEDs lose around 70% of the electrical power input as heat, and this needs to be removed.

High power LEDs

High power LEDs are also diode arrays but attached to sub-mounts of material that is highly thermally conductive. The primary function of the sub-mount is to act as a heat spreader owing to the power density of this type of device. The sub-mounts are soldered, either singly or in arrays, on thermally conductive PCBs for mounting on heat sinks.

Thermal PCBs for LEDs

Where high brightness LEDs are densely packed into a small form factor, whether for general lighting or for industrial processes such as UV light sources, the thermal power that needs dissipating is often significant, 10's of W/cm². This far outstrips the ability of conventional PCBs to handle. For this and other thermally demanding applications special PCBs are used. There is some confusion and overlap of the generic product names – thermal substrate, insulated metal substrate, metal clad PCB, metal core PCB, metal-in board PCB and many others are used to describe this type of product.

The basic Metal Clad PCB (MCPCB) construction is a base plate of aluminum that acts as the thermal conductor and a top layer of copper that is patterned to match the interconnect requirements of the LEDs. Between them is sandwiched a dielectric to provide the necessary electrical isolation.

Because copper and aluminum are both good thermal conductors and common denominators in all products, what distinguishes the plethora of competing solutions is the construction of the dielectric. In the majority of instances the dielectric is a polymer, often containing a second phase material such as ceramic particles

	Thermal Resistance °Ccm ² /W	= Thickness μm	/ Thermal Conductivity W/mk
*** NANOTHERM*	0.02	10	7
Filled Epoxy	0.13	38	3
Polymide	0.24	17	0.8
FR4	2.5	60	0.25

Figure 1: Thermal resistance of a selection of dielectric materials for thermal PCBs

to boost the thermal conductivity. Depending on the manufacturer of the thermal PCB and its intended use, the thickness of the polymer layer can range from just a few to more than 100 microns in thickness.

Thermal Conductivity, Resistance and Impedance

Manufacturer's datasheets should provide the information to deduce which is the most appropriate thermal management PCB for a given application. Unfortunately they seldom provide the necessary information to permit straightforward comparison between different products, which is not helped by a lack of robustness in the definition of thermal terminology.

Take, for example, the simple metric of the thermal conductivity of the dielectric material. Quoted values for polymer dielectric materials used in thermal PCBs typically range 0.1 – 7 W/mK. Thermal conductivity is a simple material constant that refers to its ability to transfer heat by conduction. While a high number is preferable, what actually matters is the thermal resistance, which is:

Thermal resistance =

$$\frac{\text{Layer thickness}}{\text{Thermal conductivity}}$$

[units °C·cm²/W]

Note that when working with dielectric materials in thermal PCBs, where the layer thickness is typically 10s of microns, the dimension units

of thermal resistance are switched to cm² for ease of handling.

Comparing four dielectric technologies, as in figure 1, seems to imply one solution is better than the others (figures have been rounded).

However, this picture is incomplete. Not only does it fail to provide any information on the thickness of dielectric necessary to achieve a given withstand voltage; it takes no account of the interface resistance between the dielectric material and the metals on both sides.

Interface resistance is a measure of the inability of heat (in the form of electrons and/or phonons) to travel between two materials in physical contact. It is mathematically modeled as a thermal resistance of effectively zero thickness. Unfortunately, and as the manufacturers of thermal interface materials are acutely aware, interface resistance is extremely difficult to predict and often has to be determined by experiment. Almost every physical factor that affects the condition of a surface will have an influence on interface resistance including roughness, porosity, state of oxidation, reflectivity, adsorbed species, pressure, temperature and even time.

Interface resistance is not a negligible parameter and can therefore have a significant impact on the ability of a PCB to transport heat away from LEDs.

The combination of the thermal resistances of all the materials in series in a thermal path, together with all the associated interface resistances is called the thermal impedance of the assembly. The units of thermal impedance remain $^{\circ}\text{C}\cdot\text{cm}^2/\text{W}$, as the derivation is this simple addition. For a typical thermal PCB that is fabricated from multiple materials, the thermal impedance will vary with area, thickness, time, temperature, pressure, humidity, etc. Ideally all of these would be specified on the datasheet, but are understandably not given.

A very typical thermal management PCB for use with LEDs will have a top surface comprising 35 μm (1 oz) copper and a 0.6 mm thick base plate of aluminum alloy. Type 6082 seems to be the current alloy of choice by the market as it provides a good compromise between mechanical and thermal properties, ease of working and price. The thermal impedance of this stack can be measured by a variety of methods, of which the least prone to measurement error is the laser flash technique.

Laser flash thermal diffusivity is based upon the measurement of the temperature rise at the rear face of the thin-disc in response to a short energy pulse on the front face. By using one laser to deliver the energy pulse and another to measure temperature, the entire

measurement system is non-contacting, eliminating external interface resistance errors.

As an example, consider the Nanotherm DM thermal PCB material. The table below gives the materials stack, the thickness of each layer and the thermal conductivity of each.

From this information it is possible to compute a thermal resistance of $0.05\text{ }^{\circ}\text{C}\cdot\text{cm}^2/\text{W}$, as given in the last column. But the calculation takes no account of interface resistance. Measurement by laser flash as well as independent tests using LED arrays, reveals the real-world thermal impedance is actually lower at around $0.047\text{ }^{\circ}\text{C}\cdot\text{cm}^2/\text{W}$. While the explanation for the difference is beyond the scope of this article, the important point for LED system designers is that this metric, namely the measured value of thermal impedance through the entire assembly, is the one parameter needed for product design, yet is frequently unavailable from data sheets.

Once the thermal impedance is known, by measurement or estimation, it is possible to derive the absolute thermal resistance, R_{th} [units $^{\circ}\text{C}/\text{W}$], for use in heat flow calculations. This term is usually abbreviated to ‘thermal resistance’ so only by looking at the units is it possible to discern from a datasheet whether the value is true or absolute.

$$\text{Absolute thermal resistance} = \text{Area} \cdot \frac{\text{Thickness}}{\text{Thermal conductivity}}$$

[units $^{\circ}\text{C}/\text{W}$]

Because absolute thermal resistance is dimensionless it needs to be referred to either a component (e.g. heat sink XYZ is rated $0.3^{\circ}\text{C}/\text{W}$) or a material of given area and shape (e.g. a 1 mm thick round plate measuring 40 mm^2). This is particularly important in real-world situations that involve heat spreading where there will be thermal gradients, since a long thin rectangle will have a different absolute thermal resistance to a square of the same material even if the thickness and areas are the same.

Very low values of absolute thermal resistance are obviously desirable for components used in the thermal management of LEDs.

LED Sub-Mounts and Specific Heat Capacity

Materials for LED sub-mounts are selected primarily on the basis of high thermal conductivity for good reason. As the power of LEDs continues to escalate, more and more manufacturers are being forced to adopt aluminum nitride, despite its high cost, because this is one of the few homogeneous materials available that is a good thermal conductor and electrical

Table 1: Example of a material stack for the Nanotherm DM thermal PCB: The thickness and the thermal conductivity of each layer is given

Material layer	Thickness [m]	Thermal conductivity k [W/m-K]	Length [m]	Width [m]	Thermal resistance [$^{\circ}\text{C}\cdot\text{cm}^2/\text{W}$]
Copper	0.000035	394	0.01	0.01	0.0009
Nanoceramic	0.000010	7	0.01	0.01	0.0143
Al 6082	0.000600	172	0.01	0.01	0.0349
Total	0.000645				0.0498

Table 2: Material properties for different sub-mount materials

Material	Alumina	Aluminium Nitride	10 μm Nanoceramic dielectric on aluminium
Thermal conductivity [W/m-K]	18 - 35 [2]	70 - 180 [3]	Nanoceramic 7 Aluminium 237
Thermal resistance 0.5mm thick [$^{\circ}\text{C}\cdot\text{cm}^2/\text{W}$]	0.277 – 0.143	0.071 – 0.028	0.035 [4]

insulator. Fortunately much cheaper alternatives with comparable, and sometimes superior, performance are beginning to appear. Based on insulated metals substrates, these new sub-mounts need to be wholly inorganic to cope with the high temperature of the die.

Actual values of thermal resistance will be slightly lower due to the circuit traces on both sides of the sub-mount that may be fabricated using either thin or thick-film technology.

One technical area where these new materials excel is in specific heat capacity. This is usually only relevant for LEDs that operate in discontinuous mode. Examples include flash illuminators on machine vision systems and UV polymer cure light sources. Where the "on" period is too short to permit the

complete thermal pathway from the LED to the heat sink to reach thermal equilibrium, the designer has to rely on the specific heat capacity of the sub-mount to act as a temporary store and prevent excessive temperature rise. Aluminum has a higher specific heat capacity (913 J/kg°C) than aluminum nitride (740 J/kg°C), permitting dielectric-coated aluminum sub-mounts to out-perform aluminum nitride in pulsed operation as well as compete strongly in continuous modes applications especially when the cost advantages are taken into account.

Conclusions

As a guiding principle, LED system designers should endeavor to ensure LEDs are run at low temperatures to obtain the best possible

light quality over a long time. An almost universal rule for thermal management of low and medium power LEDs is to bond a patterned copper foil to an aluminum back plate, separated by a dielectric material. Many competing versions of this approach exist, but making comparisons between them is difficult because key data associated with the structure is often not included on manufacturers' data sheets.

High power LEDs are mounted on sub-mounts to first spread the heat before it reaches a thermally conductive PCB. Selection of the most appropriate material for this application depends on the price point of the product and the mode of operation of the LEDs. ■

References:

- [1] US Department of Energy, 2014. CALiPER Retail Lamps Study 3.2 Lumen and chromacity maintenance of LED A lamps operated in steady state conditions, PNNL-SA-23984
- [2] Accuratus Corporation: <http://accuratus.com/alumox.html>
- [3] Surmet Corporation: <http://www.surmet.com/technology/aln/>
- [4] Cambridge Nanotherm Ltd: <http://www.camnano.com/>



LED CHINA 2015



The World's Largest LED and LED Lighting Event
16 - 19 September 2015
Shanghai New International Expo Centre

- 80,000 sqm in exhibition space
 - 90,000 domestic & overseas visitors
 - 1,200 exhibitors and brands
- (The above are projected numbers)

A New Host City Reaching Wider Global Markets



Organizer
UBM Trust Co Ltd
Tel: 86 20 3810 6261, 3810 6263
Email: led-trust@ubm.com
Website: www.LEDChina-sh.com

Shanghai Office
Tel: 86 21 6157 3921
Email: info-trust@ubm.com

Our Network:

Japan
Tel: 81 3 4360 5664
Email: ubmcanonjapan@ubm.com

Taiwan
Tel: 886 2 2738 3898
Email: info-tw@ubm.com

Korea
Tel: 82 2 6715 5406
Email: jameshj.lee@ubm.com

USA
Tel: 1 516 562 7855
Email: cecilia.wun@ubm.com

Analytical and Numerical Studies on the Influence of the Thermal Conductivity of TIMs on the Case Temperature of LED Systems

Thermal management of LED lighting products is such an inherent issue that one would think that most facts are known. Nevertheless, there are some issues that are often not considered enough and it is necessary to draw attention to them. Vinay Pal, Senior Engineer R&D- SSL, Nikhil Aggarwal, Senior Manager R&D- SSL, and Rajeev Jindal, General Manager R&D- SSL at Moserbaer discuss one of these issues; the thermal interface materials, in detail.

This paper reports a comparative analysis of experimental results with a numerical model using a finite element analysis (FEA) approach to understand the influence of thermal conductivity of some commonly used thermal interface materials (TIM) on case temperatures of LED chips used in LED lighting systems. Emphasis is on the research work performed in industries to improve products and practice. The study initiates discussions on need identification, specifications, classification, implications and attributes to be considered while selecting TIM for an application. Temperature contour plots obtained from an FEA simulation of the system is discussed along with its co-relation to an experimental setup subjected to similar boundary conditions. IR camera images are presented

to evaluate the role of TIMs in determining the case temperature of the chip. Performances of readily used silicon based thermal grease, graphite sheet, and thermal PSA acrylic tape is discussed in detail. The paper is summarized with a perspective to enable LED system manufacturers make the right choice in selecting TIM.

Introduction

Heat removal is often a significant endeavor in LED luminaries. Continuous research is on-going to increase efficiency of chip; at present only 25% of supplied power gets converted into light output and the rest dissipates into heat. The heat thus produced increases junction temperature of the diode causing null electron-hole recombination and reduced efficacy [1]. A lower junction temperature of the LED impacts efficiency, life, performance, cost & reliability. Thus heat extraction is a prerequisite of a good LED product. Heat sink designers make use of computational fluid dynamics (CFD) and finite element analysis (FEA) approaches to design efficient and cost optimized heat sinks. It has typical functional dependencies on thermal conductivity of material, fin structure, orientation, color, texture and ambient temperature of surrounding fluid. Usually, commercially available LED

Nomenclature:

BLT	Bond line thickness	A	Cross section area
K_{TIM}	Thermal Conductivity of TIM	Σq	Total rate of heat transfer
R_{bulk}	Bulk thermal resistance	ΔT	Change in temperature
R_C	Contact resistance between two surfaces	$\Delta x, \Delta y, \Delta z$	Change in length in x, y, z direction
R_{TIM}	Thermal resistance of TIM	T_j	Junction Temperature
$R_{effective}$	Effective resistance of thermal interface	T_s	Solder Point Temperature
q	Rate of transfer of heat	R_{th}	Internal thermal resistance of LED
		P	Power drawn per LED
		q	Total heat generated by LEDs mounted on MCPCB

packages are mounted on metal core and FR grade PCB or are chip on board (COB); in either case these heat sources are not bonded with the heat sink and there exists a minor air gap between contacting surfaces.

Certain imperfections always exist while placing one surface over other. Such imperfections can be termed as air gaps, interstitial spaces & voids. Topographically, there is only a 20% surface area [2, 3] that accounts for clear contact between surfaces and rest is an air gap. Bending and wrap age are other factors that increase the air gap area between contacting surfaces. Mounting LED MCPCB on the heat sink also resembles the related case. Air being a poor conductor of heat with thermal conductivity in a range of 0.02 W/m-K, impedes flow of heat flux from chip to heat sink and offers great thermal resistance. These gaps can occur at random locations and trap heat to create heat pockets, a confined and localized collection of heat energy, which may raise junction temperature and drive chip over specified temperature range, subsequently leading to thermal fatigue, poor lumen output, reliability issues and degraded life.

Thus, it is required to use thermal interfacial material (TIM) between two surfaces which can fill these air gaps or voids and reduce overall thermal resistance. In recent years industries have started using thermal grease, thermal tape, carbon based polymer, single and double phase change material types

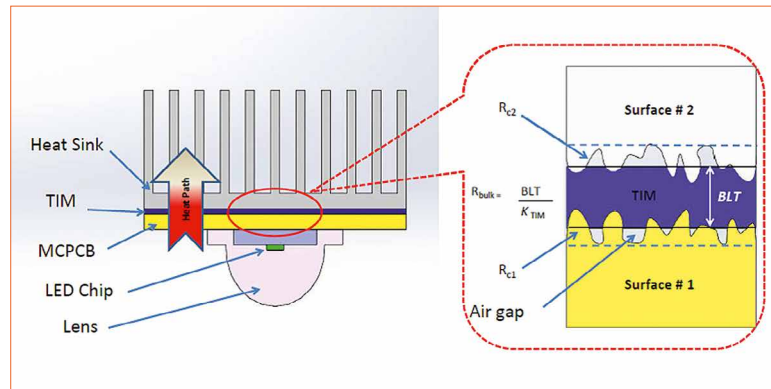

Figure 1: Schematic of an LED system; also represents actual TIM

and filled polymer matrices (elastomers) as TIM. The thermal conductivity of these may vary from 0.5 - 90 W/m-k. Figure 1, represents a realistic situation, [4], total thermal resistance (RTIM) can be stated as

$$R_{TIM} = \frac{BLT}{K_{TIM}} + R_{C1} + R_{C2} \quad (1)$$

Where BLT is bond line thickness, K_{TIM} is thermal conductivity of TIM and R_{C1} and R_{C2} is contact resistance between two bonding surfaces. Reference [5] has stated that total effective thermal resistance at the interface of two surfaces is the sum of resistance due to TIM and contact resistance between TIM and contacting surfaces. This can be stated as

$$R_{bulk} = \frac{BLT}{K_{TIM}} \quad (2)$$

Where R_{bulk} is bulk thermal resistance of TIM.

A versatile range of TIM is available; however one must choose in accordance to particular application concerns. Some of the brief properties are as follows:

Thermal conductivity [K_{TIM}]

It is a measure of ability to transfer heat across the bulk of TIM.

The value is desired to be as high as possible. It has been researched in depth for the past few decades in many countries. Focusing on improvements in thermal conductivity by exploring new materials, combinations, microstructures and controlled application practices. It is the most significant property of any class of TIM. Some of the highest achieved thermal conductivities are reported with carbon nano fibers [6, 7].

Ease of application

Convenience of application and installation is an important characteristic of TIM. A major drawback with thermal greases and gels is inconsistency in thickness, without which, the performance of any product will vary individually. PSA acrylic adhesive tapes are user friendly but offer loss of thermal conductivity. Thin films deposited with metal oxides [8] are good alternatives but its manufacturing is a complex, limited and costly affair. Factors such as morphology,

area of application, turnaround time, and space constraints must be reviewed prior to selection.

Mechanical properties

Contact resistance is the interface resistance between two surfaces. As discussed in equation 1, this is desired to be as low as possible. The surface finish is also crucial in the selection of appropriate TIM.

A viscous material fills the uneven surface more effectively but raises handling and thickness maintaining issues. Carbon based material and tapes have a firm surface and may trap gases between interfacing. Mounting pressure for clamping also affects performance of TIM [9, 10]. High pressure ensures lower contact resistance and improved performance. Solders are susceptible to form oxides with substrate within TIM.

Electrical conductivity

Some applications require electrical isolation, which is also an important specification of product and is liable for warranty terms. A high potential test ranging from 2.5 kV to 4 kV is required to pass for LED based products as bulb, tub lights and street lights. Carbon based TIM, solder and metallic filler matrices show some electrical conductivity.

Table 1:
Summary of characteristics of commonly used TIMs

TIM Classification	Typical Thermal Conductivity Range (W/m·K)	General Description	Typical Composition	Advantages	Disadvantages
Thermal paste, Grease	0.7 - 3.4	Typically silicone based but also found in sodium silicate	<ul style="list-style-type: none"> AlN, BN, Al₂O₃, Ag filler material Silicon compound matrix 	<ul style="list-style-type: none"> High thermal conductivity Low viscosity material easily fills up surface troughs No curing required No delaminating issues Economical 	<ul style="list-style-type: none"> Prone to grease pump-out and phase separation Handling difficulties while application and can contaminate system Hard to maintain thickness
Thermal Conductive Tape	0.5 - 0.95	Adhesive acrylic PSA tape with slight thermal conductivity	<ul style="list-style-type: none"> Acrylic PSA Fiber glass Silicon compound matrix AlN, BN, Al₂O₃, Ag filler matrix 	<ul style="list-style-type: none"> Application and handling better far better than grease, no messy environment in manufacturing Double sided adhesion No pump out No migration Most Economical 	<ul style="list-style-type: none"> Low thermal conductivity Raises problem in rework Possibilities of trapping air while spreading on surface
Carbon based material	Up to 90	Found with various carbon allotropes as in, graphite sheets, diamond, isomolded very fine grains, Carbon nano tubes(CNT)	<ul style="list-style-type: none"> Carbon compound matrix 12C, 13C, 14C 	<ul style="list-style-type: none"> Very High thermal conductivity Convenient handling and application No curing required No de-lamination issues 	<ul style="list-style-type: none"> Require attach pressure which can lead to mechanical Increased stability and less prone to pump-out Most of work done is in laboratory phase and very less available for industry High Cost
Solder	32 - 94	Metals alloys Commonly used for reflow	<ul style="list-style-type: none"> Sn, Ag, Cu Bi, Sn, In In, Ag 	<ul style="list-style-type: none"> High thermal conductivity Enables mechanical bond No pump out issue Easy handling 	<ul style="list-style-type: none"> Can be problematic at high temperature Reflow required Susceptible to oxidation and rusting Possibility of inter metallic growth at interfaces High cost
Phase Change Material	Up to 1.5	Material undergoes phase change to liquid at operating temperature. May contain ceramic or metallic filler particles	<ul style="list-style-type: none"> Epoxy, Polyolefin, polyester, Acrylic matrix AlN, BN, Al₂O₃, Ag filler matrix 	<ul style="list-style-type: none"> Easy application and handling Increased stability and less prone to pump-out No dry out issue No curing required No de-lamination issues 	<ul style="list-style-type: none"> Can gave increased surface resistance than grease, which can be reduced by pre-heating Lower thermal conductivity than grease Require attach pressure which can lead to mechanical stress Flammable



! GET YOUR FREE E-MAGAZINE
www.led-professional.com/free



The leading worldwide authority for
 LED & OLED lighting technology information.

LEDs • OLEDs • Light Engines • Lighting Modules • Optics • Drivers • Thermal Management • Lamps • Fixtures • Production & Measurement Equipment
 Project Reports • Patent Reports • Research Reports • Event Reports

LED
 professional

MORE THAN
23,500
 READERS

www.led-professional.com

powered by Luger Research e.U.

Submit your article. Please contact Arno Grabher-Meyer, Editor in Chief, at a.g-m@led-professional.com

Figure 2:
Geometrical model of
an LED system

Reliability

Longevity with good performance is a highly desirable feature. It must comply with the life of product and other components. Applications such as processors and microelectronics devices in CPU, avionics require life time of 10 years or more.

Outgassing

Most polymers and few elastomers, when subjected to low pressure or elevated temperature outgas to some extent. It is a concern with the aviation sector.

Viscosity

Viscosity above phase change temperature should be sufficiently high to prevent migration issues when held in vertical orientation. It is required to have good wetting abilities to lower contact resistance.

Operating temperature range

It must comply with the operating temperature of the environment. The properties listed above should not degrade with elevation in operating temperatures. Repeated cycling at rated values over long periods of time may involve thermal fatigue.

Cost

Until the technology is fully developed it is not cost viable for industries. Conversely, it is also a fact that until the initial laboratory lot is adopted in industries, the technology cannot be developed. This makes the situation a bit complex. Trade-offs in the right direction helps both industries and the development of technology. A brief summary of typical characteristics of some popular TIMs is tabulated in table 1.

Numerical Model

Model overview

The geometrical model is created using SolidWorks Premium 2014. Figure 2 shows the 3D model of an

LED system with a heat sink, TIM and LED MCPCB of an LED based bulb. Aluminum sheet metal thickness of the heat sink is 0.9 mm with a base diameter of 60.0 mm and a height of 49.0 mm and no fins. Nowadays, heat sink designs with no fins are quite popular and are easily adopted in medium and low wattage ranges below 7 Watt LED bulbs. An MCPCB that measures 35x35 mm with a thickness of 1.5mm, consists of 16 LEDs each measuring 6.3x3.1x0.5 mm. The TIM used to increase heat transfer from the chip to the LED has similar dimensions to that of the MCPCB with 0.2 mm thickness.

Load and boundary conditions

Finite element analysis tool of SolidWorks 2014 is used to analyze the steady state thermal conduction of an LED system.

The following boundary conditions are assumed to solve the model:

- SMD chips mounted on MCPCB are given a total maximum power of 6 watts; LEDs are 25% more efficient, so the total heat load applied is 4.5 watts
- There is no thermal resistance between the LED chip and the MCPCB, that it is perfectly bonded
- The study considers heat flow from the LED chip to the heat sink only. Heat flow from active front sides has been neglected
- The model is iterated with different values of thermal conductivity of TIM. BLT is kept constant at 0.1 mm, to understand the impact of RTIM on the case temperatures of the LED system
- Thermal analysis is carried out at an ambient temperature of 25°C in stagnant air with a simplified case of natural convection cooling at an air convection coefficient of 10 W/m²k
- Maximum size element used for meshing is 0.89335 mm with a minimum size of 0.17867 mm as shown in figure 3
- The analysis assumes constant and similar bond line thickness and contact resistance values in all simulation iterations



Controlling equations

Rate of transfer of heat is described by the Fourier equation given [11].

$$q = K \cdot A \cdot \frac{\Delta T}{\Delta x} \quad (3)$$

Equation (3) can be applied to the model discussed and expanded in three dimensions equation:

$$\begin{aligned} \Sigma q = & K_{LC} A_{LC} \left(\frac{\Delta T}{\Delta x} + \frac{\Delta T}{\Delta y} + \frac{\Delta T}{\Delta z} \right)_{LC} \\ & + K_{TIM} A_{TIM} \left(\frac{\Delta T}{\Delta x} + \frac{\Delta T}{\Delta y} + \frac{\Delta T}{\Delta z} \right)_{TIM} \\ & + K_{HS} A_{HS} \left(\frac{\Delta T}{\Delta x} + \frac{\Delta T}{\Delta y} + \frac{\Delta T}{\Delta z} \right)_{HS} \end{aligned} \quad (4)$$

Where Σq represents net heat transfer rate, K is thermal conductivity, A is cross-sectional area, ΔT is temperature difference and Δx , Δy , and Δz is the change in length in x, y, z direction respectively. The subscript LC, TIM and HS represents corresponding values in the LED Chip, thermal interface material and heat sink, respectively.

In an LED system, to harness maximum lumen output, endeavors are focused on lowering the junction temperature by optimizing the

CIOE

**CHINA INTERNATIONAL
OPTOELECTRONIC
EXPO**



A 360° VIEW OF THE LED INDUSTRY

Expected Exhibitors

3,100

Expected Visitors

85,000

Exhibition Space

110,000 sqm

○ *Materials & Components*

○ *Lighting & Display*

○ *Packaging & Modules*

○ *Manufacturing & Testing Equipments*



**LED
Technia**

SEPTEMBER 2-5, 2015

SHENZHEN CONVENTION & EXHIBITION CENTER

CONCURRENT EVENT



**OPTICAL
COMMUNICATIONS
EXPO**



**LASERS
INFRARED APPLICATIONS
EXPO**



**PRECISION
OPTICS
EXPO**



**Smartcity
China
Expo**

CONCURRENT CONFERENCE



**CHINA INTERNATIONAL
OPTOELECTRONIC CONFERENCE**



WWW.CIOE.CN

mechanical design of the heat sink and using quality thermal interface material with higher thermal conductivity and lower total thermal resistance. Measurement of the junction temperature is almost impractical and a correlation can be arrived by measuring case temperature or solder temperature given by equation [12]:

$$T_j = T_s + R_{th} \cdot P \tag{5}$$

Where T_j is the Junction temperature, T_s is solder point temperature, R_{th} is internal thermal resistance of the LED and p is power drawn per LED.

Thermal simulation

Finite Element Analysis (FEA) approach is used for thermal simulation by SolidWorks Simulation 2014.

Direct Sparse algorithm is used by the solver to solve the model. Elements are tetrahedral in shape with a minimum element size of 0.17 mm. About 25% of the power supplied converts into lumen output and the remaining 75% gets converted into heat dissipation, so the total heat generated by the LEDs in the model is given by:

$$q = 75\% \cdot 6 W = 4.5 W \tag{6}$$

Where q is the total heat generated by LEDs mounted on MCPCB, 4.5 W is the input heat load condition of the simulation.

Figure 4 shows the temperature contour plot of thermal simulation when the heat load of 4.5 watts is applied at the LEDs mounted on the MCPCB having thermal interface material thickness of 0.2 mm and a

thermal conductivity of 2.0 W/mK (similar to that of thermal grease to be used in a test set up) the case temperature of the LED is measured to be 72.07°C. At a steady state, the heat sink shows a temperature vertical gradient direction with the highest temperature, 72.93°C, found at the LED surface and lowest of 66.71°C at the bottom. Fixture condition is applied to heat sink while TIM and MCPCB are bonded with it. Thermal simulation iterations are run at values of 0.95 and 83 W/mK, which represent values of thermal conductivities of thermal tape and graphite sheet respectively so that the thermal simulation results can be investigated apple to apple with actual test results. As shown in figure 5, the analysis was run at values of different thermal conductivity values 0.5, 1.5, 2.0, 2.5, 10, 30, 80 W/mK so as to get a continuous trend over a large span which can be a helpful in estimating the performance or impact of TIM under test. All iterations are done at similar boundary conditions as similar thickness of TIM, contact resistance, input heat load, air convection co-efficient, ambient temperature and the above mentioned boundary conditions except different thermal conductivity. It is to get an overview of the influence of thermal conductivity of TIM in governing the case temperature of the LED system.

As mentioned in equation (1), total thermal resistance of TIM, R_{th} , is a function of thermal conductivity of TIM, thickness and contact resistance with the adjoining surfaces, the FEA simulations are run to investigate impact of thermal conductivity on thermal management of the LED system. As plotted in figure 5, systematic thermal simulation iterations are carried in this paper showing a decrease in case temperatures with the increase in thermal conductivity of TIM. With a thermal conductivity of 0.95 W/mK a case temperature of 74.28°C is measured. An improvement of approx. 2°C in case temperature for an increment of 1 W/m. in thermal

Figure 4: Temperature contour plot of an LED system

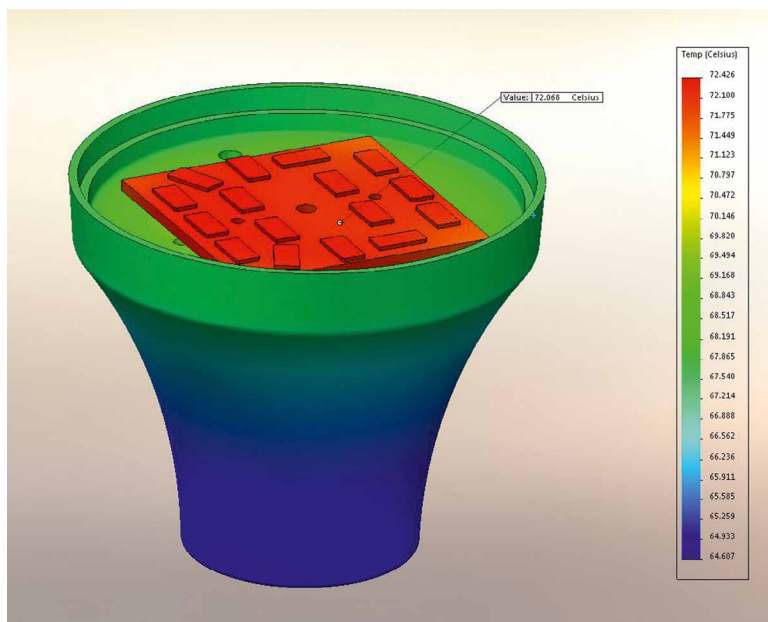
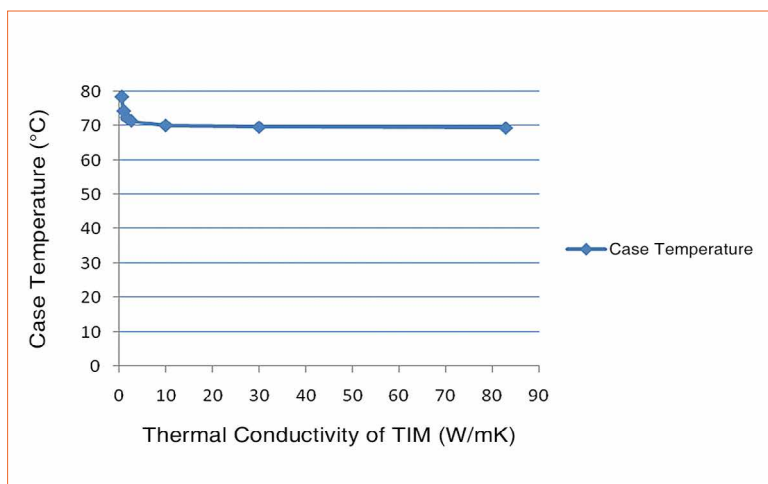

Figure 5: Thermal simulation - variation in case temperature at different thermal conductivities of TIM



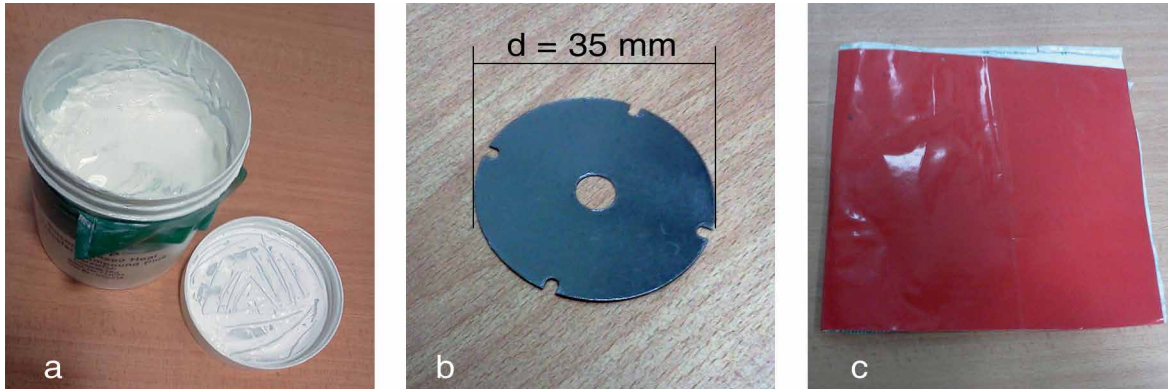

Figure 6: Images of TIM used in test set up - (a) thermal grease; (b) graphite sheet; (c) thermal tape

conductivity of the TIM is observed in lower values below 2.5 W/mK. It can also be inferred from the results plotted that lower and mid range values of thermal conductivity, K_{TIM} has an excellent impact on the thermal management of the LED system. However, in high range values, generally above 15 W/mK, the impact of K_{TIM} is quite small, which eventually becomes insignificant at very high values.

Experimental Work

System overview

The experiment uses a bulb heat sink, LED MCPCB and three different TIMs to be investigated in different test runs as shown in figure 6. The heat sink is made out of two parts manufactured from 1 mm thick silver anodized aluminum sheet metal. The first part is deep drawn outer housing weighing 17 grams, and the second is a depressed plate weighing 12 grams that press fits into first part, upon which the LED is mounted. The design is smooth and is different from conventional designs with fins. This design has gained popularity during the past few years in mid and low wattage segments of LED bulb luminaires. The base diameter is 60 mm and the height is 49 mm. The LED chips mount on a metal core PCB, 1.5 mm and 40 mm in diameter. Wires are soldered at +ve and -ve terminals of the chip and connected to the chords of power supply with connector clips as shown in figure 7. Three trials are conducted using the same housing and chip with a different TIM.

Properties and characteristics of TIM used in a test setup

Thermal Grease: Shown in figure 6a, it is non-curing heat transfer grease based on silicon oil with powdered metal Oxide for thermal conductance. It is white colored with low viscosity. Thermal conductivity claimed in the data sheet is 2.0 W/m-K measured using the Heat Flow method. Specific resistance measures $1 \times 10^{15} \Omega/\text{cm}$. It has a wide operating temperature varying from -50°C to $+200^\circ\text{C}$. Usually it is applied to one of the contact surfaces with a brush, spatula, roller, automated system or screen-printing technique. Its application can be messy with issues in controlling thickness and uniformity.

Graphite Sheet: Shown in figure 6b, it is GM-10 grade, iso-statically pressed graphite flake with 0.35 mm thickness. Thermal conductivity claimed in datasheet is 83.0 W/mK, and resistivity mentioned is $1.4 \times 10^{-2} \Omega/\text{mm}$. The sheet is cut in circular shape with diameter equal to that of LED MCPCB i.e. 35 mm, placed in between chip and heat sink and fixed with 3 screws 120° apart. It has an operating temperature range up to 400°C . Workability is convenient.

Thermal Tape: Shown in figure 6c, thermal conductive acrylic PSA tape has double sided adhesion property. Layer 1 is red colored polyolefin layer with thickness 0.09 mm, adhesive acrylate PSA layer 0.25 mm and white colored paper layer 0.12 mm. Thermal conductivity and surface resistance claimed in data sheet is 0.95 W/mK

and $2.2 \times 10^{11} \Omega$ respectively. The sheet was cut in circular shape with diameter equal to that of LED MCPCB i.e. 35 mm, placed in between chip and heat sink and fixed with 3 screws 120° apart. It has an operating temperature range from -30°C to $+120^\circ\text{C}$. Application is quite convenient.

LED Configuration and test setup

A total of 18 LEDs are mounted on MCPCB with 2 parallel strings of 9 LEDs in series. Voltage applied at the terminals is 20 VDC driving each LED on 150 mA current. Each LED measures $5 \times 3 \times 0.8$ mm. The test starts with supplying a maximum power of 6 watt to the chip through a constant current DC power source. The LED system is kept "ON" for nearly 1 hour to achieve thermal equilibrium as shown in figure 8.

An infrared camera is used to view and capture temperature contour plots every 10 minutes from the

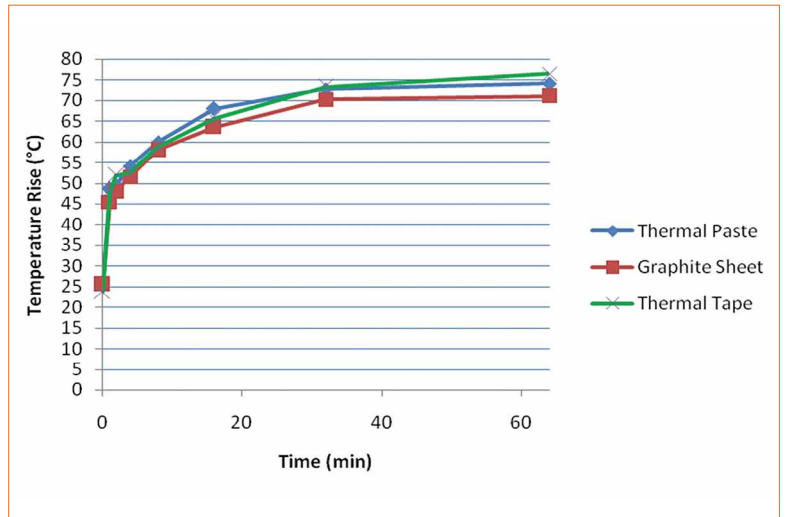

Figure 7: Image of LED system test setup in OFF state

Figure 8 (left):
Image of LED system test setup in ON state



Figure 9 (right):
Case temperature of TIMs measured in test set up



start of the experiment till the final image taken at the 60 minute mark from which the case temperature is reported for the TIM being tested and the junction temperature is calculated.

Results and Discussion

In order to map the exact temperature variation with different TIMs, a scientific approach is adopted to directly measure case temperatures using an IR camera over a time span of 60 minutes as indicated in figure 9. It can be inferred from the plot that each TIM took almost forty-five minutes to reach a steady state condition, the results of which are compared to simulation results in table 2. IR images of TIMs studied at a steady state is shown in figure 10. It can be inferred that the white colored spots in thermal images are the localized hot spots over the LED surface, which is the heat source of the system. These spots are the highest surface temperature zones compared to the rest of the system. The case temperature, since the solder pads of the LEDs also lay on this same plane, is also referred to as Solder Point Temperature.

According to the equation (5), junction temperature, T_j of the LED for thermal tape can be calculated as:

$$T_j = T_s + (R_{th} \cdot P) = 76.5 + (30 \cdot 0.3) = 86.5^\circ C \quad (7)$$

T_s is solder or case temperature, R_{th} is the thermal internal resistance of LED reported at 30°C/W as mentioned. The junction temperature, T_j for thermal grease and graphite sheet and P is power drawn per LED, calculated at approximately 0.3 watts. The maximum limit of T_j is specified at 130°C but it is recommended to consider reduced limits of 40% of the reported rated value, for the best optimized solution; here it is 78°C. T_j for thermal tape is calculated as 86.5°C as shown in equation 6, one of the primary reasons for such high T_j is its inability to creep into the micro terrains of surfaces in contact. This phenomenon causes air to be trapped between the TIM and the surface and increases the contact resistance factor of total thermal resistance. The hindrance to the flow of heat flux from the chip to the heat sink confines it in the bulk of the chip, thereby increasing the

case temperature. On the other hand, thermal grease wets the surface in contact and fills in the contacting surfaces thus reducing the factors of R_{C1} and R_{C2} . The junction temperature with thermal grease and thermal tape achieved are 85°C and 81°C respectively. Table 2 summarizes a good agreement achieved between simulated and test set up results. Since the optimized operating limit of junction temperature for this combination of LEDs and heat sinks is 78°C, it is not recommended to use any of the tested TIMs for application of a 6 watt load.

It is interesting to observe that a graphite sheet makes use of its high thermal conductivity despite it being inapproachable to the micro terrains on surfaces to achieve best performance among three tested TIMs. It is due to the fact that the factor BLT/K_{TIM} is much larger in magnitude and more impacting than R_{C1} and R_{C2} altogether.

It is reported that surface roughness plays an important role in deciding thermal resistance of contact interfaces. Thermal resistance can increase up to 4 to 5 times on doubling the surface roughness [13]. It was also observed in simulation and test set ups that thermal conductivity of the TIM is a critical parameter at higher temperatures as shown in figure 5, which indicates an insignificant increase in case temperatures with an increase of thermal conductivity of the TIM.

Table 2:
Result Comparison - thermal simulation and test set-up

TIM	Thermal Conductivity (W/m-K)	Case Temperature (°C)	
		Thermal Simulation	Test Set Up
Thermal Grease	2.00	72.07	75.00
Graphite Sheet	83.00	69.50	71.00
Thermal Tape	0.95	74.28	76.50

The current and the future of LED & Display Industry

The 13th International

LED & OLED EXPO 2015

2015. 6. 23~26 KINTEX, Korea

Concurrent Exhibition : Int'l LASER EXPO 2015



LED



OLED



Display



LASER



Your best choice 『Int'l LED & OLED EXPO 2015』

- World's first B to B trade show for the LED industry (in 2003)
- Certified by UFI (Union des Foires Internationales) and by Ministry of Trade, Industry & Energy(Korea)
- "Promising Trade Show" for 9 consecutive years(2006~2014)
- Top-tier companies from around the world
- Provide the best business Market Place & Networking.



Tel : 02-783-7979 Fax : 02-783-7292
E-mail : led@exponu.com oled@exponu.com
Website : www.ledexpo.com www.oledexpo.com

<http://twitter.com/ledexpo>
<http://www.facebook.com/LEDEXPO/>
<http://www.ledexpo.net/>



LEDEXPO



OLEDEXPO

Figure 10:
Infrared camera images
of an LED system test
setup with TIM - (a)
Thermal grease (b)
graphite sheet (c)
thermal tape

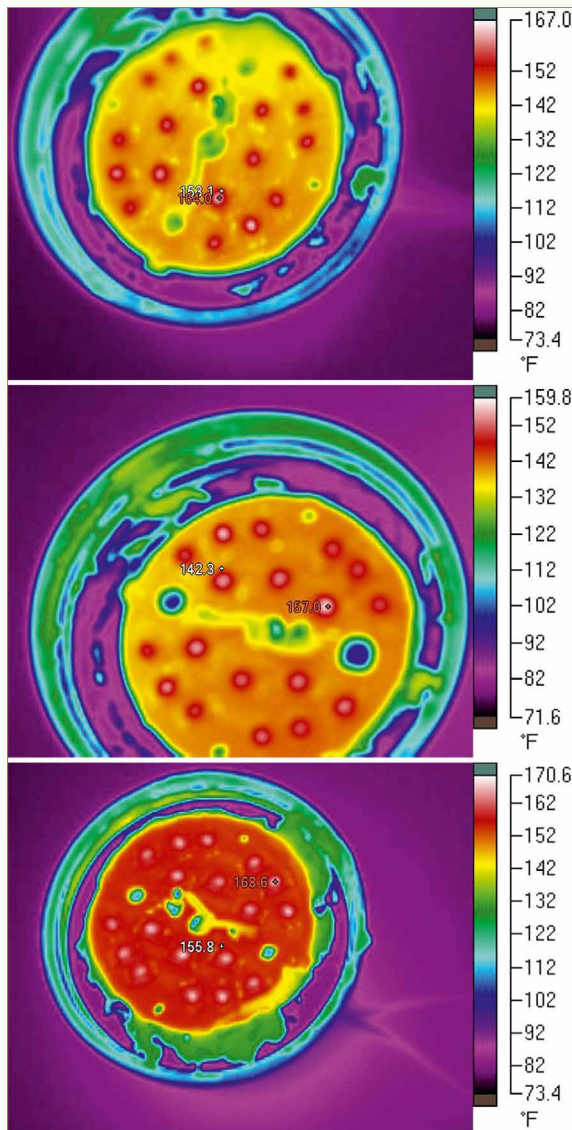

Conclusions

The significance of thermal management in LED systems has led to the investigation of thermal interface material, which facilitates heat transfer by conduction from LED chip to heat sink. A numerical simulation model and a method to measure performance of the TIM are described. The experiments to evaluate performance of different TIMs were investigated and an excellent agreement is obtained between results of numerical simulation and experimental data. The results showed that when carbon based TIM, graphite sheet at a thickness of 0.35 mm, is used as the thermal interface material between the heat sink and the MCPCB at a load of 6 watts, it measured a case temperature of 71°C. It was also investigated through thermal simulation that states of lower temperature of the LED chip mounted on a heat sink is proportional to thermal conductivity of the TIM, although it also a function of the bond line thickness, area of contact and contact resistance of surfaces. Case temperature, being directly proportional to junction temperature, is inversely proportional to the lumen output of an LED system. It can also be inferred that CNT, nano particles has an edge cutting advantage over conventional TIM and is inevitable.

However, it can also be inferred from the findings of the paper that only thermal conductivity of the TIM is not a single factor responsible for the performance of the TIM and good thermal management of an LED system; Contact resistance and bond line thickness of the TIM also play a crucial role. It is also required to closely investigate, in totality, the cumulative influence of the above factors on the thermal management of an LED system. Hence while selecting TIM for a particular application, a decision should be taken on considering factors in totality and not just thermal conductivity. ■

References:

- [1] S.L Chuang, "Kinetic model for degradation of light emitting diode", IEEE J. Quant. Elec, Vol. 33, No. 6, 1997, pp 970-979
- [2] M.M. Yovanovich and E.E. Marotta, "Thermal spreading and contact resistances" in Heat Transfer handbook, A. Bejan and A.D, Eds. Hoboken, New Jersey: Wiley, 2003, pp. 261-395
- [3] C.V. Madhusudana, Thermal Contact Conductance. New York: Springer-Verlag, 1996
- [4] R.Prasher. Surface chemistry and characteristic model for the thermal contact resistance of fluidic thermal interface materials. J. Heat Transfer, Vol 223 pp. 969-975, 2001
- [5] Mathias Ekpu, Raj Bhatti, Ndy Ekre, Sabuj mallik, kenny otiaba, DTIP april 2012, Cannes / France
- [6] Melechko, A.V., et al., vertically aligned carbon nano fibers and related structures: Controlled synthesis and directed assembly. Journal of Applied Physics, 2005. 97(4): pp. 041301-1-041301-39
- [7] F.P. Incropera, D.P. Hewitt, T.L. Bergman and A.S. Lavine (2007). Fundamental of Heat and Mass Transfer. 6th Edition. USA: John Wiley and sons, Inc. pp. 2-925
- [8] S. Shanmugam, D.Mutharasu, O.Zeng Yin. Performance of Light emitting diode on surface machined heat sink. International journal of Power Electronics and Drive system(IJPEDS), Vol 2, No .4 December 2012
- [9] Latham, C.A., "Thermal resistance of interface material as a function of pressure", Electronics Cooling, September 1996
- [10] Zweben, K., "Thermal Materials Solve Power Electronics Challenges", Power Electronics Technology, February 2006, pp. 40-47
- [11] R. S. Prasher, "Rheology based modeling and design of particle laden polymeric thermal interface material," presented at the 2004 Intersoc.Conf. Thermal Phenomena Las Vegas, NV
- [12] V. Pal, Thermal modeling of scales on fins of heat sink cooled by natural convection in IJRET, vol 03, issue 6 June 2014
- [13] M.M Yovanovich, W.M Rohsenow; Influence of surface roughness and waviness upon thermal contact resistance, Technical report No. 6361-48, June 1967, published by Massachusetts Institute of Technology, Cambridge, Massachusetts 02193

ILLUMINOTRONICA

HUMAN CENTRIC LIGHTING TECHNOLOGIES

PADUA - ITALY, 8-10 OCTOBER 2015

www.illuminotronica.it



LED LIGHTING

solutions & design

for those who design, manufacture
and supply luminaires and systems
for **outdoor** and **indoor** lighting

SMART HUT

*home automation
for
the human well-being*

products and technologies (hardware
& software) to manage and control
lighting e safety

elettro & micro

*up to date
on the electronics industry*

Assodel meeting point for
technicians and companies

**the unique event existing in Italy*



assodel



TECNO
IMPRESE



LED professional Review (LpR) - Annual Subscriptions

LpR Digital Magazine

- 6 issues
- pdf download
- high resolution pictures and graphs
- printable
- commercial use
- access to all previous issues
- Euro 78.80

LpR Printed Magazine

- 6 issues
- Euro 158.40

<http://www.led-professional.com/subscription>

Cover-page

Artwork: Thomas Klobassa,
©LED professional 2015

Main Image: Arno Grabher-Meyer,
LED professional

Product: Code Mercenaries LED-
Warrior 04 Development Board

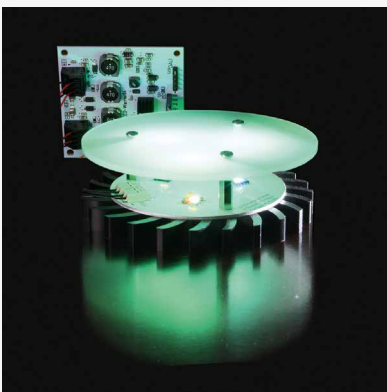

The fully functional Code Mercenaries LED-Warrior 04 Development Board allows programming, testing and development of RGBW based human centric lighting scenarios

Next LpR 50th EDITION - July | Aug 2015 - Short Overview

TECH-TALKS BREGENZ

Karl Jónsson, IoT Architect
at Tridonic

The CEO of the Zumtobel Group, Ulrich Schumacher, recently named Tridonic the "Electronic Brain" of the Group. With the employment of Karl Jónsson, Tridonic has affirmed their strong commitment to intelligent and IoT based products. Mr. Jónsson will talk about the evolution of modern IoT and the role of the lighting business in the IoT of the future. ■

TECHNOLOGIES

Lighting with LEDs – More than just
Illuminating Objects

LEDs as a digital light source offer new technical possibilities for fulfilling special visual, biological and emotional requirements. At the same time our knowledge about how lighting affects people has increased significantly. The article gives an overview of the experiences with LED lighting up until now and the latest findings in lighting effects. Recommendations will be given to improve future LED lighting. ■

InGaN Nanowire LEDs to Make Light Mixing Efficient and Smart

The CCT of high CRI LED lighting systems can, in principle, be tuned over a wide range. As an alternative approach to conventional phosphor based LEDs, a full-color LED array consists of red, green and blue (RGB) InGaN based nanowire LEDs monolithically integrated on a micro-scale level. The three multi-color subpixels can be separately biased and the emission spectrum can be tuned in a wide CCT range. ■

New Class of Siloxane Polymers for Advanced LED Packaging

Packaging presents a major challenge to further improve LED device efficiency and reliability. A novel class of high stability siloxanes, based on proprietary monomers and polymers in combination with novel nanomaterials, forms a technology platform to address such opportunities in die attach, encapsulation, and light outcoupling applications. These new materials enable products fully compatible with current process tools and flows while having superior properties. ■

RESEARCH

"Best Papers" at LpS 2014:
Flexible OLEDs for Lighting
Applications

OLEDs, especially the flexible ones, are recognized as being the lighting products of the future for some applications. However, in some respects they are currently lagging behind LED technology. Manufacturing costs is one of the obstacles. Roll-to-roll (R2R) manufacturing seems to be the best approach. The article describes which key technology developments are required to come to a R2R compatible process with high yield for manufacturing flexible OLEDs. ■

subject to change

Imprint

LED professional Review (LpR), ISSN 1993-890X

Publishing Company

Luger Research e.U.

Institute for Innovation & Technology
Moosmähdstrasse 30
A 6850 Dornbirn, Austria / Europe
phone +43 5572 39 44 89
fax +43 5572 20 60 70
[info\(at\)lugerresearch.com](mailto:info(at)lugerresearch.com)
www.lugerresearch.com

Publisher

Siegfried Luger +43 5572 39 44 89-70
[s.luger\(at\)led-professional.com](mailto:s.luger(at)led-professional.com)

Editor-in-Chief

Arno Grabher-Meyer +43 5572 39 44 89-18
[a.g-m\(at\)led-professional.com](mailto:a.g-m(at)led-professional.com)

Research & Innovation Manager

Dr. Amrita Prasad +43 5572 39 44 89-19
[amrita.prasad\(at\)led-professional.com](mailto:amrita.prasad(at)led-professional.com)

Int. Account Manager

Theresa Koenig +43 5572 39 44 89-20
[theresa.koenig\(at\)led-professional.com](mailto:theresa.koenig(at)led-professional.com)

Marketing & Sales Manager

Katharina Fink +43 5572 39 44 89-43
[katharina.fink\(at\)led-professional.com](mailto:katharina.fink(at)led-professional.com)

Your Local Contacts

China, Hong-Kong

Iris Yuen +86 1380 27 01 367
[irisyuen88\(at\)gmail.com](mailto:irisyuen88(at)gmail.com)

Germany

Armin Wezel +49 30 526 891 92
[armin\(at\)eurokom-media.de](mailto:armin(at)eurokom-media.de)

India

Anisha Dabas +91 124-478 7411
[anishad\(at\)binarysemantics.com](mailto:anishad(at)binarysemantics.com)

Japan

Eiji Yoshikawa +81 3 6751 0090
[scala\(at\)s3.dion.ne.jp](mailto:scala(at)s3.dion.ne.jp)

South Korea

Jung Won Suh +82 2 78 58 222
[sinsegi-2\(at\)sinsegi-media.info](mailto:sinsegi-2(at)sinsegi-media.info)

Switzerland

Monika B. Ailingner +41 41 850 44 24
[m.ailingner\(at\)marccomedia.ch](mailto:m.ailingner(at)marccomedia.ch)

Taiwan

Leon Chen +886 2 256 81 786-10
[leon\(at\)jkmedia.com.tw](mailto:leon(at)jkmedia.com.tw)

United Kingdom, France & Benelux

Zena Coupé +44 1923 85 25 37
[zena\(at\)expomedia.biz](mailto:zena(at)expomedia.biz)

US East

Karen C Smith-Kernc +1 717 397 7100
[KarenKCS\(at\)aol.com](mailto:KarenKCS(at)aol.com)

US West & Canada

Alan A. Kernc +1 717 397 7100
[AlanKCS\(at\)aol.com](mailto:AlanKCS(at)aol.com)

Copyrights - Luger Research e.U.

The editors make every reasonable effort to verify the information published, but Luger Research e.U. assumes no responsibility for the validity of any manufacturers, non profit organisations or individuals claims or statements.

Luger Research e.U. does not assume and hereby disclaims any liability to any person for any loss or damage caused by errors or omissions in the material contained herein, regardless of whether such errors result from negligence, accident or any other cause whatsoever. You may not copy, reproduce, republish, download, post, broadcast, transmit, make available to the public, or otherwise use LED professional Review (LpR) content without prior written consent from Luger Research e.U. - Institute for Innovation & Technology, Austria. ■

THE WORLD'S LARGEST SELECTION OF ELECTRONIC COMPONENTS AVAILABLE FOR IMMEDIATE SHIPMENT!™



**OPEN
ACCOUNTS
AVAILABLE**
FOR QUALIFYING
CUSTOMERS



**FREE
SHIPPING
ON ORDERS
OVER €65***



**LOCAL
SALES &
TECHNICAL
SUPPORT**



Free Online Tool
Access the BOM Manager now!
DIGIKEY.COM/BOMMANAGER



FIND CONTACT AND ORDERING
INFORMATION FOR YOUR REGION AT
DIGIKEY.COM/EUROPE

1,000,000+ PRODUCTS IN STOCK | 650+ INDUSTRY-LEADING SUPPLIERS | 3.9 MILLION PARTS ONLINE

*A shipping charge of €18.00 (£12.00) will be billed on all orders of less than €65.00 (£50.00). All orders are shipped via UPS for delivery within 1-3 days (dependent on final destination). No handling fees. All prices are in euro and British pound sterling. If excessive weight or unique circumstances require deviation from this charge, customers will be contacted prior to shipping order. Digi-Key is an authorized distributor for all supplier partners. New product added daily. © 2015 Digi-Key Electronics, 701 Brooks Ave. South, Thief River Falls, MN 56701, USA

Small is Big

4,5
mm



For Manual and
Automated Wiring Systems
2060

5,6
mm



For Direct
Power System Feed-In
2061

2,7
mm



For the
Smallest Sizes
2059

The Range of SMD Terminal Blocks

www.wago.com/smd

**WE
INNOVATE!**



WAGO[®]