



Interview: Ruairí O'Brien

Research: Freeform Micro-Optics

Technologies: Tuneable White & Smart Lighting

Special Topic: Peripheral Discomfort Glare

 **NICHIA**  
See page 7



# CERTAMATCH SOLUTIONS for Troffer and High Bay Fixtures

## The Market Trend

Average unit prices of high-running indoor LED fixtures are plummeting.

OEMs are resorting to importing and reselling finished fixtures or using lower cost components with minimal warranty or technical support in order to remain competitive.

## There is Another Way...

What if you could have **high quality** components at a **competitive price**?

What if you could have onshore sourcing for **shorter lead times**?

What if your components had a **5 year limited warranty** that is serviced by your components supplier?

## CertaMatch:

### A Perfectly Paired Module + Driver System

- Designed for common lumen outputs
- Normal and premium LPW for external certifications
- Out of the box ready, no programming needed
- Ideal for Stock and Flow Luminaires
- Made in North America for reduced lead times
- Fast Approbations
  - Fortimo QuickCheck program
  - Drivers are UL Class P Listed
- 5 Year limited warranty

For the latest information on Signify products contact your local FLS sales representative.

This information is accurate at the time of writing. Neither Signify nor its agents assume any liability for inaccuracies or losses incurred by use or misuse of this information. Check manufacturer's website for the most recent information.

# Next generation automotive measurements!



Visit us at Booth #716

11 – 13 Feb 2020, San Diego / USA



**Strategies in Light**

## **LumiCam 2400B: 2D Imaging Colorimeter for Automotive Applications**

- ▲ Motorized aperture and focus
- ▲ At least 50 % faster measurements
- ▲ 25 % shorter housing
- ▲ Multiple measurement features:  
variable spotmeters, polygons and 3D-objects
- ▲ Calculation of luminance distribution, color  
coordinates / temperature, Planck distance,  
dominant wavelength, contrast and many more
- ▲ New software features:  
Polylines and Sticking Image

**NEW**  
LumiCam  
2400B



**We bring quality to light.**



# Experience the Future of Lighting

The LpS/TiL/DALI Summit 2019 event is over. They were intensive days where the latest trends in applications and technologies were discussed. What are the key insights that we can derive from this?

Sustainability seems to have a new value in the world of light. It's about developing sustainable systems and using light sustainably. Life Cycle Assessments (LCA) show materials and energies that need special attention. Many new system developments show new approaches to solutions in precisely these areas. Repro-Light, an EU-funded project, is investigating new solutions for sustainable lighting. In particular, the issues of modularity, upgradeability and recyclability play a major role in this project.

The quality of light, greater miniaturization and digitization and the handling of data remain further trendsetters in the field of light. In this LpR issue we also deal with the topic of Visual Perception, which was also discussed in detail - also in connection with Human Centric Lighting - in Bregenz.

A detailed post-show report can be found in this issue as well.

Industrial revolutions always occur when major changes occur at the same time in the areas of communication, energy and mobility. There is no doubt that we are experiencing this to a large degree today - lighting is also affected by this and can make a very significant and positive contribution to the future development of society.

In this new smart world, we also need a stronger commitment to the environment. With light, we have an essential resource in our hands.

Yours Sincerely,

Siegfried Luger  
Publisher, LED professional



**Almost too beautiful  
just for the road –  
lighting design with  
PLEXIGLAS®.**

What does PLEXIGLAS® have to do with car design? For over 60 years, PLEXIGLAS® molding compounds have been a driving force behind the auto industry. Why? Because the multifaceted ways in which PLEXIGLAS® can be formed open up virtually endless possibilities for design. One shining example is crystal-clear or colored PLEXIGLAS® whose top light-guiding properties and color stability make for innovative automotive lighting systems. For more inspirational PLEXIGLAS® products, go to [www.plexiglas-polymers.com](http://www.plexiglas-polymers.com).

**PLEXIGLAS®** 

The Original.

COMMENTARY

- 08 Personal Lighting Profiles Might Be the Key to Creating a Natural "Work Light Balance" by Henrik Clausen, Fagerhult Lighting Academy

TECH-TALKS BREGENZ

- 30 Ruairí O'Brien, Founder of Ruairí O'Brien Lighting Design compiled by Dr. Guenther Sejkora, LED professional

RESEARCH

- 40 Micro-Optics for Efficient LED Spotlights with Arbitrary Farfield Distributions by Dr. P. Schreiber and Dr. Ch. Waechter et al., Fraunhofer IOF

EVENTS

- 48 LpS & TiL 2019 Post Show Report – Focus on Applications and New HCL Ideas by Arno Grabher-Meyer, LED professional

TECHNOLOGIES

- 68 A White Light Tuning Strategy that Fuels HCL by Wouter Soer, Lumileds
- 74 A New LED Controller Technology to Expedite the Next Level of Smart Lighting by Kurt Marquardt, Infineon Technologies
- 78 Fluorescence-Free Radiant Flux Measurement of UV LEDs by M. Clark, R. Zuber & M. Ribnitzky, Gigahertz-Optik

REGULATIONS

- 82 New Ecodesign Regulation on Flicker and Stroboscopic Effect in LED Lighting by M. Przybyla & P. Czarnecki, GL Optic

SPECIAL TOPICS

- 86 Measure Influence of Discomfort Glare on Task Performance Using the Stroop Task to Circumvent Participant Assessments by Mads Mårbjerg, Buro Happold Engineering Berlin

REGULARS

- 04 EDITORIAL
- 08 COMMENTARY
- 10 COMPONENT NEWS
- 18 APPLICATION NEWS
- 20 RESEARCH NEWS
- 24 ORGANIZATION NEWS
- 28 REGULATION NEWS
  
- 94 ABOUT | IMPRINT

HIGHLIGHTS

- 30 Ruairí O'Brien, Ruairí O'Brien. Architektur. Licht Raumkunst compiled by Dr. Guenther Sejkora, LED professional

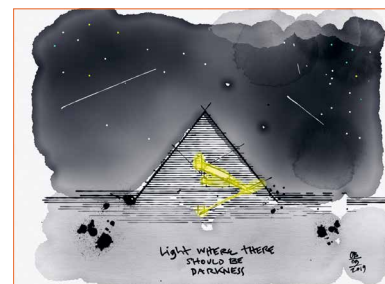

- 40 Micro-Optics for Efficient LED Spotlights with Arbitrary Farfield Distributions by Dr. P. Schreiber and Dr. Ch. Waechter et al., Fraunhofer IOF



ADVERTISING INDEX

FUTURE LIGHTING SOLUTIONS	1	CREE	9	LPS	67
FLS-SIGNIFY	2	FLS-LUMILEDS	21	HEP	77
INSTRUMENT SYSTEMS	3	NICHIA	27	TOPLITE INTERNATIONAL	85
EVONIK	5	GLD	29	LPR	95
FLS-NICHIA	7	TIL	47	WÜRTH	96



# LIGHT SHAPES OUR LIFE

## Why settle for just one spectrum?

**Nichia's Vitasolis™ & Optisolis™**

Combine to create true Human Centric Lighting

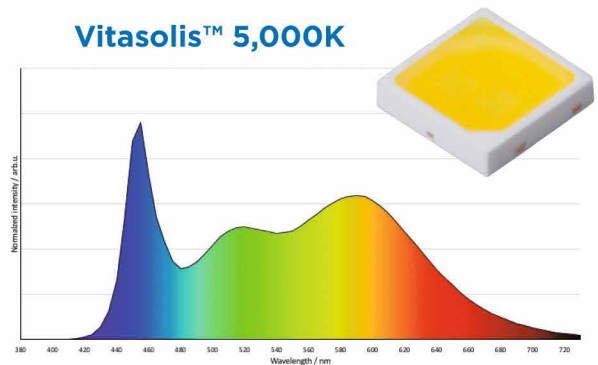
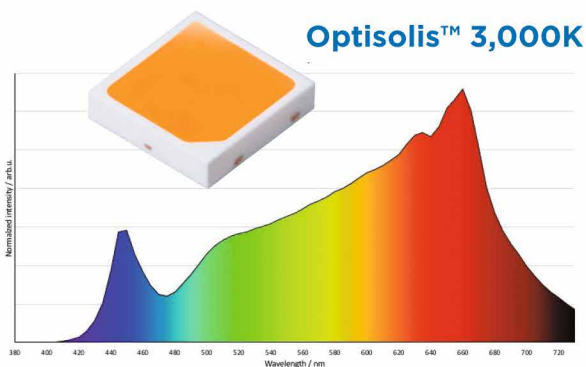

**Request Your FREE Samples Now!**

[www.bit.ly/FLSNichiaSamples](http://www.bit.ly/FLSNichiaSamples)



[www.NICHIA.com](http://www.NICHIA.com)



[www.FutureLightingSolutions.com](http://www.FutureLightingSolutions.com)



### Henrik Clausen

B Eng; M IDA, M IESNA,  
Associated Professor, AAU

Henrik has been involved in lighting for over 30 years in both commercial and academic positions.

In 1996, he became the Managing Director of Fagerhult Lighting in Denmark, and held that position until 2004, when he founded the Fagerhult Lighting Academy.

In 2015 he also became Head of Research for Fagerhult. Henrik holds a position as professor in Lighting Design at AAU in Copenhagen. He guest lectures at various Universities around the world. He speaks worldwide, primarily addressing the human and emotional aspects of light and lighting design.

## PERSONAL LIGHTING PROFILES MIGHT BE THE KEY TO CREATING A NATURAL "WORK LIGHT BALANCE"

What do I mean by a natural "work light balance"? - I dream of creating a world where the lighting control lies in the hand of the end users. Where preprogrammed lighting scenes are attuned to our internal, ancient, natural biology.

We're getting older. Not just individually, but collectively. According to United Nations estimates, the number of people over the age of sixty will have more than tripled by the end of this century. Such exponential growth in our older generations is symbolic of global progress and prosperity. But could the spaces we occupy be eroding our quality of life as we age?

The capacity to receive and respond to light changes dramatically as we reach the later stages of life. Just like the muscles in our arms or legs, our lens muscles start to lose elasticity. Focusing gets harder and blurred vision ensues. Yellowing of the lens can affect color perception. We find it fatiguing to transition between high and low-light conditions. As people will work into their 70s and beyond, the principles we apply to lighting design must respond to their changing needs. To facilitate the health and wellbeing of our fastest growing generation, we need to start thinking about illumination in an entirely new light.

Employees have the choice to stand or sit, adapting their workspace to align with personal preferences. Offices now have a selection of zones, some geared towards quiet concentration, others designed for active collaboration. The archetypal worker is young, but lighting in the workplace must support the productivity, comfort and wellbeing of people at all ages.

While our understanding of light's impact on humans is far from comprehensive, science has drawn direct connections between light, bodily timing (circadian rhythms) and hormones.

Put simply, lighting is vital for our health. We do know that blue light is a crucial component of daylight that contributes to synchronization of the circadian clock, human alertness, memory and mood. Similarly, low levels of light—particularly amber light—can promote better sleep.

I believe that the universalization of lighting design is about empowering people to personalize their lighting to suit the tasks they undertake, at the time of day (and indeed time of life!) in which they complete them. To do this properly, we need a better understanding of the many variables that influence how we respond to light stimuli throughout our life.

Research shows that human centered lighting design makes people feel more alert, productive and happy. More detailed studies are required to help us understand how light affects performance across a broader range of visual, biological and emotional metrics.

I believe that this research could yield valuable results for businesses in terms of enhanced productivity, wellbeing and employee retention, and help us to explore new possibilities to harness light as a powerful force for preventative health, emotional resilience and general wellbeing.

With the help of technology, the potential for 'light personalization' in the workplace is huge. With an app, and a strategic combination of overhead, task and ambient light sources, workers can be empowered to dial up blue light in the morning to feel energized and more focused or increase amber light in the afternoon to feel more relaxed, reduce stress and promote calm.

The challenge, should we wish to accept it, is creating a world of 'work light balance' where illumination control is in the hands of the worker and lighting schemes are attuned to our internal, ancient, natural biology. ■

H.C.





BARRIER-BREAKING, GAME-CHANGING, INDUSTRY-LEADING—WE MAY RUN OUT OF ADJECTIVES, BUT

# WE'LL NEVER RUN OUT OF INNOVATION

SEE THE COMPLETE PORTFOLIO AT: [CREE.COM/LED-COMPONENTS](http://CREE.COM/LED-COMPONENTS)

**CREE** 

## Xicato Announces Availability of XOB with 14.5 mm LES

Xicato, the leading provider of smart building wireless controls and highest quality light sources, announced the immediate availability of the XOB high-density light source in 14.5 mm LES with nearly 5,000 lm output. The benchmark light quality of XOB series with an R9 of 50 at 90 CRI and an R9 of 90 at 95 CRI provide the best options for strong color rendering in industry standard sizes for easy adoption.

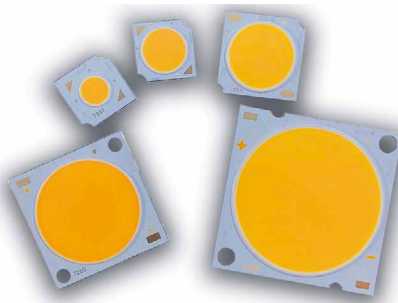

**XOB delivers the most beautiful, consistent, natural light that specifiers and end users have been craving, now also with an LES of 14.5 mm**

Applications for the powerful output of the 14.5 mm LES include office, hospitality, residential and healthcare just to name a few. The 14.5 mm LES XOB has had strong demand from light designers who need the same quality offered in the Company's 6 and 9.8 mm LES XOBs with the consistency of color point for seamless integration where comfort, color matching and quality matter. ■

## Luminus Salud™ LEDs Suppress Melatonin and Deliver Warm, Comfortable Illumination

Luminus Devices expands its illumination portfolio today with the introduction of the Salud line of 3030 mid-power LEDs. Salud LEDs are the first with datasheet specified melanopic ratios (MRs) in addition to CRI, R9, CCT, and Flux. By enhancing

the spectrum with cyan for melatonin suppression and enriching the 660 nm emission for natural skin tones and excellent red-rendering, Luminus Salud LEDs can deliver warmer, more comfortable light that keeps people healthy, alert, and productive.

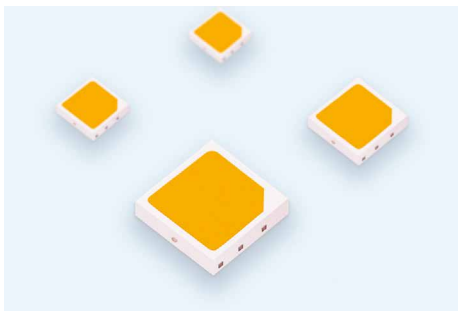

**With Salud™ LEDs, Luminus specifies melanopic / photopic ratios (MRs) for new human centric lighting LEDs**

Scientists studying human circadian rhythm and the physiological reaction to light have determined that low MRs are a signal to the body to prepare for sleep, and higher MRs tell the body to be more alert.

Standard warm CCT LEDs (3000 K to 4000 K) commonly used across the lighting industry have low MRs, which can reduce alertness and productivity. Cool CCTs have high MRs and people are generally awake and alert in this light. However, in offices and other public spaces, such cool CCTs are considered too "blue" and typically not desirable.

Salud bridges the gap with warm CCTs and high MRs for healthy, productive, and comfortable environments. Salud LEDs and datasheets are immediately available. ■

## Bridgelux - New Lighting Solutions, Naturally

Enabling LED industry transformation for over 15 years, Bridgelux has reinforced its focus and commitment to the lighting market with the commercial availability of Thrive™ surface mount device (SMD) 2835 and V Series™ chip-on-board (COB) parts. Thrive white point options are designed to closely match the spectra of natural light by reducing blue spikes and cyan valleys, and providing full spectrum, human centric LED lighting solutions.



**New human centric lighting options help customers navigate the next phase of LED lighting. Bridgelux's Thrive white point options are designed to closely match the spectra of natural light**

The loss of natural light benefits affects those who spend most of their time indoors, with office workers being one of the groups especially at risk. According to Harvard Business Review, the "health benefits of access to natural light are causing some firms to re-imagine their workspace and tout this as a recruiting tool." [1] The lighting industry is moving beyond the efficacy race and towards human centric lighting solutions incorporating circadian elements that may impact well-being for anyone spending extended periods of time indoors.

Thrive uses proprietary chip, phosphor and packaging technologies to deliver a close spectral match to natural light. The high-fidelity spectral output of Thrive creates stunning environments with excellent color rendering and outstanding TM-30 metrics. Unlike other high CRI light sources, Thrive has been engineered specifically to provide a close and continuous match to natural light across the visible wavelength range to enable the next wave of innovation in the lighting market: human centric lighting.

Thrive SMD 2835 1 W 9 V and V10C are now available for ordering. Additional SMD 2835 and V Series form factors will be available in late Q4 and early Q1 2020.

"Today's announcement reflects our pledge to customers to deliver a clear path toward flexible, interoperable solutions to meet lighting requirements that demand natural-looking light, particularly projects in the office, education, healthcare, residential and retail markets," said Dr. Brian Cumpston, Vice President of Solutions Development at Bridgelux. "We are a technology partner committed to delivering new LED light source solutions as our roadmap evolves, including an expansion of Thrive white options onto our Vesta® Series and EB Series™ tunable white light sources, and the expanding family of high efficacy SMD products."

Bridgelux also announced performance upgrades to its SMD 2835 delivering up to 221 lumens/watt (lm/W), and to its SMD 4014, now delivering up to 190 lm/W, both in 4000 K 80 CRI with a variety of 80 and 90 CRI color point options available. These highly efficient light sources are useful for a range of lighting applications including office, retail, residential and architectural lighting, further assisting customers to meet ever evolving regulatory based efficacy requirements. ■

## Everlight Releases EL SmartLED Series for Automotive Interior Applications

Everlight Electronics, a leading player in the global LED and optoelectronics industry, releases a new generation of lighting products for automotive interior application to bring more convenience to our life. The new EL SmartLED (S-Smart, M-Multi Function, A-Automotive, R-RGB, T-Technology) Series is suitable for automotive interior lighting applications to present colorful combinations in the vehicle interior. Featuring a unique package technology to achieve improved uniformity of light, the EL SmartLED Series embedded intelligent IC driver can better manage colors and adjust brightness via a controller. We expect to provide complete and smart solutions for OEMs.



**Everlight's SmartLED utilizes the ISELED communication technology for automotive applications**

Everlight has officially become a member of the ISELED Alliance, which is to develop intelligent RGB LED technology for automotive interior and provide innovative solutions for automotive lighting. With the continuous global technology evolution and the transfer of the automotive industry to digitalization, vehicle interior lighting has grown substantially to improve the user experience. In order to comply with the ongoing trend smart innovation research and development, Everlight employs ISELED to release EL SmartLED (XI3040-RGBIC0251L-AM) with an embedded IC.

EL SmartLED developed by Everlight integrates the driver IC into RGB LED package, which can control chromatic aberration within SDCM (MacAdam Ellipse). The integrated driver IC allows control of thermal runaway by temperature sensing of the red LED. The EL SmartLED has the capability to gang up to 4,000 LEDs in

series via LIN interface with a transmission speed of 2 Mbps. Compared to a traditional solution for RGB LED, EL SmartLED provides better color uniformity. In addition, EL SmartLED has been developed for AEC-Q102. A wide application range for lighting the automotive interior includes interior light, roof reading lighting and dashboard display. The dimension of this SMD package is 3.0x4.1 mm to implement the best optical performance. ■

## Unveiled at LpS 2019: Nichia's 2-in-1 Tunable White LED Begins Changing the Game

Nichia, the leader in and inventor of the high-brightness LED, announced its game-changing single LES, tunable white mid power 3030 LED to the public on September 19th. The game changing NF2W757G-MT was unveiled, in detail, one week later at LpS 2019 in Bregenz, Austria. As previously announced, this cutting-edge technology gives design and operational freedom to luminaire manufacturers around the world.



**Nichia's Tunable 757 receives rave reviews from industry leaders, including the coveted LpS Best Sustainability Technology Award**

NF2W757G-MT uses the standard 757 package with new patented technology to allow the user to smoothly transition CCT's from 6,500K to 2,700K. The significant innovation is its ability to accomplish color tuning under a small, single light emitting surface (LES), thus achieving superb color uniformity with high color quality; up to 90 CRI in the popular CCT's. The 2-in-1 tunable white 757 enables thinner, sleeker optical designs, eliminating the need for bulky mixing chambers.

In addition to remarkable color, NF2W757G-MT allows users to improve operational efficiency. With performance on par with the primary 757's shipping today, the industry's

#1 mid power LED, CCT can now be selected with ease at the time of assembly, shipment or installation vs. carrying inventory of multiple CCT's. This can dramatically reduce inventory complexity, lead times and cost. NF2W757G-MT will be available in multiple binning options, including 3-step only, to further simplify the implementation.

Nichia's vision, innovative passion and technical ability has led to this groundbreaking LED development. The excitement within Nichia has truly been matched by the industry over these past 2 weeks. Nichia's unveiling at LpS in Austria was met with enthusiasm and excitement from manufacturers and designers gathering to learn more, as well as recognition from LpS. Nichia received the Best Sustainability Technology Award for 2-in-1 Tunable White LED with Single LES, a back to back awards honor for Nichia (Optisolis™ received LpS Best Lighting Technology in 2018). Feedback from around the world has also been just as strong, including comments such as "This is the most exciting thing from any LED Manufacturer since CSP!!!" and "game changer for sure". Mr. Rick Earlywine, Senior Vice President of Architectural and Downlighting Solutions at Acuity Brands Lighting stated, "Nichia's 2-in-1 LED enables us to deliver a new type of fixture with leading style, performance and color quality. We are excited to be able to launch the first ever product with this breakthrough technology in our new Renna Family. Additionally, we will recognize operational benefits with up to a 90% SKU reduction, while still delivering our full line-up and service promises to our customer."

Nichia's 2-in-1 is now in production, with samples and data available through local Nichia offices. Please contact your local Nichia representative to begin changing the game. ■

## YUJILEDS Releases a New Generation of High Power RGBWW LEDs with High CRI

YUJILEDS lab has announced the state-of-the-art R&D results in the high CRI monochromatic tunable spectrum field. Based on the superposition of spectrum, the new product of 7070 LED, integrated 5 channels - red, green, blue, cold white and

warm white within one packaged LED. The technology is mainly required in photography and film lighting, but also has a potential for any areas that demand various colors or CCTs, like entertainment venue or horticulture lighting.

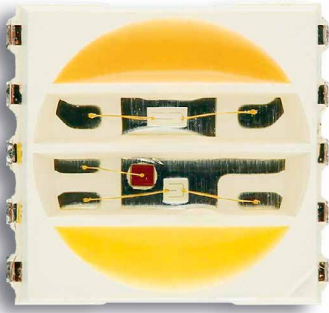

YUJILEDs' new RGBWW 7070 LEDs offer CRI 95+

#### Saturated Monochrome & High CRI:

White light is usually used as a supplement to resolve the low CRI situation when RGB LEDs are applied alone. However, there is still color fading when acquiring other CCTs by tuning the spectrum compared to the original white light. Adding a second white light source provides a further solution to ensure all the white light at CCTs between that of cold and warm white light to obtain the same high level CRI (min Ra 95).

#### Enhanced brightness:

The lead frame of the new LED is designed by Yuji to satisfy the requirement of high luminance. With the current of each channel up to 150mA, the highest output luminous flux could be 43 – 48lm for white and green, 22lm for red and 10.5lm for blue which are 100% higher than conventional 5050 LEDs. Benefiting from the compact integration, it is easier for circuit design and offers the ability for applications requiring high luminance density.

#### Optimized chromaticity consistency:

Powered by the 3rd generation chromaticity technology by YUJILEDs® a detailed introduction can be found in "Less is more - YUJILEDs® releases its 3rd generation of chromaticity bin"), the new LED has an even more reduced bin area and thus better color consistency. Remaining the first-class performance of CRI, it is skilled at fields demanding high color reproduction including photography. With tight wavelength tolerance, it can achieve a more stable CIE gamut, resulting in a more accurate color representation in the "triangle" area.

#### Customization feasibility:

Besides the standard version of red, green, blue, cold white and warm white, the 7070 LED is open for customizing specific color channels. Options are flexible for designers to define their own color combinations for matching different applications. ■

## Xicato - New Daylight 5600 K LED Source

Xicato, the leading provider of smart building wireless controls and highest quality light sources, announced the general availability of Daylight 5600 K CCT. As one of the best approximations of sunlight indoors, it delivers rich, accurate colors with high gamut, CRI 95+ and R9 of 90+, with a consistency and reliability that has set Xicato lights apart.



**The latest member of the Xicato XMT series with 19 mm LES, offers the same outstanding light quality and features as all of its relatives, just in 5600 K daylight white**

#### Advantages of Xicato XTM Modules:

- Drop in replacement for Zhaga LED modules (Book 3)
- Highest efficacy, as much as 20% higher than competitive products
- Next Generation Corrected Cold Phosphor Technology® keeps phosphors cool for maintained light quality
- Same form factor for all flux and CCT options XTM Characteristics:
- Up to over 137 lumens per watt at operating conditions
- Very tight color consistency, within 1 x 2 MacAdam Ellipses
- Standard Series, Artist Series®, Designer Series®, Vibrant Series®, Beauty Series
- CCT range from 2700 K to 5600 K
- Light output 1300 lm to 5000 lm with 19 mm LES and 700 lm to 2000 lm with 9 mm LES
- Zhaga compatible form factor
- Available in 19 mm and 9 mm LES

Xicato's new Daylight 5600 K LED source, part of the popular Artist series, is a perfect

solution for living walls, where the high CCT and high CRI provide just the right amount of plant growth. It is essential in healthcare, rehabilitation facilities and a great choice for livestock lighting for increased production and animal welfare. Photographers and videographers also benefit from the industry's best TLCI values, eliminating the need to perform color correction in post-production.

The Daylight 5600 K is available today in 19 mm LES up to a maximum output of 5,000 lumens, achieving 110 lumens per watt when driven to 5,000 lumens at 1,400 mA. Contact your local Xicato sales representative or authorized distributor for more information and sampling. ■

## Opulent Americas - Linear LED Module with Osconiq S 3030 QD

Opulent Americas, a fully integrated global manufacturer for the lighting, automotive, and medical industries, is excited to announce the product line addition of linear LED modules built with the new Osram Osconiq S 3030 Quantum Dot LED. The Osconiq S 3030 QD was specially developed to enable customers to design luminaires with high efficacy and excellent color rendering for area lighting and downlight.

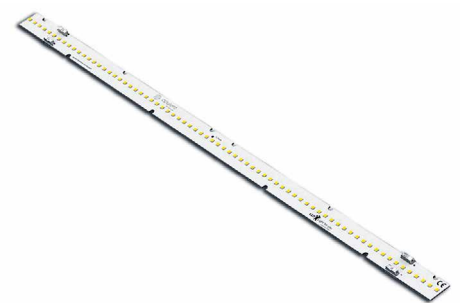

**Opulent Americas' new linear LED module based on Osram Osconiq S 3030 quantum dot technology is ideal for indoor lighting**

The modules come in a 22" configuration that is ideal for panel or linear lights. They are flexible enough to support a range of specialty indoor applications and can be paired with a standard driver for a complete light engine. Designed to Zhaga standards, Opulent Americas' modules are easy to integrate into existing designs and can be quickly upgraded as LED performance improves. ■

## Ledvance- Ultra-Flexible LED Strip Lighting Debuted ELEX Show

New flexible LED Strip lighting made its debut on the Ledvance stand at ELEX Coventry at the Ricoh Arena in September.



The new LED strip lighting portfolio from Ledvance will be on show for the first time at ELEX Coventry, including drivers and accessories in three different categories: Superior, Performance and Value

### New LED Strip lighting:

The new system of ultra-flexible LED strip lighting and accessories from Ledvance covers a wide variety of requirements for professional tailor-made indoor and outdoor ambient, cove or general lighting applications. Available in three categories, superior, performance and value, they differ with regard to ideal application, lifetime, IP rating, number of LEDs per meter and therefore light output and distribution.

With color temperatures ranging from energizing, daylight white 6,500 kelvin to warm white 2,700 kelvin, and lumen packages from 300 to 2,000 lumens per meter, the LED strips are suitable for virtually any lighting task in a modern lighting concept and can achieve a broad spectrum of exciting possibilities. To save time, all Ledvance LED strips are pre-wired on both sides and can easily be shortened if necessary. They also all come as protected and unprotected versions, in other words, with or without a silicone jacket for protection against dust and water.

### Additional highlights at the show include:

The 1906 range of vintage lamps from Ledvance that offer an energy efficient retro look in any room. Using the classic shapes and colors, the Vintage Edition 1906 range create atmospheric decorative lighting yet feature the latest LED technology, offering up to 80% energy cost savings compared to conventional products, and have a life span of 15,000 hours.

The Damp Proof Range of luminaires from Ledvance are ideally suited to dusty and damp locations due to a high IP rating, and provide the three key requirements of professional users: simple installation, excellent efficiency and a long service life. Installation is easy thanks to retaining brackets that can be freely positioned along the length of the luminaire. Electrical installation can be completed without the requirement of tools as the luminaire comes with wiring already preassembled.

Ideal for office buildings, the Ledvance LED Direct/Indirect Panels deliver excellent glare reduction ( $UGR < 19$ ), and a 70% direct and 30% indirect distribution of light. In addition, the microprism structure of the acrylic glass optimizes light diffusion. With a wide range of accessories and add-ons to choose from, the Panel luminaires can be adapted precisely to fit the requirements of each individual office environment.

An exciting range of outdoor luminaires will also feature on the stand, offering simple installation and energy efficient lighting solutions that are weatherproof and robust for outdoor building facades, car parks, gardens, pathways and driveways. The bright and functional outdoor LED luminaires are characterized by an attractive design using high quality materials and a high-end finish, providing an appealing, warm white illumination for a welcoming atmosphere.

The TruSys flexible trunking system from Ledvance offers energy-saving uniform illumination for large areas. This versatile system consists of mounting rails and flat linear lighting inserts that installers can quickly and easily click into position, either mounted on the ceiling surface or suspended. The flexible design of TruSys enables installation as either stand alone or a continuously mounted lighting system in rows of up to 81 luminaires, achieving an overall length of up to 124 meters. ■

## Highly Efficient NFC Programming Method for LED Drivers

For fast and cost-effective implementation of NFC programming for LED drivers, Infineon Technologies AG developed the NFC-PWM series NLM0011 and NLM0010. NFC programming is an emerging

technology designed to replace the labor-intensive "plug-in resistor" current setting method via contactless NFC interface. Besides improving the operational efficiency by enabling automatic programming in the manufacturing line, it creates significant flexibility in the value chain. With this it reduces the LED driver variants, simplifies the selection of LED modules, and allows end-of-line configuration.



Both devices have two operation modes, passive and active mode and offer several common features while the NLM0011 adds an integrated constant lumen output (CLO) function

The devices are NFC wireless-configuration ICs with configurable PWM output, primarily designed for LED applications. They enable cost-effective NFC programming implementation by using a PWM signal directly to control the analog driver IC. Compared to the microcontroller-based solution the system BOM cost is reduced.

Both devices have two operation modes, passive and active mode. In the passive mode, the LED driver module is not powered, and the PWM-related parameters can be configured wirelessly via the NFC interface. In the active mode, as soon as the V<sub>CC</sub> voltage supply is powered, a PWM output is generated according to the stored parameters. With an external R/C filter, the PWM signal is converted to the desired DC voltage to control the current output of an LED driver.

Another highlight feature of NLM0011 is the integrated constant lumen output (CLO) function. This function compensates the luminous flux drop (aging effect) of the LED module by automatically adjusting the LED current to the aging characteristics of the LEDs. With an integrated operation-time counter (OTC) and stored LED degradation curve in the CLO table, NLM0011 automatically adjusts the PWM duty cycle to compensate for the LED degradation.

Perfectly fitting to the mainstream analog

driver ICs, there is no need for firmware development efforts, and it can be easily adopted into existing designs to replace the "plug-in resistor" current configuration concept. Non-volatile memory (NVM) including UID (Unique Identification Data) and 20 bytes free memory for user data is also featured in the devices.

The solution is compatible with existing analog LED-driver designs and the NFC programming specification from the Module-Driver Interface Special Interest Group (MD-SIG). Besides LED power supply applications, the NFC-PWM series can also be used in applications like motor control and SMPS.

The NLM0011 and NLM0010 can be ordered now in a SOT23-5 package. ■

## Inventronics - Next Generation Platform, IP66/IP67 LED Driver Family with UL Class P

Inventronics has introduced an entirely new family of programmable, IP66/IP67 LED drivers designed with a next generation platform. They provide OEMs even more design flexibility with UL Class P, a more compact housing and industry-leading surge protection.

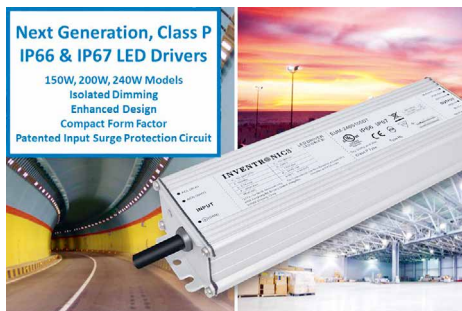

**Inventronic's new generation of EUM-DT LED drivers are optimized to lower costs while maintaining performance and quality of the ancestors**

The EUM-DT family is designed with the latest, next generation platform equipped with an enhanced transformer design, optimized components that provide lower costs without sacrificing quality or performance and a new design methodology to support a warranty Tc of 80°C. They are highly reliable, and their robust protection allows for longer lifetimes up to 106,000 hours.

Each series provides a multi-layer of protection which includes over-voltage, over-temperature, and short-circuit protection. Utilizing a new proprietary circuit, the drivers are still able to maintain an industry-leading surge protection of 6 kV (differential mode) and 10 kV (common mode) while passing typical hi-pot testing for luminaires without any secondary operation. The rugged, extruded-metal housing, which utilizes a proprietary encapsulation process, is IP66 and IP67 rated and specially designed to operate in demanding applications such as high bay, high mast and roadway lighting.

The EUM-DT family also allows for extreme design flexibility. They are UL Class P Listed providing the freedom of substitution without new testing and bring your products to market faster. Their programmable interface and constant-power operation allow for in-house customization which achieves optimal results and various current configurations without the need of powering on the driver. They offer 3 constant-power, programmable series delivering 150 W up to 240 W at output currents from 700mA to 6700mA with more power levels releasing later this year. Their ultra-compact design is smaller than previous generation Inventronics drivers, allowing them to fit inside a multitude of luminaires.

The EUM-DT family supplies improved safety with a wide range of isolated dimming options to remain compliant with all standards including the new UL May 2020 requirements. These dimming controls include isolated 1-5 V, 1-10 V, PWM and multiple timers. v

## GlacialPower - New GP-CVP040N Series LED Constant Voltage Driver with TRIAC Dimming

GlacialPower, the power division of the LED technology manufacturer GlacialTech Inc, announces the new GP-CVP040N series LED constant voltage driver. It is available in 12 V DC and 24 V DC output rated power of 40.8 W. The driver supports TRIAC dimming function, and appropriates for LED strips application in places such as restaurants, jewelry shop, home and theater.

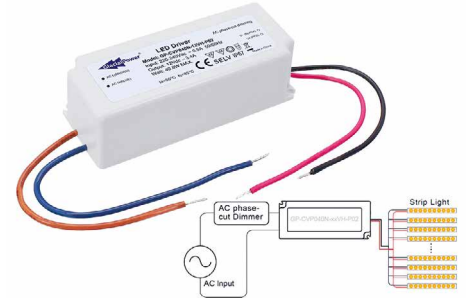

**GlacialPower's new GP-CVP040N series LED constant voltage driver for LED strips applications provides a TRIAC dimming function**

### Features:

- AC input range from 205 to 256 V AC
- Constant voltage mode
- Work with leading edge and trailing edge TRIAC dimmers
- AC phase-cut dimming
- IP67 rated
- Safety protections include OVP, OCP, SCP, and OTP
- Appropriate for LED strips application
- 2 Years warranty
- RoHS compliant

The dimming adjustment output of the GP-CVP040N series LED driver ranges from 5% to 100%. Works with leading edge and trailing edge TRIAC dimmers. The typical power conversion efficiency is 82% for 12 V and 84% for 24 V. It supports an AC input voltage range from 205 to 256 VAC.

The fully isolated case design enables an operation temperature range of -20°C to 45°C, which means that the LED driver can be used in most environments. Additionally, with IP67 approval as well as four different protections: Over-Voltage Protection (OVP), Over-Current Protection (OCP), Short-Circuit Protection (SCP) and Over-Temperature Protection (OTP), these drivers are highly secure. ■

## EPtronics Announces LD96W-TL High Power LED Driver for Phase Dimming Applications

EPtronics, Inc. (EPtronics) has announced a new addition to its high-power Class 2 LED driver offerings: the latest generation LD Series LD96W-TL driver with high performance constant current output. This dimmable LED optimized driver provides the perfect solution for new and

retrofit applications requiring high power output in a single unit, removing the need to divide light engines across multiple lower wattage drivers. Designed to operate with TRIAC and ELV phase dimming input, the EPtronics line of -TL phase dimmable drivers includes 6 W, 9 W, 12 W, 16 W, 20 W, 25 W, 40 W, and now this 96 W model.



EPtronics added a 96 watt model to its series of TL phase dimmable drivers

EPtronics, a leading manufacturer of solid-state lighting power products, offers the broadest selection of UL listed and recognized off-the-shelf LED drivers. Our US-engineered products ensure exceptional performance and reliability to satisfy your technical requirements. All EPtronics products are protected by a standard 5-year limited product warranty.

## Code Mercenaries - New Approach to Configure (DALI) Buses

DALI is a well-established option for lighting control in SmartHome and SmartBuilding applications. Costs for DALI components have dropped in recent years and the selection of components has grown significantly. Though the configuration of the bus remains a challenge for the installers. The cabling is quite different from classic cabling since the bus has to run parallel to the power line. But the major problem is the usually very complicated deployment software for setting up the configuration of the bus components.

Currently available products for the bus configuration either require too much detailed knowledge of the bus protocol or are limited in the configuration options. Some are specialized for the parts of certain manufacturers, which reduces their usability for installations with parts from multiple companies.



While BusMaster requires LED-Warrior14U-DR, it makes the typically complex DALI programming a breeze by hiding the DALI protocol as much as possible

BusMaster by Code Mercenaries changes the user paradigm. The complexity of the DALI protocol is hidden as much as possible and typical configuration steps have much simplified handling while retaining the full flexibility of detailed configuration options.

One of the typical stumbling blocks in DALI deployment is readdressing of luminaries. BusMaster displays all addressed devices in an 8 x 8 matrix and allows simple drag&drop to move a device to a new address or make it switch addresses with another device. Clicking a device in the matrix locates this device by dimming it to 100%. Multiple devices can be selected in the matrix to simultaneously change their settings. Settings can be stored and copied to other devices too. This significantly speeds up the configuration.

Group assignment of the devices is also very comfortable with BusMaster. A dialog shows all devices and groups in a matrix and allows assignment by just clicking. This makes the group memberships of devices visible as pattern.

BusMaster requires a LED-Warrior14U-DR by Code Mercenaries and a computer running Windows 7 or newer. The license for BusMaster is included with the purchase of LED-Warrior14U-DR. ■

## Upwertek New DALI-2 Certified LED Drivers

Upwertek began converting its existing DALI LED driver portfolio to DALI-2, and more products will follow. The new driver with DALI-2 certification brings the promise of significantly improved multi-vendor interoperability as well as functionality compared to DALI-1.

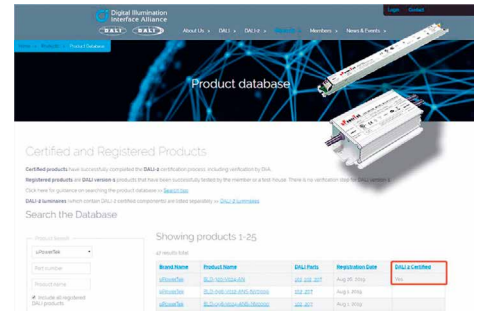

DALI registered products are listed on the DiiA website and products that successfully completed the DALI-2 certification process are marked

Upwertek DALI dimmable LED drivers have the following characteristics in common:

- Great surge immunity 10kV
- 100,000 hour life @  $T_c = 75^\circ\text{C}$
- 7 Year Warranty @  $T_c \leq 75^\circ\text{C}$
- Dim off with 0.5 W standby power
- Short circuit, over temperature, overload protection
- NFC programmable
- DALI-2 dimmable
- Additional benefits include:
  - More energy efficient lighting
  - Easier customization
  - Reduced installation costs

The DALI-2 standard, the latest version of the IEC 62386 standard for DALI technology, is administered by the Digital Illumination Interface Alliance (DiiA) which certifies that products that carry the DALI-2 logo are compliant with the standards' protocols.

The DALI-2 certification program was launched on August 28, 2017 as a result of the dedicated and ongoing collaborative effort by DiiA member companies.

DALI-2 certification, which allows the product to carry the DALI-2 logo, indicates compliance with the relevant parts of version 2 of IEC 62386, the international DALI standard.

While DALI-1 revolutionized options for regulating artificial lighting, DALI-2 is helping fill the gaps in the original standard. Not only does it allow for more interoperability with other wireless protocols such as Bluetooth, Wi-Fi and Zigbee, it also adds a host of new functions previously unavailable.

Upwertek DALI dimmable LED drivers passed ENEC, UL class P, CCC, CE, RCM and CB certification, available from 30 watt to 600 watt, constant current or constant voltage output, ■

## New COB Holders from Bender + Wirth Using Micanite

The new Bender + Wirth COB Holder Hybrid 630 combines the design flexibility of injection molding with a superior thermal performance because of a "Heart of Stone". - They feature micanite to achieve this unmatched performance.



Bender + Wirth's 630 series offers 5 different standard housings

Much like the 430 series, the 630 holder is a modular concept designed to accommodate an infinite combination of COBs and optics. The program will start with 120 different variations.

The holder improves the heat transfer from the COB to the heat sink and thermally disconnects the optics. Because of the mechanical integrity of micanite, the COB actually operates at a lower temperature which helps prevent premature LED failure.

Clip in function and push in terminals make the holders convenient for high levels of production. The automated assembly of the holder generates cost benefits. ■

## nanoLambda XL-500 - Tiny Spectroradiometer - Find Optimum Spectrum

nanoLambda, No.1 spectral sensor company, announced XL-500, a tiny BLE spectroradiometer with free Android and iOS apps, designed for lighting researches and industrial uses in plant, animal and human centric lighting fields.

The XL-500 measures and records light spectrum with absolute power values, such as SPD ( $W/m^2/nm$ ), PAR/PPFD ( $\mu mol/m^2/s/nm$ ) and Lux ( $lm/m^2$ ).

Also CCT (K), CRI, and CIE values for color are measured. nanoLambda packed all these functions with rechargeable battery and Bluetooth Low Energy (BLE) into a light weight and compact size (28g @ 39x26x16 mm). Users can set the measurement period and interval to

measure the light spectrum continuously over a few weeks at one battery charge.



nanoLambda's XL-500 measures and records light spectrum with absolute power values including SPD, PAR, lux, plus CCT, CRI and CIE

Recently, a leading human-centered lighting research group at the École Polytechnique Fédérale de Lausanne (EPFL) and University of Basel in Switzerland, and University of Oxford in UK, published a research paper, "What is the 'spectral diet' of humans?" where the team used XL-500 as a wearable sensor. Large-scale projects using hundreds of XL-500(s) to collect big data sets over the real world are their next steps.

nanoLambda was also selected as one of 9 startups in the GROW Agri-Food Tech Accelerator program in Singapore. "XL-500 will be very useful in agriculture industry," said Bill Choi, CEO of nanoLambda, "enabling to find out the right recipe of spectrum and monitor the effective spectral nutrient for different plants at different growth phases, to improve yield and quality." XL-500 is available online for purchase, along with other spectral sensor products for various nondestructive or noninvasive sensing applications. ■

## Accurate Sub-Nanometer Resolution Wavelength and Power Measurement

Gamma Scientific announces the release of the Wavemon™ wavelength and power meter. The unit delivers accurate, real-time wavelength data combined with power measurement at a fraction of the cost of

traditional spectrometers. Using proprietary optical filtering techniques and onboard calibration data, the Wavemon is able to resolve wavelength with accuracies to +/- 0.25 nm and +/- 0.01 nm repeatability and irradiance absolute accuracy of +/- 1%.



With its extremely high accuracy, Wavemon™ is perfectly suited for wavelength and power measurement of traditional laser sources, VCSEL devices, and LED's

The Wavemon is particularly well-suited for wavelength and power measurement of traditional laser sources, VCSEL devices, and LED's. Real-time monochromator wavelength monitoring is also readily achievable. Ideal for test and characterization, the product is compatible with continuous-wave and pulsed sources from 365 nm to 1,100 nm, with short-wave infrared options.

High dynamic range is achieved using a transimpedance amplifier with 5 gain ranges, and rock-solid stability via temperature stabilized detectors and optical filters. The compact unit is particularly well suited for laboratory and production environments and comes standard with a USB 2.0 interface and drivers for Windows®, macOS, and Linux. Calibration per ISO 17025 accreditation is also available. ■

## Hyperspectral Video Camera with Excellent Data Quality, Flexibility and Speed - ULTRIS Q20

Cubert's new ULTRIS camera was developed based on the light field technology. The camera features an Ultra-HD CMOS sensor with 20 MP, which makes ULTRIS the imaging spectrometer with the world-wide highest resolution. During image acquisition the object is recorded with a multitude of images, each with its own optical bandpass filter with different center wavelength.





**ULTRIS Q20 is the imaging spectrometer with the world-wide highest resolution, and still fast and flexible**

The camera provides a native image resolution of 400 x 400 px with 100 spectral channels, continuously covering the wavelength range from 450 nm to 850 nm, acquiring 160,000 spectra simultaneously, non-scanning.

The 12-bit sensor of the camera makes it possible to detect minute intensity differences in the spectral content while keeping the noise level very low. The dual GigE camera interface guarantees an image frame rate of 6 Hz.

ULTRIS S20, with its 410g is one of the most lightweight cameras on the market, making it ready for an easy handling on board UAVs. ULTRIS Q20 was designed to fulfill the requirements of an industrial environment and can be used with a ruggedized housing for IP 65 or IP 68 environments. Therefore, it is ideal for industrial applications like sorting, process control and QS, as well as for scientific applications in agriculture, forestry, soil sciences and many more. ■

## BTS256-EF Measures New Flicker Metrics for Compliance with Ecodesign Directive

The European Commission's proposed regulation of lighting under the Ecodesign Directive will establish mandatory product performance and quality requirements on all lighting products. This new EU directive will include strict requirements for flicker and stroboscopic effect, collectively referred to as temporal light artefacts (TLA). Simple measures such as flicker index and modulation depth will not be adequate as they do not distinguish the possible TLA effects and do not account for the effect of frequency-dependent sensitivity or the wave shape of light output. The BTS256-EF

spectral light and flicker meter measures the specific metrics required by the regulation, PstLM and SVM.



**BTS256-EF comprehensive photometric and colorimetric measurements plus PstLM flicker and SVM stroboscopic metrics**

The metric used for flicker in the Ecodesign regulation is the parameter 'PstLM', short-term flicker severity, where a value of PstLM=1 means that the average observer has a 50% probability of detecting flicker. The metric used for stroboscopic effect in this regulation is 'SVM', stroboscopic visibility measure, where SVM = 1 represents the visibility threshold for an average observer.

The limits in this new EU directive are currently discussed to be PstLM < 1.0 and SVM < 0.4 although there is lobbying from the lighting industry to relax the SVM limit to <1.6. Regardless, meeting these demanding limits, particularly for SVM, will require considerable effort by manufacturers prior to the September 2021 enforcement date.

Besides full TLA measures, the BTS256-EF in conjunction with its provided software provides comprehensive photometric and colorimetric data required for general lighting applications. Additional functions are also provided for specialist tasks such as horticultural and human centric lighting. ■

## New Stray Light Correction Method Enables UV Hazard Measurements with Array Spectroradiometer

A new stray light correction method implemented in the BTS2048 UV array spectroradiometer now enables applications previously only possible with double monochromator systems. This novel method was presented at the CIE's 29th quadrennial session. It combines Out-of-Range and

In-Band stray light correction techniques, thereby greatly increasing the dynamic range of accurate UV measurements.

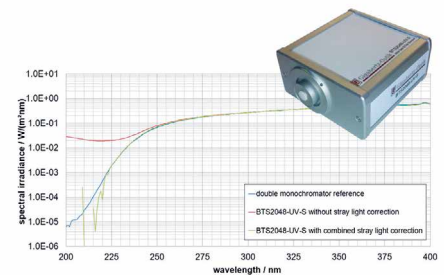

**BTS2048 devices benefit from new stray light correction method**

This performance is particularly beneficial for the assessment of UV hazards in accordance with the measurements required by IEC/DIN EN 62471, EU Directive 2006/25/EC and ICNIRP guidelines. The compact BTS2048-UV-S is convenient for in-situ measurements as well as laboratory-based setups. This hybrid stray light correction method has been incorporated into the latest S-BTS2048 software. ■

## New Photometric Detector for Very Low Illuminance Measurements

To meet the demands of the increasing number of very low light level applications, Gigahertz-Optik has introduced the VL-3707 precision photometric detector capable of accurate measurements down to less than 100 µlux.



**Luxmeter for very low illuminance levels consisting of optometer P-9710 with photometric detector head VL-3707**

For example, the VL-3707 is suitable for testing and characterizing night vision equipment used in surveillance, security and automotive applications. The measurement of moonlight and starlight (mlux to µlux)

enables research on light pollution of the night sky. Emergency lighting standards (e.g. DIN EN 1838 and ISO 30061) require measurement resolution in the mlux range.

The VL-3707 incorporates a latest technology photodiode, high transmission photometric filtering, and a cosine diffuser to create a highly sensitive illuminance detector. Used in conjunction with the Gigahertz-Optik P-9710 Optometer, the VL-3707 provides a sufficiently high signal-to-noise ratio for reliable measurements even in the 100 µlux range. ■

## Ledvance Announces Panel 1200 Direct/Indirect for the Perfect Work-Light-Balance

The new Panel 1200 Direct/Indirect is a suspended edge-lit, stand-alone luminaire with direct (70%) and indirect (30%) light emission. It therefore provides the right lighting for a variety of office requirements in line with relevant office norms. The new luminaires for the Panel 1200 series follow the unified and award-winning Ledvance Scale design language.

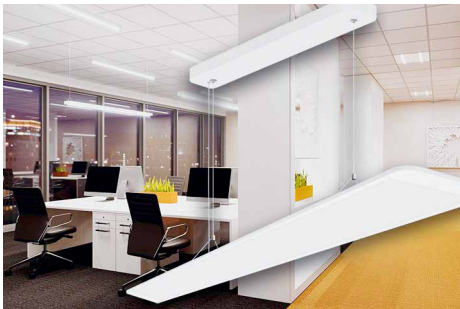

The new Panel 1200 Direct/Indirect series from Ledvance provides flexible, low maintenance lighting for a variety of office requirements

Lighting systems for office buildings have to comply with numerous standards, directives, laws and guidelines and have to take into account different health and safety requirements as well as scenarios depending on the architecture, usage and area size. Key demands include widely glare-free light for screen-based work, uniform distribution of light and adequate illuminance. Only suitable lighting solutions that are ergonomically well-designed can create a productive working environment, help to enhance the employees' concentration and thus offer benefits for companies in every

sector. With the new Panel Direct/Indirect, Ledvance launches a luminaire series that meets these specific requirements.

### High quality of light - low maintenance and operational costs

The new Panel 1200 Direct/Indirect luminaires deliver 70 percent direct light for the workplace and 30 percent indirect light for basic illumination with a luminous flux up to 4,000 lumens (2,800 lumens down / 1,200 lumens up). Thanks to the micro-prismatic high transmission PMMA light guide, a homogenous and controlled light distribution is provided. Thus, a Unified Glare Rating less than 19 (UGR<19) in accordance with the norm UNI-EN 12464-1 can be achieved. The luminaires of the new series cause low maintenance and operational costs due to a good luminous efficacy of up to 110 lumen per watt and a lifespan of up to 80,000 hours (L70/B50). Further, the included driver is integrated in the canopy, which leads to more flexibility in case a change is necessary. The Panel 1200 Direct/Indirect luminaires are also available with DALI electronic control gear as an option. Ledvance grants a guarantee of five years for all luminaires of the new Panel series.

### Minimalist, functional design and easy installation

The Panel Direct/Indirect series follows the modern SCALE design language by Ledvance, winner of the German Design Award 2019 in the Light category. The luminaire is very slim and features sleek high-quality styling with an aluminum frame and rounded edges. The transparent electrical cables can be easily wired thanks to fast-connectors. Additionally, the suspension steel-wires allow to position the luminaire on the required height. ■

## Magnetic Brilliance: CLICK – the New Light Design by Kolarz

Autumn is just around the corner: It's the perfect time for more light in our homes, especially for focused accents creating atmospheric effects of light and shadow. The new CLICK by Kolarz is a functional contemporary ceiling light, extremely flexible in use, easy to mount and available in a great variety of hand-finished surfaces: in a purist black or white design, in a sleek and stylish

gold, silver or copper leaf look or in a Vintage metallic style, also showing finest gold, silver or copper leaf.



The new CLICK by Kolarz is available as a circular or squared single light, as a circular 3-flamed ceiling light or as a squared 4-flamed ceiling light

### Magnetic, functional, brilliant

CLICK has a magnetic corpus that is easily placed onto the frame of the lighting object. So the look of this stylish ceiling light can be changed within a minute: from white to black, from black to white, from copper to silver, from silver to gold. The dimmable, exchangeable LEDs (GX53) create brilliant light as well as a cozy ambiance, with 560 lumen per lamp and a light color of 2,700 Kelvin. ■

## eLumigen Launches LED Vapor Tight Linear Lowbay Fixtures

eLumigen launched their new 4' LED Vapor Tight Linear Lowbay fixtures. The new LED Vapor Tight Linear Lowbay fixtures come with an extremely durable housing, including an IK10 protection rating to withstand up to 11lbs of impact. The fixtures have an IP66 rating for dust & water ingress protection for both indoor and outdoor applications. A flip-down cover at each end creates easy access for through-wiring and daisy-chaining multiple fixtures together.



eLumigen's new LED Vapor Tight Linear Lowbay fixtures have an IP66 rating for dust & water ingress protection for both indoor and outdoor applications

These newest eLumigen fixtures are lightweight, only 5.3 pounds, for easy installation. Their rigid diffuser has anti-yellowing technology, low glare, and a wide beam angle for optimal illumination. DLC Premium certification means that the fixtures meet the very highest standards for energy efficiency, at 125 lumens per Watt. The drivers have thermal protection and 0-10V dimming capability.

The LED Vapor Tight Linear Lowbay fixtures come in two models, one 34W with 4800 lm and a 50 W model with 6500 lumens. Both models are 4000 K CCT, universal voltage, and 80+ CRI. Alfred LaSpina, VP of Sales & Marketing at eLumigen states, "The LED Vapor Tight Linear Lowbay fixtures have been requested by our industrial customers and we have given them even more than they asked for." LaSpina added, "We haven't seen any other LED Vapor Tight Lowbay in the market with the combination of DLC Premium, IK10, and IP66 certifications." ■

## Ledvance Expands Its Portfolio of TruSys Trunking Systems

With the extension of the portfolio by the new TruSys Performance, LEDVANCE expands its wide range of attractive lighting solutions for factories, workshops and warehouses even further. The luminaires in the TruSys Performance series offer a very high system efficacy and life span, as well as quick and easy installation and a good price-performance ratio. LEDVANCE has launched the TruSys PFM On/Off and the TruSys PFM DALI in September 2019, the TruSys PFM EM, the emergency version, will follow in December 2019.

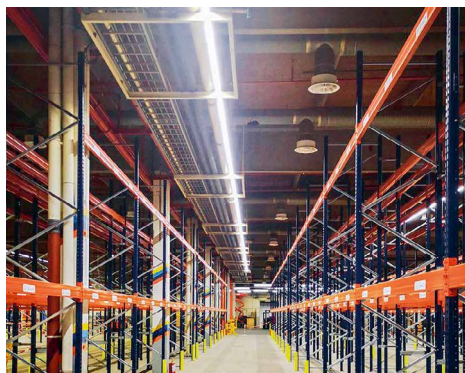

Ledvance adds TruSys Performance to its range of advanced lighting solutions for factories, workshops and warehouses

### Three different models

The expansion of the existing TruSys product family consists of the three different models TruSys Performance On/Off, TruSys Performance DALI (Digital Addressable Lighting Interface) and the TruSys Performance EM (emergency). All of the new luminaires generate up to 11,200 lumens with a colour temperature of 4,000 K. Additionally, they have a very high system efficacy of up to 160 lumen per watt and an above average lifespan L80/B10 with up to 60,000 hours. The TruSys Performance DALI model is dimmable and offers the possibility to add connectivity and intelligence to the luminaires as they can be extended with external presence and daylight sensors, enabling daylight and occupancy-dependent operation. This version is compatible with a central battery system for emergency lighting. The TruSys Performance EM provides an emergency lighting option for self-contained operation, and is applicable as single luminaire solution designed for three hours of operating time in the event of a power failure. Ledvance provides a three-year guarantee for all three models.

With four beam angles (very wide 120°, wide 90°, narrow 60°, very narrow 30°) and three different lumen packets (5,600 lm, 8,000 lm or 11,200 lm) the TruSys Performance series can cope with different heights up to 10 meters in industrial buildings as the luminaires provide the required illuminance and uniformity defined in the process of lighting. Trunking system luminaire modules featuring narrow-beam optics, for example, can be used in high-bay warehouses with high ceilings to illuminate the shelf fronts with at least 200 lux on average, while wide-beam optics are ideal for workshops or factories with low ceilings as they provide uniform illumination.

### New features offer even more advantages

The new Ledvance TruSys Performance portfolio offers various additional advantages. It does not only convince with a great price/performance ratio, but also by an even easier mounting and dismounting. Like the existing trunking system from Ledvance, the Performance models also consist of mounting rails and extremely flat linear luminaires, which can be quickly clicked into place – as a continuous or intermittent lighting strip. The difference lies in the material of the housing and the diffuser. The housing of the existing

luminaires portfolio is made of lightweight anodized aluminum, the housing of the new models comes in high-quality steel sheet. Also, the material of the diffuser has been upgraded from PC to tough and lightweight PMMA, resulting in a better performance in terms of UV-resistance and efficiency.

### Matching energy rail and accessories

Besides the three versions of 1.5 meters long high-quality luminaires, the new Ledvance TruSys Performance portfolio also consists of matching 1.5 and 3 meters long energy rails and a selection of the most frequently used accessories. A well-organized cable system, with 5 and 8 pole options, as well as a mechanical and electrical connector for easy mounting are included in the energy rail. Part of the Performance portfolio are also two 1.5 meter energy rails (END), and 5 and 8 pole, to close a line seamlessly. The set of accessories consists of different types of quick-fix brackets for mounting rails on ceilings or grid ceiling surfaces, as well as adjustable ropes or brackets, plus hooks for the suspension mounting of energy rails. The mounting brackets are recessed in the rails and therefore almost invisible from the outside, which adds to TruSys' clean appearance. Blind covers serve the purpose to cover a gap in the light row. ■

## GlacialLight Announces New Natural Sunlight of AR111 Series with 3-in-1 and TRICA Dimming

GlacialLight, the LED lighting division of GlacialTech Inc., announces the natural sunlight GL-AR111-V2A-12-NL series. With a CRI of 97, as well as the CQS (Color Quality Scale) is up to 98. The color fidelity index (TM-30-15 Rf) and color gamut score (TM-30-15 Rg) are close to natural sunlight.



GlacialLight's new Natural Sunlight AR111 Series with 3-in-1 and TRICA dimming, GL-AR111-V2A-12-NL offers high color rendering index 97

**Features:**

- High CRI is 97
- High CQS is 98
- TM-30-15 Rf is up to 97
- TM-30-15 Rg is up to 102
- 3-in-1 dimming and AC-TRIAC dimming functions optional
- Optional square gimbals housing kit and round single housing accessories

It also features with two dimming functions include AC-TRIAC dimming and 3-in-1 dimming for greater lighting flexibility. The GL-AR111-V2A-12-NL is well suitable use for spot lighting, residential lighting, commercial lighting, hallway lighting and cabinet lighting.

The GL-AR111-V2A-12-NL is compatible with the round single housing and square gimbals housing kit. The AR111 square gimbals housing kit features a dual ring gimbals system for two degrees of rotational freedom, making it a flexible lighting solution for any space. It also offers single fixture, double fixture, triple fixture and quadruple fixture for a variety of interior lighting applications including hotels, restaurants, and department store.

The natural sunlight GL-AR111-V2A-12-NL with high color rendering index 97 produces a continuous spectral distribution across all wavelengths and no color gaps, just like the spectral distribution of sunlight. It is uniquely designed with full spectrum technology that you can see each color as nature light and always real. ■

## Chinese Researchers - Method to Overcome Low Efficiency of HiP Flip-Chip LEDs

Chinese scientists from different research centers recently published a co-authored paper on "Highly Efficient GaN-based High-Power Flip-Chip LEDs" in Optics Express Vol. 27, Issue 12, pp. A669-A692 (2019) under the terms of the OSA Open Access Publishing Agreement. High-power flip-chip light-emitting diodes (FCLEDs) suffer from low efficiencies because of poor p-type reflective ohmic contact and severe current crowding, they propose an improvement by using an Ag film.

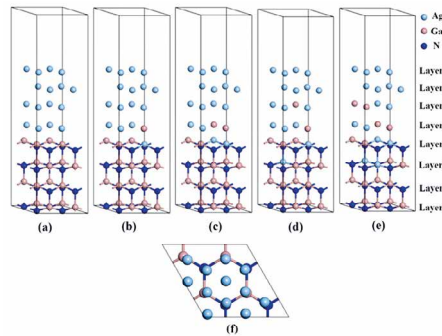

**Five interfacial composition configurations were considered and corresponding atomic structures of Ag/GaN interface are shown in this image**

**Abstract:**

In this paper, the authors show that it is possible to improve both the light extraction efficiency (LEE) and current spreading of an FCLED by incorporating a highly reflective metallic reflector made from silver (Ag). The reflector, which consists of an Ag film covered by three pairs of TiW/Pt multilayers, demonstrates high reflectance of 95.0% at 460 nm at arbitrary angles of incidence.

The numerical simulation and experimental results reveal that the FCLED with Ag-based reflector exhibits higher LEE and better current spreading than the FCLED with indium-tin oxide (ITO)/distributed Bragg reflector (DBR). As a result, the external quantum efficiency (EQE) of FCLED with Ag-based reflector was 6.0% higher than that of FCLED with ITO/DBR at 750 mA injection current.

The work also suggests that the EQE of FCLED with the Ag-based reflector could be further enhanced 5.2% by replacing the finger-like n-electrodes with three-dimensional (3D) vias n-electrodes, which spread the injection current uniformly over the entire light-emitting active region. This study paves the way towards higher-performance LED technology. ■

**References:**

The original paper is published and under copyright of © 2019 Optical Society of America under the terms of the OSA Open Access Publishing Agreement and can be downloaded at [www.osapublishing.org/](http://www.osapublishing.org/)

**Credits:**

Shengjun Zhou, Xingtong Liu, Han Yan, Zhiwen Chen, Yingce Liu, and Sheng Liu, "Highly efficient GaN-based high-power flip-chip light-emitting diodes," Opt. Express 27, A669-A692 (2019).

## Study Reveals How Age Affects Perception of White LED Light

Although LEDs are increasingly used in low-energy lighting and displays, consumers sometimes find their light harsh or unpleasant. Findings from a new study point to the need to take age-related perception differences into account when designing white LED lighting that is more pleasing to the eye.

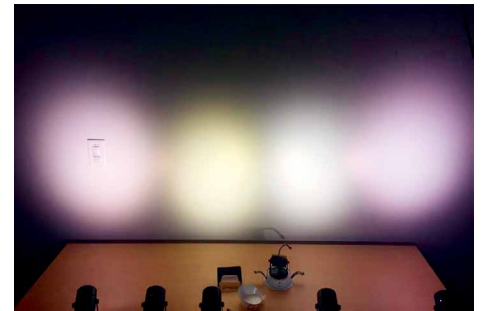

**Designs that consider color perception differences could improve LED lighting (Credit: Sora Inc., Fremont, Calif., U.S.A):** A new study reveals that age can affect the perceived tint of white light. This photo shows a very large difference in tint between different spots, which is representative of what the researchers found in the study. Though not representative of what all observe, viewers of different ages disagree on which of these sources appears "most white" when compared to a reference source (here, the digital camera taking the photo selected the third spot for white balance)

"Our study revealed that the amount of short-wavelength light a source emits together with the viewer's age may lead to very different perceptions of a white light," said the research team leader Aurelien David of Sora Inc., Fremont, Calif., U.S.A. LED light sources exacerbate this effect, because their emission often features large peaks of blue or violet radiation."

The researchers report the new findings in The Optical Society (OSA) journal Optics Express. They point out that although conventional colorimetry assumes all users have the same visual response, more recently developed models for color perception take age-related effects into account and can be used to predict and help mitigate differences in color perception.

"Today, the color of light is defined by standards based on decades-old science that doesn't accurately predict color perception," said David. "This presents a hurdle to designing better light sources that



# LUXEON MultiColor Module 2.5W

Achieve breakthrough flux and exact color points  
for architectural and outdoor lighting



LUXEON MultiColor Module 2.5W from Lumileds is a 4-in-1 module which combines red, green, blue and white emitters in a compact 5050 footprint to ensure brilliant color designs in a variety of outdoor lighting applications. The module can be driven at up to 240mA for breakthrough lumen output and is designed to enable seamless color mixing and eliminate problems of crosstalk.

## Key Features

- RGBW 4-in-1 module
- 5mm x 5mm
- Individually control each channel

## Key Applications

- Decorative
- Linear
- Wall Grazer
- Wall Wash

To find out more on the LUXEON Multicolor Module 2.5W,  
visit [FutureLightingSolutions.com](http://FutureLightingSolutions.com) or contact your local FLS representative.

would minimize inter-user variation and aid in the increased use of LED technology."

#### Testing white light perception

For the study, viewers were shown several nearly white LED sources with various emission spectra and asked to rank their perceived tint compared to that of a reference white light. The test sources were part of the researchers' efforts to develop a more sleep-friendly light source. They featured a specialized emission spectrum in which the short-wavelength blue light, which may affect sleep, was replaced with shorter-wavelength violet light that maintains the light's white color.

"According to standard colorimetry methods, all users should have the same perception for a certain LED source," said David. "However, we found large variations between viewers. Some thought a given source appeared very pink, whereas others thought the same source appeared very green."

Analysis of these findings revealed that the perception variations were largely driven by age. Turning to modern color science, the researchers were able to derive a perception model that accurately accounted for the inter-user perception variation they observed.

"The perceived tint of these unusual LED sources is heavily influenced by the viewer's sensitivity in the violet range, which is strongly age-dependent," explained David. "Although others have observed similar variations in white-LED perception, the effect was especially easy to see because these special LEDs exacerbate it."

The researchers also showed that the age-dependent perception effects are present in conventional LEDs such as those used both in lighting and display applications. This means that two conventional LED sources that supposedly have the same white color may appear very different to a given observer.

#### Defining new color standards

"By using modern colorimetry, the design of future LED sources could be tailored to minimize inter-viewer discrepancies," said David. "Manufacturers could use this modern framework to design lighting that is more robust against age-driven variations."

The researchers note that having a standard calculation for age-dependent colorimetric quantities would help manufacturers and other stakeholders incorporate age-dependent effects into the design of future LED emitters.

"We should make sure that such age-related effects do not hinder the advancement of LED technology, since they can be addressed with scientific tools that are already available, albeit not commonly used," said David. ■

#### Acknowledgements:

The researchers acknowledge that all 64 subjects used for this research were all employees of Sora Inc. who volunteered to participate in the study.

#### References:

Paper: A. David, D. Sahlhoff, M. Wisser, "Human perception of light chromaticity: short-wavelength effects in spectra with low circadian stimulation, and broader implications for general LED sources," *Opt. Express*, 27, 22, 31553-31566 (2019). DOI: <https://doi.org/10.1364/OE.27.031553>

#### About Optics Express:

Optics Express reports on scientific and technology innovations in all aspects of optics and photonics. The bi-weekly journal provides rapid publication of original, peer-reviewed papers. It is published by The Optical Society (OSA) and led by Editor-in-Chief James Leger of the University of Minnesota, USA. Optics Express is an open-access journal and is available at no cost to readers online at OSA Publishing.

#### About The Optical Society:

Founded in 1916, The Optical Society (OSA) is the leading professional organization for scientists, engineers, students and business leaders who fuel discoveries, shape real-life applications and accelerate achievements in the science of light. Through world-renowned publications, meetings and membership initiatives, OSA provides quality research, inspired interactions and dedicated resources for its extensive global network of optics and photonics experts.

For more information, visit [www.osa.org](http://www.osa.org)

## Plessey - Native Blue and Native Green Emission microLEDs from the same Wafer

Plessey, an embedded technologies developer at the forefront of microLED technology for augmented and mixed reality (AR/MR) display applications has extended the capability of their proprietary GaN-on-Silicon process to enable Native Blue and Native Green emission from the same wafer.

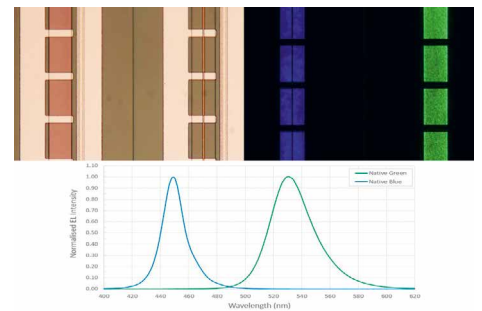

#### Plessey's unique, proprietary GaN-on-Silicon process enables Native Blue and Native Green emission from the same wafer

The potential of microLEDs is well known but several challenges remain before ramping up to large scale consumer applications. To form RGB microLED displays, typical approaches are to use a pick and place process to transfer discrete R, G and B pixels or to use Native Blue LEDs as the light source for subsequent color conversion, to Red and Green.

Plessey's latest patented growth approach creates both Native Blue and Native Green emission layers on the same wafer. The monolithic formation of two colors significantly simplifies display manufacture. Green microLEDs have high efficiency with a narrow spectral width resulting in an excellent color gamut when operating alongside the high performance Blue microLEDs. Plessey's new approach forms microLEDs that exhibit high current density operation and long operational lifetime.

The monolithic integration of both the native Blue and Green microLEDs on the same Silicon substrate is the result of a concerted effort aimed at solving several challenges previously considered insurmountable. Among the issues preventing the integration of multiple wavelength diode junctions are, firstly, a magnesium memory effect and diffusion from the p-type cladding of the lower junction into the upper junction.

An additional process challenge to the integration of Blue and Green microLEDs is the precise tuning of the thermal budget during the growth of the second junction to prevent indium phase separation in the blue active region. Plessey has precisely engineered the thermal budget to maintain high efficiency (IQE), low defectivity and high electrical conductivity required for high brightness display applications.

A final operation in the formation of GaN microLEDs is a post growth treatment aimed at removing hydrogen atoms that would otherwise compromise the conductivity of p-type layers. The presence of a second junction complicates the removal of hydrogen from the buried device structure negating the effect of standard post-growth activation treatments.

Plessey has successfully overcome all these challenges and created a monolithic Blue and Green microLED fabrication process that integrates these junctions vertically separated by a sub-micron layer thickness and results in very reproducible and stable diode performance, well beyond what is typical in the LED industry.

Dr Wei Sin Tan, Director of Epitaxy and Advanced Product Development said: "Our latest breakthrough has a multiplier effect on our previous successes with high efficiency monolithic native blue arrays, native green arrays and hybrid bonding to backplane by demonstrating a way to synthesize the best of our know-how into a single die.

This has enormous implications and will open the doors towards new innovations across a wide range of display applications. For mobile and large displays, a high efficiency single RGB tile can now be used for mass-transfer and for micro-displays, this creates a path to the elusive single RGB panel ultra-high resolution microLED AR display. This new process paves the way to commercial, high-performance microLED displays, bringing mass adoption of microLEDs in displays ever closer to reality.

Our achievement demonstrates once more the ability of the engineering team at Plessey to lead in the microLED technology space and deliver truly innovative solutions to well-known problems"

MicroLED technology is continuing to emerge as the most likely successor to today's smart high-performance display applications, making displays with smaller form factor, even brighter and more power efficient than current display technologies available.

Other recent ground-breaking milestones from Plessey includes the world's first wafer level bonded monolithic 3000 ppi GaN-on-silicon microLED emissive display hybridized to an active matrix CMOS backplane, and a high efficiency Native Green technology. Plessey are continuing to rapidly develop microLED display solutions with their roadmap including the production of full RGB microLED displays by 2020. ■

## Fraunhofer - Modular OLED Light Strips

At the International Symposium on Automotive Lighting 2019 (ISAL) in Darmstadt from September 23 to 25, 2019, the Fraunhofer Institute for Organic Electronics, Electron Beam and Plasma Technology FEP, a provider of research and development services in the field of organic electronics, will present OLED light strips of any length with additional functionalities for the first time at booth no. 37.

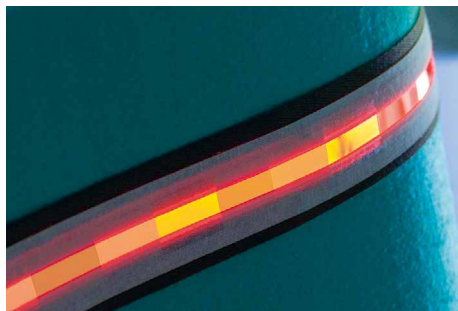

**Luminous-strips are used in many different applications: in cars, on textiles or in buildings. Especially in innovative automotive design, customized strips with additional functionalities are playing an increasingly important role**

Almost everyone is familiar with light strips for interior design. LED strips are available by the meter in DIY stores around the corner and are just as often found as under-cabinet luminaires or in decorative articles. But also in the automotive industry the demand for light strips is enormous. Customized strips with additional functionalities play an increasingly important role, especially in the area of innovative car designs.

Scientists at the Fraunhofer FEP have now succeeded in producing light strips from individual organic light-emitting diodes (OLEDs). What is special about this innovation is that the OLED light strips act like a single luminous surface without interruption.

Claudia Keibler-Willner, head of the "Sheet-to-sheet OLED Technologies" department at Fraunhofer FEP, explains this effect in more detail: "We manufacture flexible OLEDs with appropriate control electronics in such a way that any number of OLED modules can be connected without creating visible interruptions to the active surface. This makes it possible to produce infinitely long OLED light strips. An additional highlight is the individual control of the segments. This allows additional lighting effects such as different dimming or dynamic warnings to be realized."

### Why actually use OLEDs for car interiors or luminous clothing instead of using existing LED technology?

The enormous advantage of OLEDs lies in their properties as area light sources. In contrast to LEDs as point light sources, OLEDs illuminate surfaces and are therefore homogeneous. As a result, OLED strips require no reflectors, light guides or additional optics. They also impress with their extremely low installation depth and light weight. This filigree quality of flexible OLEDs, which are manufactured on plastic substrates, for example, can hardly be achieved with conventional LED technology. In addition, the reduction of glare effects contributes to increased road safety, for example in safety clothing with lighting.

The OLED can make particularly good use of these advantages in the developed modular light strips of any length: OLED strips can be flexibly applied to curved surfaces such as car bodies or furniture. They can be transparent when switched off so that the underlying surface remains visible. Thus the OLEDs almost melt into their surroundings. Dynamic control or dimming opens up additional possibilities, such as for welcoming scenarios at the car. Designer dreams for interior design are thus within reach.

The scientists are now looking forward to concrete industry inquiries to develop prototypes or small series of these light strips for innovative designs and applications. ■

### About Fraunhofer Institute for Organic Electronics (Fraunhofer FEP):

The Fraunhofer Institute for Organic Electronics, Electron Beam and Plasma Technology FEP is located in Dresden and focuses on developing innovative solutions, technologies and processes for surface modification and organic electronics.

## New CIE Technical Report: Optical Measurement of LED Modules and Light Engines

LED modules and light engines represent a wide range of very different products with unique physical properties. Thus, they can neither be treated as single LED packages (where measurements refer to a specific junction temperature of a single LED or the average of a single die, multiple-junction LED) nor as complete lamps or luminaires (where measurements refer to the ambient temperature).

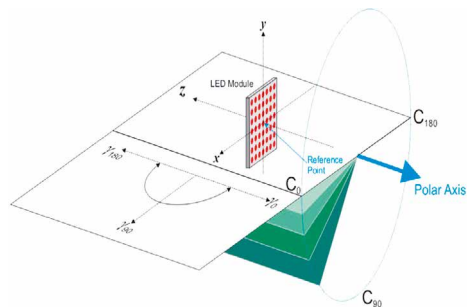

**Applying the correct methods for the measurement of photometric, radiometric, and colorimetric quantities of LED modules is essential for developing and providing high quality lighting products**

This Technical Report describes the methods for the measurement of photometric, radiometric, and colorimetric quantities of LED modules (with or without integrated control gear) and light engines that are connected to DC or AC power supplies. The report specifies the test-point temperature as a temperature reference when taking measurements.

The publication is written in English, with a short summary in French and German. It consists of 38 pages with 17 figures and one table and is readily available from the CIE Webshop or from the National Committees of the CIE.

The price of this publication is EUR 120,- (Members of a National Committee of the CIE receive a 66,7 % discount on this price - please approach your NC for information on accessing this discount). ■

### About the CIE:

The International Commission on Illumination - also known as the CIE from its French title, the Commission Internationale de l'Eclairage - is devoted to worldwide cooperation and the exchange of information on all matters relating to the science and art of light and lighting, color and vision, photobiology and image technology.

With strong technical, scientific and cultural foundations, the CIE is an independent, non-profit organization that serves member countries on a voluntary basis. Since its inception in 1913, has been accepted as representing the best authority on the subject and as such is recognized by ISO as an international standardization body. As such the CIE is recognized by ISO as an international standardization body, publishing global standards on the fundamentals of light and lighting.

## CIE: The Root to International Standards for Horticultural Lighting

Plants have evolved to make the most of the conditions in which they naturally grow. For some plants, this environment will be fully supportive; it may be less so for others. In general, the plant with the fully supportive conditions will predominate in the absence of external intervention. Humans have changed plants over the centuries, selectively growing the plants that provide maximum perceived benefits in terms of color, smell, yield and, perhaps more recently, nutritional value. For most of our evolution, we have had to make use of the environmental conditions available. The desire for cheap food, all year around, and attempts to minimize "food miles" has increased the move towards providing totally constructed growing environments.

Division 6 of the International Commission on Illumination (CIE) is responsible for photo-biology and photo-chemistry. Most of the Division's work has concentrated on the effects of optical radiation (this being

radiation from the ultraviolet through to the infrared) on people. However, the CIE has been encouraging international work on the impact of optical radiation on plants and specifically for horticulture since at least the 1980s. CIE Technical Committee (TC) 6-42 covered "Lighting Aspects for Plant Growth in Controlled Environments" and TC 6-61 "Measurement of Radiation Using the Phytometric System for Plant Applications". Considerable development work was carried out by these TCs, but the decision was taken to defer their activities in 2015, pending discussions with other organizations.

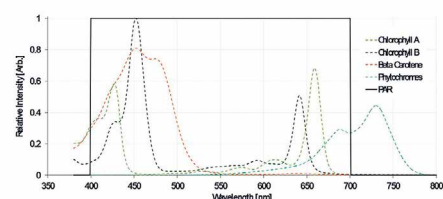

**It is crucial to know how to use the action spectra of photosynthetic active pigments instead of the  $V(\lambda)$  spectral luminous efficiency function**

The CIE International Lighting Vocabulary [1] already includes terms for some aspects of horticultural lighting and these are used by a number of national voluntary standards, such as those published by the American Society of Agricultural and Biological Engineers (ASABE) [2].

A lot of effort has been put into understanding the complexities of growing plants under electric lighting. Kniep and Minder [3] are generally credited with the first attempts at defining an action spectrum for the absorbance and quantum yield for plants. Hoover [4] and then McCree [5] built on this early work. From a scientific perspective, this certainly seems to be an ideal starting point, particularly as one of the fundamental laws of photo-chemistry is that a photon of optical radiation has to be absorbed before a photo-chemical reaction can occur. What McCree discovered is that the action spectrum varied between plant species, indeed also between plants grown outdoors and those grown indoors, but that there was a general envelope of response over the wavelength range 350 nm to 750 nm.

Of course, the optimum growing conditions for plants depend on many more factors than the spectral composition of the light and there may be some synergy between these other factors and specific wavelengths of



exposure. It is also likely that the response of the plant may be dependent on multiple wavelengths from different parts of the optical spectrum, either working together or against each other. Therefore, it may be important to consider the effects of not including some wavelengths, as well as ensuring that the key wavelengths are included.

The dosimetry required to assess the exposure of plants is complex in practice. The key part of the work of CIE TC 6-61 had been an attempt to address this. During stages of growth, during the season and even during the day, the spectral power distribution of optical radiation falling on a given leaf will vary. As plants grow, they will tend to influence the spectral power distribution received by neighboring plants and indeed by their own leaves. This will be true for plants growing naturally outdoors, for those growing in greenhouses under sunlight and those grown completely under electric lighting.

Clearly, plants respond differently to light than people, which means that familiar quantities such as the lumen, based on the  $V(\lambda)$  spectral luminous efficiency function, are not useful to horticulture. The American Society of Agricultural and Biological Engineers, in ANSI/ASABE S6402, has suggested that a single action spectrum is not appropriate because it is highly variable between plant species. Therefore, it recommends that photosynthetically active radiation (from 400 nm to 700 nm) should not be weighted for most horticultural quantities. This effectively means they are recommending an action spectrum with a weighting of one from 400 nm to 700 nm and zero outside those wavelengths.

In addition to growth, different wavelengths of optical radiation are responsible for particular aspects of a plant's development, including the development of any required flowers and fruit. LEDs have provided the opportunity to vary the light spectrum throughout the stages of a plant's life, taking into account the varying spectral needs, length of time of light exposure in a given day and the number of photons incident on the plant. However, the science is still maturing and there is an element of "try it and see". In time, it may be possible to standardize a series of action spectra to assist manufacturers of LED products and growers with optimizing the light exposure conditions.

The CIE is a technical, scientific and cultural non-profit organization whose first objectives is: to provide an international forum for the discussion of all matters relating to the science, technology and art in the fields of light and lighting and for the interchange of information in these fields between countries. Until recently, most of the work of the CIE has focused on lighting for people, but of late, the CIE has initiated discussions with a number of professional and trade bodies involved with horticultural lighting. An outcome of these discussions is a workshop on Horticultural Lighting, which will be held as part of the conference program of the CIE's 29<sup>th</sup> Quadrennial Session in Washington DC in June 2019. Various aspects of what is known and what is not known about providing evidence-based horticultural lighting will be discussed [6].

Another matter to consider in conjunction with horticultural lightning is the need of people who work in areas that are set up primarily for horticultural benefits and the impact of the lit environment on those people. National legislation is likely to restrict exposures to levels below exposure limit values. However, consideration also needs to be given to any impact on both the ability to undertake visual tasks and any non-visual effects of the lighting on the workers.

Starting from this basis of the CIE's scope and activities, and the CIE's standing as an international standardization body recognized by ISO, now is the time for the CIE to bring to fruition standards, reports and other publications concerned with horticultural lighting – starting with the roots (the basic science). ■

#### **Note:**

Anyone interested in supporting this work, as an organization or as an individual, can contact the CIE to show their interest by sending an email to [ciecb@cie.co.at](mailto:ciecb@cie.co.at)

#### **References:**

- [1] CIE S 017/E:2011. "International Lighting Vocabulary"
- [2] ANSI/ASABE S640 Jul2017. "Quantities and Units of Electromagnetic Radiation for Plants (Photosynthetic Organisms)"

## Zhaga-D4i Certification Signals Plug-and-Play Interoperability

The new Zhaga-D4i certification program and logo indicates plug-and-play interoperability of luminaires, sensors and communication nodes, and represents an important collaboration between two major, innovative lighting-industry organizations, Zhaga and DiiA.

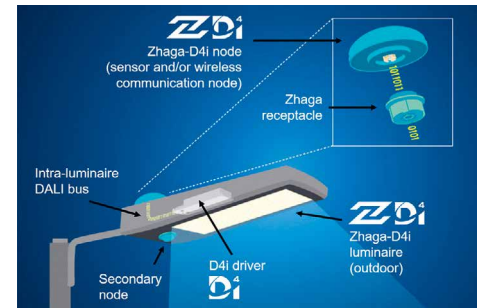

**The important collaboration between two major, innovative lighting-industry organizations, Zhaga and DiiA, led to the new Zhaga-D4i certification program**

As open, global lighting-industry associations involved in standardization, the Zhaga Consortium and the Digital Illumination Interface Alliance (DiiA) bring together several hundred, member companies from across the lighting industry. The new Zhaga-D4i certification program is the result of an ongoing cooperation and consensus between the two organizations, and combines expertise in different areas to achieve a goal that brings substantial benefits to the lighting market.

In technical terms, Zhaga and DiiA have standardized the interface between outdoor LED luminaires and sensors and/or communication nodes. The initial focus is on outdoor lighting, with indoor applications being a work in progress.

The standardization effort brings together complementary specifications from the two organizations, which cover mechanical fit, digital communication and power requirements. This ensures plug-and-play interoperability of the luminaires and nodes, backed by the Zhaga-D4i certification program.

Zhaga-D4i certification allows qualifying luminaires and nodes to carry the dual Zhaga and D4i logos, as shown in the image. This provides a clear indication of plug-and-play interoperability, which is a strong benefit for specifiers, purchasers, installers and end users.

The certification logos are trademarked to prevent misuse, and provide an established brand for product marketing. Certified luminaires and components are available from multiple suppliers, establishing an ecosystem of compatible products. Zhaga-D4i certification ensures that luminaires are future-proof, and will be able to host next-generation Zhaga-D4i nodes.

#### Market Drivers

The cooperation between Zhaga and DiiA is driven by market requirements for smart, interoperable LED luminaires with pluggable IoT connectivity.

A plug-and-play, socket-based connectivity system makes it easy to add or upgrade sensors and/or communication nodes, which in turn enables luminaires to keep pace with rapid developments in digital networking and sensing technology. By replacing the node rather than the entire luminaire, the luminaire is future-proofed. Also, where the node allows wireless communication, this facilitates the connection of the luminaire to an external lighting-control network. Other functionalities beyond lighting can also be supported.

In addition, the use of intelligent DALI-2 drivers enables luminaires to collect, store and report a wide variety of data in a standardized manner. A smart luminaire can communicate and interact with a lighting-control network, providing energy consumption data, or fault detection, or many other parameters. In turn, this can result in significant cost savings in terms of energy efficiency and maintenance.

#### Complementary Specifications

The published Zhaga Book 18 Edition 1.0 specification defines the mechanical fit and electrical pins for a connectivity system for outdoor LED luminaires. An extensive overview of this specification was presented in a previous article [1]. The Zhaga connector allows sensors and/or communication nodes with a standardized Zhaga Book 18 plug to be easily connected to the corresponding receptacle (socket) in the luminaire.

The Zhaga connector makes it easy to add or change sensors and/or communication nodes, and to upgrade the luminaire during its lifecycle. However, for full plug-and-play interoperability, as well as enabling luminaire features such as intelligent interaction with external networks, the connectivity system

also needs to take care of power and lighting-control requirements.

A solution is provided by the D4i specifications for intra-luminaire DALI, which have been published by DiiA. D4i represents a specific set of features associated with DALI-2 certification. The upcoming Edition 2.0 of Zhaga Book 18 references these D4i specifications. As the name suggests, intra-luminaire DALI refers to a DALI bus within an individual luminaire. The bus connects the LED drivers inside the luminaire with any DALI control devices, for example, a sensor or an application controller. As well as providing power to the LEDs, a D4i driver has an integrated bus power supply that can drive the other DALI components.

In the Zhaga-D4i case, each receptacle on the luminaire is connected to the internal DALI bus. When a node is plugged into the receptacle, this establishes bi-directional interaction between the node and the D4i driver(s) using the well-established and standardized DALI-2 protocol.

The D4i specifications ensure that power is available to the luminaire's Zhaga receptacle. In addition to the integrated DALI bus power supply, each Zhaga-D4i certified luminaire also includes a 24V auxiliary power supply (which can be part of the driver or a separate component inside the luminaire).

#### Smart D4i Drivers

But the D4i specifications go further, by standardizing the storage and retrieval of data in the DALI memory banks of a D4i driver. The Part 251 specification describes how to store luminaire-specific information that has no impact on the functionality of the driver. For example, a manufacturer can encode data about the luminaire - such as part number, or nominal light output - in the factory. When the luminaire is installed, the data is readily available to the lighting-control network. A utility company or lighting-installation owner could use this capability to monitor and manage their lighting assets accurately and efficiently.

The Part 252 specification standardizes the storage and reporting of data relating to the driver's usage of energy and power. Meanwhile, Part 253 focuses on diagnostics and maintenance, and covers a wide variety of data related to the driver, light source and luminaire.

#### Certification Program

Later this year, Zhaga-D4i certification will be available for LED luminaires that have a powered Zhaga Book 18 receptacle and use D4i drivers inside. Likewise, it will be possible to certify Zhaga-D4i nodes i.e. sensors and/or communication devices with a Zhaga Book 18 plug and D4i compatibility.

Zhaga-D4i certification for luminaires will be granted after a Zhaga test center has confirmed compliance with the interoperability requirements of Zhaga Book 18. One of the key criteria is the availability of power to the socket. Zhaga will also check that all drivers inside the luminaire are already Dxx-certified. A certified Zhaga-D4i luminaire will be eligible to carry the dual Zhaga and D4i logos, and will be listed in the public database on the Zhaga website.

For a Zhaga-D4i node, the first step is for the manufacturer to achieve D4i certification as part of the DALI-2 certification program operated by DiiA. DALI-2 certification requires the manufacturer to submit test results to the DiiA website; certification is granted after the test results are verified. If a DALI-2 control device or driver has successfully implemented all the features required by D4i, then the D4i logo will be permitted on the product. All D4i certified products will be listed in the DiiA product database. After D4i certification, a node with a Zhaga plug can be submitted to a Zhaga test center, where Zhaga-D4i certification is confirmed. ■

#### References:

- [1] Zhaga Enables Mechanical IoT- Upgradability for Outdoor LED Lighting Fixtures", in LED professional Review issue 69, Sept/Oct 2018, p42

# Optisolis™

## A masterpiece of LED lighting

Delivering LEDs that mimic natural sunlight,

Optisolis™ is the best choice to illuminate

the most beautiful objects.

### Optisolis™ features:

- Full spectrum light
- Highest colour rendering
- No damaging UV
- Proven long lifetime and performance
- Unmatched NICHIA quality and reliability
- NICHIA's proprietary technology
- Available in SMD 3030 packages (757Series) and various Chip on Board models

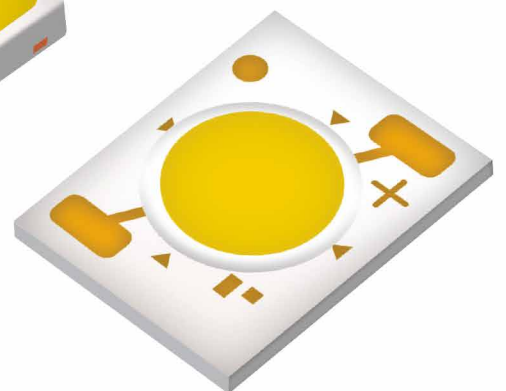

Create the best possible light solution for your museum, art gallery, hospitality or retail customers. Get a sample of Optisolis™ by emailing us today: [info\\_de@nichia.eu](mailto:info_de@nichia.eu)



Learn more, visit [NICHIA.com](http://NICHIA.com)

## TECHNICAL REGULATORY COMPLIANCE UPDATE



Segment	Product	Standard (Certification)	Region	Technical Regulatory Compliance Information
Energy Efficiency	Luminaires	Order No. 10305002151	Taiwan	<p>Energy Conservation Labeling Program Requirements for Luminaires, Order No. 10305002151, 2014 - Amendment - (on testing, applicable standards, etc.) Order No.10805010700, 2019.</p> <p>Taiwanese Bureau of Energy on 23 August 2019 published order No. 10305002151 with the Amendment Order No. 10805010700, modifying the Energy Conservation Labeling Program Requirements for Luminaires.</p> <p>The main changes are the ceiling/wall reflection coefficients to 0.5; testing conditions and methods for light distribution and colour temperature.</p> <p>The following Taiwanese national standards have to be respected in addition:</p> <ul style="list-style-type: none"> <li>• CNS 16027 G5/G13 on Double-capped LED lamps – Performance requirements</li> <li>• CNS 15630 on Self-ballasted LED lamps for general lighting services with supply voltages &gt; 50 V - Performance requirements</li> <li>• CIE TN 006:2016 on Visual Aspects of Time-Modulated Lighting Systems (led flicker testing)</li> <li>• CNS 62931 GX16t-5 on Capped Tubular LED lamp – Safety specifications</li> <li>• CNS 15592 on Photobiological safety of lamps and lamp systems</li> <li>• CNS 15983 G5/G13 on Double-capped integrated LED lamps - Safety specifications</li> </ul> <p>The amendment also demands to indicate several technical parameters in the product catalogue: the rated power, total luminous flux, colour rendering index, colour temperature, luminous efficiency, power factor index, photobiological safety, flicker index, and percentage of flicker of the product.</p> <p>The order will come into force on 1 September 2020.</p>
Energy Efficiency	Different Lighting and Non-Lighting Products	Guidance Documents	New Zealand	<p>The New Zealand Energy Efficiency and Conservation Authority published a number of information sheets and guidance documents.</p> <p>These information sheets cover various requirements for minimum energy performance standards (MEPS) or mandatory energy performance labelling (MEPL)/energy rating labelling (ERL) for different lighting and non lighting products. These documents provide a useful checklist for importers or manufactures of such kind of products in New Zealand.</p> <p>It was published on 17 September 2019, covering: clothes dryers, clothes washer, compact fluorescent lamps, televisions, computers and laptops, computer monitors, dishwashers, air conditioners, refrigerated cabinets, refrigerated display cabinets, ballasts for fluorescent lamps, fluorescent lamps, set top boxes, three-phase cage induction motors, heat pumps, chillers, household refrigeration.</p>
Energy Efficiency	Directional Lamps, LED Lamps and related Equipment	Resolution No. 264, 2019	Ukraine	<p>On 27 March 2019, the Ukrainian Cabinet of Ministers approved Resolution No. 264. This technical regulation gives eco-design requirements for LED lamps and directional lamps as well as related equipment.</p> <p>The resolution is based on the EU Regulation (EC) No 1194/2012 for requirements for directional lamps, light emitting diode LED lamps and related equipment regarding energy requirements.</p> <p>The following products (also integrated in other products) are covered:</p> <ul style="list-style-type: none"> <li>• directional radiation lamps;</li> <li>• LED lamps;</li> <li>• equipment designed for installation between the mains and the lamps, including lamp control gear, control devices and luminaires (other than ballasts and luminaires for fluorescent and high-intensity discharge lamps).</li> </ul> <p>Also requirements regarding the product information for special purpose products are set up.</p> <p>Excluded from this resolution are LED modules sold as part of luminaires with quantities less than 200 units per year.</p> <p>Verification of conformity shall be given, amongst others, through a technical documentation file:</p> <ul style="list-style-type: none"> <li>• containing a copy of the product information (in accordance with part 3 of Annex 3);</li> <li>• providing any other information required by Annexes 1, 3 and 4;</li> <li>• specifying at least one realistic combination of product settings and conditions in which the product complies with this Technical Regulation.</li> </ul> <p>The resolution came into force on 4 October 2019.</p>
Energy Efficiency	Lighting Products and Separate Control Gears	Single lighting regulation	Europe	<p>Again postponed: In early December the EU will publish the first version of the so called "single lighting regulation" acc. to latest plan which covers lightsources of all kind of technologies and separate control gears. In this regulation the energy performance criteria as well as the energy labeling of lighting products is described and will come into force in September 2021. The energy classes in this regulation will go from A to G and also test parameters regarding endurance and such are adapted to all technologies.</p>

**Disclaimer:** This information is research work of TÜV SÜD Product Service and is intended for general information purposes only. The content is publishable only after having the consent of TÜV SÜD Product Service. If it is published with any changes, the company is not liable for it. The information is subject to change and all rights for it are reserved by TÜV SÜD Product Service GmbH.

A free training can be arranged for a clear understanding of the upper stated standards.

For further information on the latest upgrades and testing standards and training, please contact [cps@tuv-sud.com](mailto:cps@tuv-sud.com)



# The Comprehensive Guide to the Lighting World

**REGISTER FOR FREE**

[www.GLD.lighting](http://www.GLD.lighting)

# Tech-Talks BREGENZ - Prof. Ruairí O'Brien, Founder of Ruairí O'Brien Lighting Design



## Ruairí O'Brien,

Ruairí O'Brien is currently an associate professor and head of the Architecture and Visual design department at the German University in Cairo.

He has executed a diverse portfolio of work including urban design, innovative and custom-built street lighting, public and private buildings, museums, memorials and exhibitions, just to name a few. He has also worked on theatre and dance projects, created sculptures, installations and performances with light. In 2003, he initiated the Light Poetry Festival LIGHT and WORD.

In 2014, he was co-founded of the Federation of International Lighting Designers and served on the board as Vice President until 2018.

O'Brien's international teaching experience includes contracts for universities in Germany, Czech Republic, Russia and Syria. As a visiting professor at the University of Wismar (2001–2005), he helped initiate the international master's course in Architectural Lighting Design.

O'Brien studied architecture at the University of Greenwich and at the University of Edinburgh, where he received a "Visiting Scholarship" to Columbia University.

O'Brien's research interests are an extension of the topics he has developed as an interdisciplinary practicing architect and lighting designer.

Ruairí O'Brien, associate professor and head of the Architecture and Visual design department at the German University in Cairo and CEO of Ruairí O'Brien. Architektur. Licht Raumkunst, surprised and delighted the audience with his lecture at LpS 2016 when he talked about allowing darkness. He expressed the same sentiments in a caption for a figure in the proceedings booklet: "The future in Dresden is not lighting excess - the future is Re-Darkness with intelligent SSL concepts." This year, Ruairí held two lectures at TiL in which he emphasized how important a thorough application of light is in respect to culture, ethics, and environment. In addition to his work, these interesting statements made it made a Tech-Talk Bregenz with him a top priority.

**Ruairí O'Brien:** I am from Ireland, born in Dublin. I moved to London to study architecture after finishing school and did my postgraduate studies in Edinburgh during which I also received a "Visiting Scholarship" to Columbia University in New York. After New York I returned to London to work as an architect and to do my professional practice qualification. It was at this time that the Berlin wall came down and the drama of Europe expanding eastwards inspired me to move to Germany. I got my first job in Frankfurt am Main but I soon found that the real "Zeitgeist" could be better experienced in cities like Dresden and Leipzig. In Dresden I was fascinated by what I saw, a dark stoned city and the still visible scars of World War II mirrored in its beautiful river, the Elbe. The open discussions about what it means to rebuild a city and of course the "Frauenkirche" debates were thought provoking and extremely stimulating. It was an extraordinary place to be at that point in time.

**LED professional:** Were you working as an architect or as a lighting designer at that time?

**Ruairí O'Brien:** At the time I was working as an architect. But as an architect I was always concerned about how light triggers a space into life. This interest in how light creates and defines space began very early, as a teenager I visited the national gallery in Dublin numerous times enjoying the light in the paintings and in the spaces of the galleries, the spaces within the spaces so to speak. It was during these visits to the masters of light, the painters, that I first thought that realms of light, painting and architecture could be perceived as being one and that somewhere in this triangle I could find my future. Because of my background and my interests in light I was always trying to find ways to work with light as a student at university and as an architect. Later as a member of staff in a big office I realized that it is not always easy to follow your personal interests and there comes a point when you

either accept this or you move on, so in 1995 I opened up my own practice.

**LED professional:** What were your first projects?

**Ruairí O'Brien:** A good example of one of my earlier projects was a project for theater which I called Interactive 3 and 4. My intention with this project was to demonstrate to lay people and theater guests how important light and architecture is to our everyday existence. I wrote a short script and found some dancers who would work with me and a theater house in Dresden that was interested in showing it. It was very successful. You could say it was a kind of Human Centric Light project for theater. For the project I built a series of mobile boxes with wood and plexi glass and executed a series of drawings depicting how the dancers should move in and out of the boxes according to their circadian rhythm experienced over a 24-hour cycle of day



As far back as 1995, Ruairí O'Brien addressed the question of how much light humans require in the My Light Theater Project with Interactive Rooms 3&4



Ruairí O'Brien when asked why he chose the topic "Inside the Pyramids – Light Where There Should Be Darkness" for one of his lectures at the LpS/TiL 2019

and night. Dynamic light positioned above the boxes animated and directed the movements of the dancers. The theater guests experienced the dancers being born or awoken by the bright morning light in their boxes, this was followed by diverse morning activities and continued on with the dancers performing working rituals in glaring office light and ending with a performance about leisure and interaction with the theater guests in a warm dusk light that phased into the darkness of nightlife, sleep and the chaos of the world offered by dreams.

**LED professional:** In one of your earlier articles in the LpR you also sent us some pictures from those days.

**Ruairí O'Brien:** Yes, that is right, I mention it again because with the passing of time this little project becomes more and more interesting in my eyes and in its importance. It really says everything and provides me with the core themes that we as lighting designers should be talking about in the public and

political forum. Take the lecture I gave today, "Inside the pyramids - light where there should be darkness"

Not only did the Sun God Ra and Kek the God of darkness and Chaos get a mention but the main question I asked was how much light do we need to see in the dark. There is a physiological answer to this and a philosophical answer to this question.

How much light do humans require to live, to work, to love and to play, how much space and how much resources do we need? All these big questions were in this little simple project. Today I am happy to make this project very important. I remember when I opened my office and people asked, "What have you done, show me your references". Well I did this theater project but of course a lot of clients could not always see the direct link to their world and their needs and their projects. However, this experience at the beginning taught me to try and find clients that had similar interests and, if necessary, to create and initiate my own projects.

**LED professional:** But this theatre piece wasn't the only artistic work you did. You also do light sculptures and you initiated a light poetry festival. Do you think of yourself as an artist that works with lighting or a lighting designer that works with art?

**Ruairí O'Brien:** I think this the most difficult challenge I face as a freelancer to communicate successfully that there is a need for designers that do not pay attention to artificial professional barriers. I consider myself to be a polymath, I do not see boundaries I see opportunities, areas and things that awake my curiosity, my interest and my ambition. If I were a client I would be the kind of architect or lighting designer that I would like to employ, one who would challenge me in my own interests and in the interests of the project I wanted to execute. Unfortunately, I meet a lot of people and clients that think in order to do a project – in the symbolism of the theater project mentioned above – that you need to stay in the box of a specialist area. I see myself being capable of





A water color sketch by Ruairí O'Brien demonstrating where in the original concept of the pyramids, darkness should be, where today there is light

The Grand Gallery – BEFORE...No concept

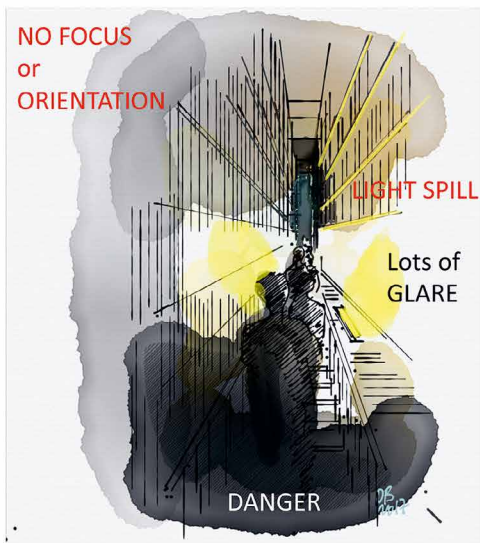

**BAD...** Lots of accidental Light...

The Grand Gallery – AFTER...with concept



**BETTER...** NO Accidental Light...

**Remember:**  
"LIGHT enables us to read the city and its architecture..."

Legibility is communication

The importance of "Offerings" and "Secrets" ...

Ruairí O'Brien Lighting Design FILD, LITG

Comparison of the current situation with a possible new lighting concept that accommodates safety and expectations of the visitors while respecting the intended privacy of the pyramid as good as possible



While some think of poetry and festivals as weak vehicles for transporting the message about the meaning of light, Ruairí O'Brien doesn't agree. He feels they are one of the most potent vehicles of change. Impressions from the Light Poetry Festival in Dresden, 2003



The "Micro" Light sculpture as homage to Inger Christensen is another example how to generate awareness for the importance of light in our life

existing inside and outside the box of specialization. A problem I observe in society is that there is a tendency to think that only a specialist can give us the right answer to a problem, which is of course also a marketing strategy for some and also a way of avoiding responsibility perhaps, but often the specialist cannot see the extent of the bigger picture. So, in the end we have a lot of fragments that do not work together in a holistic manner. People get nervous when polymaths or designers like me who have also worked as a specialist in many areas, talk about complex technology using the terminology of a generalist. If we want the importance of good lighting design to be understood in society we need to make our thoughts understandable. We cannot allow specialists to cloud or fragment the messages we want to send out to the public. The field of lighting design is very young and still developing, we need the big thinkers, the

polymaths, the interdisciplinary generalists, we need the boundaries to be more open. That is why I challenge my own working process and development with the art projects I do where I bring science and art together. The lighting sculptures I developed enable me to experiment with technology and the human interaction with light free of the constraints normally associated with an architectural or city planning project. This is also applied research and often as in the lighting masts for the market square in Freiberg, Germany, this applied research tested in my sculptures and installations finds a new form of expression in a more traditional urban or architectural project.

The Light Poetry Festival I started in Dresden in 2003 was about presenting light to the public as a medium for precise, simple and complex communication, poetry may seem weak to many,

but it is one of the most potent "Vehicles of change" known to mankind. In this sense I want to communicate that light is a life changing and life-giving force.

**LED professional:** Looking at lighting design in general, we have seen a lot of changes taking place over the past few years. When I started working with light in the late 1980's, light was very technical. You needed your 500 Lux and a strict cut-off angle, and so on, but since then we have moved on to dynamic lighting and LED colors in lighting. We now have variable color temperatures, and human centric lighting, and so on. How do you see these developments? Have they really improved lighting or is it just popular because it's new?

**Ruairí O'Brien:** It is fantastic to witness the technological developments that are taking place and it is true that we now have far

more sophisticated tools to avail of. But we should remember that good lighting is in the first instance about doing the simple things right, not correcting design mistakes with highly sophisticated and expensive technology. We have to approach each new task as a lighting designer with a holistic mindset. For example, the lighting designer is required today to interact with the architect on the planning of the daylight, the choice of materials and furniture, he or she must have a comprehensive understanding of architecture and building construction to be truly helpful in creating the right light for the spaces being designed. It is not enough anymore to know when executing a design for an office or workspace that a general lighting quantity of 500 lux is required or that task lighting requires 700 lux; one has to know far more about how society is changing and how people use space. Today the office worker doesn't constantly sit at the desk like he or she used to. Today's workspaces need to offer zones with different ambiances and atmospheres to accommodate the greater freedom of movement that people desire. People want to work individually or in clusters depending on the tasks and on their own moods, desires and needs. It is obvious that a purely technical approach, selecting the "right" Lux quantity will not suffice for such complex scenarios. In a more sophisticated society quantity is never going to win against quality. Of course, health and safety regulations need to be observed but that's the easy part, keeping an eye on the bigger picture of "happiness" at work, that is the difficult part, that will be the biggest challenge facing the lighting designer in the future, being strong and educated enough to take this responsibility. Turner, when he first started to paint, was very exact, technically as good as anyone before him, but his great works, that fascinate us today, seem blurry and, at the time, his peers thought he had lost control. Today we know he was just ahead of his time and that he had complete control of this blurriness and produced some of the most beautiful paintings on light mankind has seen. This is what I think makes a great lighting designer; having so much control that it is hard to see what you did.

**"Eating the Light" - light sculptures to revitalize the Lingner Castle in Dresden: Experimenting and applied research opportunities for people of any age lead to understanding**

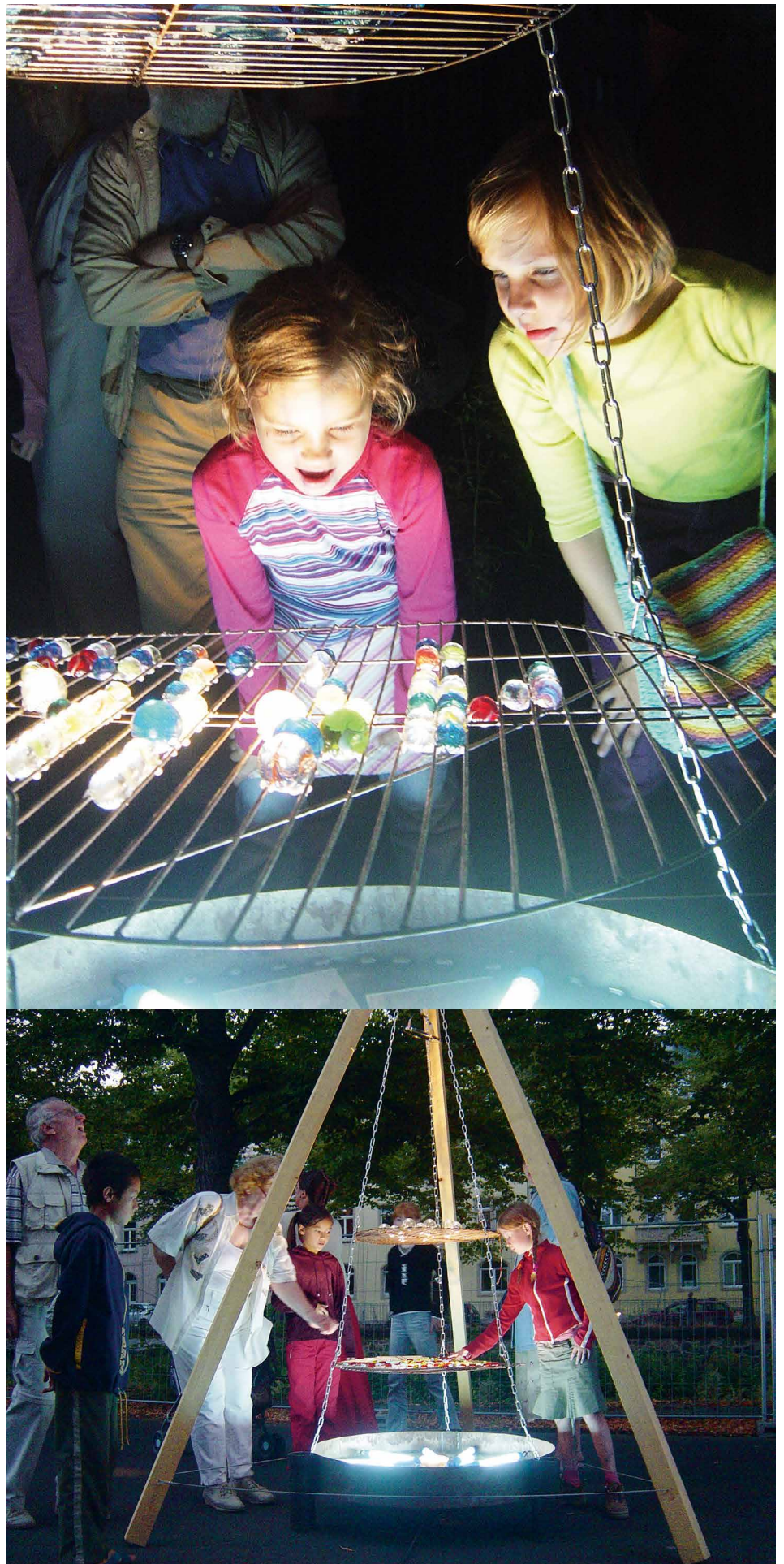

**LED professional:** You mentioned Human Centric Lighting before. Some people say that all lighting should be human centric. What do you think? Is it just a catch phrase or is it something that is achievable now with the tools and technology available today? Has the opinion of human centric lighting changed due to the research results over the past twenty years?

**Ruairi O'Brien:** When I was teaching at the university in Wismar I communicated to the students from day one a user orientated holistic approach to lighting design where the well-being of humankind was placed at the center of the design. If you like, it was human centric lighting design. The terminology Human Centric Light (HCL) as it is now being used in the industry is based on the use of technological tools and luminaires that enable the designer and, in turn, the client to tune the color temperature and the intensity of the light to follow the circadian rhythm of the user. However, I think many lighting designers are concerned that a label or a catch phrase such as HCL can also be misused to sell expensive products that cannot deliver what is being promised or being recommended for installation in areas and projects where it is not appropriate or necessary.

I do not think that the research work being done on the topic has delivered all it can as yet, it is still only the tip of the iceberg we are

seeing, but at least we know the ice berg is there. On the other hand, it is good to have a catch phrase, if it is being used with responsibility, that focus's the attention on the importance of good lighting in the context of human wellbeing. In this sense I believe the term Human Centric lighting should always be understood to include the interaction of artificial lighting with that of the daylight planning of a building. I always enjoy, when talking about HCL with my students, revealing the fact with the support of various diagrams that one of the reasons why they are so tired during the first morning lectures is because of the level of melatonin still flowing through their bodies and that they should also avoid the blue light of their telephones and laptops before going to bed at night, hopelessly of course...

**LED professional:** There is a debate about whether we should bring the subject of melatonin into human centric lighting – or whether human centric lighting is just about creating a good mood or visual comfort, because subjects like melatonin go far beyond visible light. Do you think things like UV, infrared, melatonin, etc. should be under the heading of human centric lighting?

**Ruairi O'Brien:** The truth is, it is very difficult to exclude the discussion about melatonin, UV or infrared if I open the Pandora's box with the claim that HCL can improve

human performance in working spaces by increasing the level of concentration at certain times of day and provides workers with a healthier light. If I want to sell these products I have to provide evidence that they do work as described above without any negative side effects. Of course, the terminology HCL can help in the communication to clients and the general public that we should expect more from the artificial lighting being installed in our workplaces and that it is advisable to give this more thought and invest more money in good lighting. But HCL is not a concept that "fixes all" problems caused by the bad planning of workspaces with regards to inadequate daylighting. The application of HCL in schools and hospitals brings a greater responsibility with it and needs ongoing monitoring and further research. Therefore, I think perhaps we should qualify it a bit further with the differentiation in the description of a soft HCL that may support moods, atmosphere and visual comfort or a Hard HCL that would imply biological stimulation and manipulation. I believe the jury is still out on this one.

**LED professional:** Doesn't it make the topic even more complex than it already is? How do we explain to a client that the UV light doesn't always make sense for producing vitamin D because the people sitting in that area are fully clothed?



"Darkness is the true partner of light."  
For public spaces like the Freiberg market square it is important that the city silhouette can be seen against the evening sky and that light is not excessive as the market square is the dining and living room of a city

**Ruairi O'Brien:** This is a question of professional ethics and credibility. The lighting designer needs to be prepared to answer questions about products from a neutral and objective position. We've noticed with some car manufacturers that promises were made that could not be kept. The lighting industry has to be careful that they don't promise something that they cannot deliver. That's why it's always good to have objective people in the loop who can give independent advice such as the lighting designer. I think the profession of the lighting designer has to be very clear about the importance of their objective expertise for the sake of society and the industry as a whole. That is why I also helped found the Federation of International Lighting Designers (FILD) so that Lighting designers could share knowledge and experience with each other and voice their concerns and interests in a collective voice to the outside world. We shouldn't be afraid to put up our hand and say that we don't understand something – I think we also have to be able to say, keep it simple, I tank my own vitamin D by going for a long walk outside. Where there is a medical issue then we need to get appropriate professional support involved. I have learned that our profession, and myself, personally, have been too diplomatic in the past and possibly too polite. Other people are not so polite, and have other interests which do not always lead to good lighting. We should definitely be more vocal about what we think is good lighting and which technology is appropriate for which use. For years I have been including a slide with a photo of fast food and a photo of healthy food in my public lectures to help people reflect on the difference between bad and good lighting, I used to apologize for the ugly greasy fast food image now I don't do this anymore I just say that's how it is, take it or leave it...nobody in the industry can say any more we don't know what the true price of bad lighting is.

**LED professional:** If you don't mind, I'd like to talk a little about IoT, now. IoT has become something that not only is used in lighting but in all aspects of living. What does that mean to you, as a lighting designer and what effects could it have on the future of this profession?

**Ruairi O'Brien:** For the lighting designer the question is how much responsibility do we share with other technical experts without losing the control or sight of the "Raison

D'etre" which is good lighting. If I have IT experts in the lighting industry who have not been schooled to understand that the core issue is the quality of the lighting then in the middle to long term IoT will do damage to the culture of good lighting. Here the emphasis must be on Light Centric Concepts and Teamwork. It is in the lighting industries own interest to protect the lighting designer in his position as head of the team over all other interests, this enables an objective quality control to take place. Of course, Lighting designers have to do Continuous Professional Development (CPD) to stay top of their game and this includes understanding what change and digitalization means for us and the user. IT experts and Lighting designers need to be very patient with each other in exchanging views on what is important for the industry. Nevertheless, let me say that the IoT alone cannot give me the romance of a candle lit dinner. Let's not forget the candle and the romance.

**LED professional:** You said that the industry has to do something to protect you so that you can do your job right. My personal feeling is that things are going in the opposite direction with all of this IoT stuff that the lighting industry wants to put into their products. If an IoT expert says that they want a luminaire in a certain place for various reasons, you have to place it there. Isn't that more confrontational than connecting?

**Ruairi O'Brien:** Yes, you are right, in such cases we have to be louder and communicate to the client and the general public how important it is to have a true choice. Comfort food is not always what we need even when we want it, it is important to make people aware of the alternatives. Perhaps the market will demand alternatives if it is made aware of the problems that experts like lighting designers see associated with a total IoT. The philosophy behind the IoT is that we should have more freedom not less, digitalization should be able to offer us more diversity, not less, but this is not always the case. With 3D printers' people will be able to print their own luminaire designs, that may start to happen on a bigger scale, so is the lighting industry creating more of a problem for themselves by making their products too sophisticated and too expensive with all the IoT stuff as you say? I think that they should concentrate on making luminaires that produce good light and do not also have to turn the coffee machine on or tell someone how long I

spend in the bathroom. But I think we will be moving in a direction where we will need a protective bubble – where there is none of this. As a client, or as a human being, I will want my bubbles where I am not affected by any of this. I don't know if that's too visionary but I like to have zones where I am completely out of it and I don't like it, even now, when I move and my telephone tells everyone where I am. I think there is going to be a freedom movement. It's like in the old Western where you have to put your guns up on the bar – in future you'll have to put your phones up on the bar and talk to real people.

**LED professional:** I had intended to ask you "How connected must light really be?" but I'm not sure if I still need to!

**Ruairi O'Brien:** Look, we have family and loved ones but we also have ourselves; and although there is a connectedness there is also the un-connectedness in every relationship no matter how intimate and I feel that we need to fight for this space in a society that wants to connect us all the time. Every artist knows this and it is the same for a community or a society. So maybe we need to have a more artist-driven society.

I do not want the lighting in my apartment to greet me with what collected data considers to be the appropriate mood lighting for my evening ahead or the colors of the national football team because we have reached the semi-final of the world cup. Technology that saves energy is fine if it really does this but I do not want life to be so predictable, so perfect, so programable and so fake. There's a line that I use sometimes: There is no such thing as splash-free spaghetti. It's my life philosophy. If you like eating spaghetti just don't wear a white shirt if you are worried about getting specks of red sauce on it. Total Connectedness is about as much fun as splash free spaghetti. Enjoy unpredictability.

**LED professional:** To follow up on that – what do you think about the dynamizing and personalization trends?

**Ruairi O'Brien:** We know that artificial light has always modeled itself on natural light, in the basic form of trying to eradicate darkness at night by making night to day, or in a more sophisticated form of mimicking the spectral richness of daylight in products. Natural light is by nature dynamic and with

the technological possibilities available to us today this means that we can now mimic this dynamism. Is this a good thing? Yes, if you want people to be less bored in boring spaces, but in truth if the architecture in its spatial richness, views offered, materials chosen, daylight planning are all of a high quality then the light needed to bring the required lighting scenarios to life does not need to be dynamic, it just needs to be good.

Let the life of the space itself be dynamic where possible. Regarding personalization trends, yes, it is good to give individuals and users in general more possibilities to fine tune the light of their personal zone in an office or in the home. However often the choice available is far bigger than the basic needs that most people have, if this is correctly communicated to the client then this is perfectly alright but again it does not necessarily lead to good and appropriate lighting.

**LED professional:** I'd like to get back to your ideas, and not lighting design in general. Most people who are in the lighting design industry say that we need light. You, however, say, we need darkness – and then we need light. Could you explain to our readers why darkness is so important to you?

Ruairi O'Brien: When painting a watercolor, I have to be very careful

how I proceed, it's all about layers. As soon as you have too much of anything it is difficult to go back, working with light is similar one can compare the fragility and sensitivity of the white watercolor paper with the fragility and sensitivity of the darkness of the night sky. We have too much light in our cities and the installation of artificial light is developing exponentially in one direction, making night to day. LEDs should have helped in reducing energy consumption, but because LED's are cheap and smaller than the light fixtures of the past, more and more light has appeared in our cities. It has spiraled out of control as brightness brings more brightness and buildings and cities enter into a competition of wanting to be seen brighter as the neighbor. Darkness is the true partner of light. I need very little light to put anything in focus if I have enough darkness. I will need less energy, less costs this is more effective and sustainable. My message is – if we start with more darkness we need less light to create visual comfort and to create atmosphere and quality. I know that there are many people in the industry that do not like to hear this but there are also a lot of people coming around to seeing it this way. In my lecture about the future of city lighting I showed a slide of Dubrovnik as an example of many cities I have visited where the streets at night are so bright it hurts the eyes

and the buildings look dead and uninteresting, as they are illuminated by what I call "Botox lighting", producing a mono tonal sameness that lacks all architectural charm and intelligence. In fact, today we now have smaller and more precise lighting tools we can truly do more with less. This should be our motto for good lighting, doing more with less.

**LED professional:** You have lived in different countries and different cultures. How does lighting design reflect cultures?

Ruairi O'Brien: I believe there is an intercultural understanding of light that can transcend all perceived barriers. In the Master's Program in Wismar we had students from all over the world and from different cultures wanting to be lighting designers and I used to start the first lecture with: Light is its own language. It doesn't matter where you are from or what your cultural background is – people have a complex physiological, philosophical and poetical relationship to light. So, we can communicate with people, just by using light. That was the core idea behind the Light Poetry Festival I set up in Dresden, light is a code that can trigger intuitively strong emotions, tell stories, calm and excite. In Cairo where I am teaching at the moment there are wonderful pockets of darkness where the cafes light the streets.

"Haribo Lighting" and "Botox Lighting" are two terms that Ruairí O'Brien uses to characterize overly colorful and unaccentuated lighting that ends up being too bright



**Haribo Lighting**  
A one song wonder

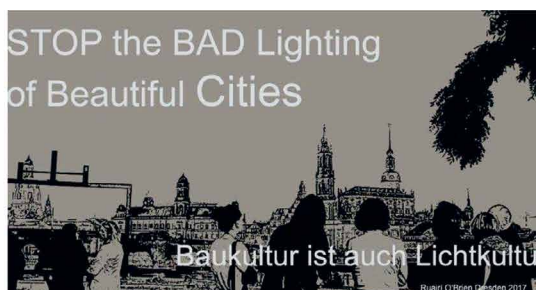

Lets talk about **GOOD** Lighting...



**Botox Lighting**  
Buildings damned to silence

**THE NEED FOR MORE CONTROL...DIVERSITY and DYNAMMIC**  
*„Kitsch is about as useful as a pair of Flipflops on the Titanic...“*

It helps me imagine how cities could be if we could develop more intelligent and diverse lighting masterplans that are truly in tune with the unique urban identity of the cities we live in and not just copy and paste culture pastiches.

**LED professional:** As we come to the end of the interview I'd like to ask you about how much energy you think we can really save with LED lighting. What is your opinion of the environmental aspect in your business?

**Ruairi O'Brien:** I think that our profession has to lead from the front on environmental issues if we want to stay relevant in the years to come.

The success of LED lighting will continue to mean that artificial lighting, as I mentioned above, will not help us collectively save energy. We will only save energy on a large scale if we, as influencers, help initiate a mindset change in clients and users about what is adequate and good lighting. We need to communicate that the quality of light is more important than the quantity of light and that includes darkness as part of the lighting design. In this respect, the lighting designer is now required to up his game and get

involved in the political discussion in policy making for better urban lighting regulations. I, for one, always include these arguments in my discussions with clients and the general public. One of my more recent projects was to develop an urban lighting concept and design guidelines manual for the city area of Lichtenrade in Berlin. This gave me the chance to speak about such important issues with local citizens, business people, city planning authority representatives and politicians over a period of several months. It was very enjoyable work as I felt that it was a great privilege to be able to contribute with my expertise to the development of a large urban community in a participatory process. I talked about the need for "Climate Change Lighting Design" and the "Right to Darkness" years ago and I noticed that I did not always make friends with such opinions, but now I feel as I did in Berlin that the people, the politicians and the local authorities are open to such thoughts. The lighting industry needs to move with the times and support this change. Presently I am working with my office in Dresden on a concept for a small lighting festival in Potsdam. Lighting festivals, generally have a lot of what I call "Haribo" lighting or mindless computer animation. I am delighted to say that that I was able

to win over the city authorities in Potsdam to try a different approach that is more in tune with the architecture and the character of the city where the emphasis is on reduction and communication. This shows that lighting festivals can also be responsible. These are all little things and they may seem like a drop in the ocean to some, but I am experiencing a trend where political and public offices are becoming more aware of their responsibilities and citizens more aware of their interests.

**LED professional:** So what would your final words to our readers be?

**Ruairi O'Brien:** Courage to say NO to Haribo and Botox lighting concepts and YES to Climate Change Lighting Design. Give Darkness a chance in the interests of good lighting.

Learn to do more with less and there is no such thing as splash free spaghetti.

**LED professional:** Thank you very much for your time!

**Ruairi O'Brien:** Thank you for having me! ■

Inspired by a 19<sup>th</sup> century painting of the Hofkirche in Dresden in evening light, at the LpS 2016, Ruairí already illustrated different "trending" lighting scenarios (here multi-colored and cool white) and demonstrated that these solutions are not appropriate for historical buildings: His vision is to bring darkness back to the city allowing old facades to appear as they did in mediaeval or pre-industrial times

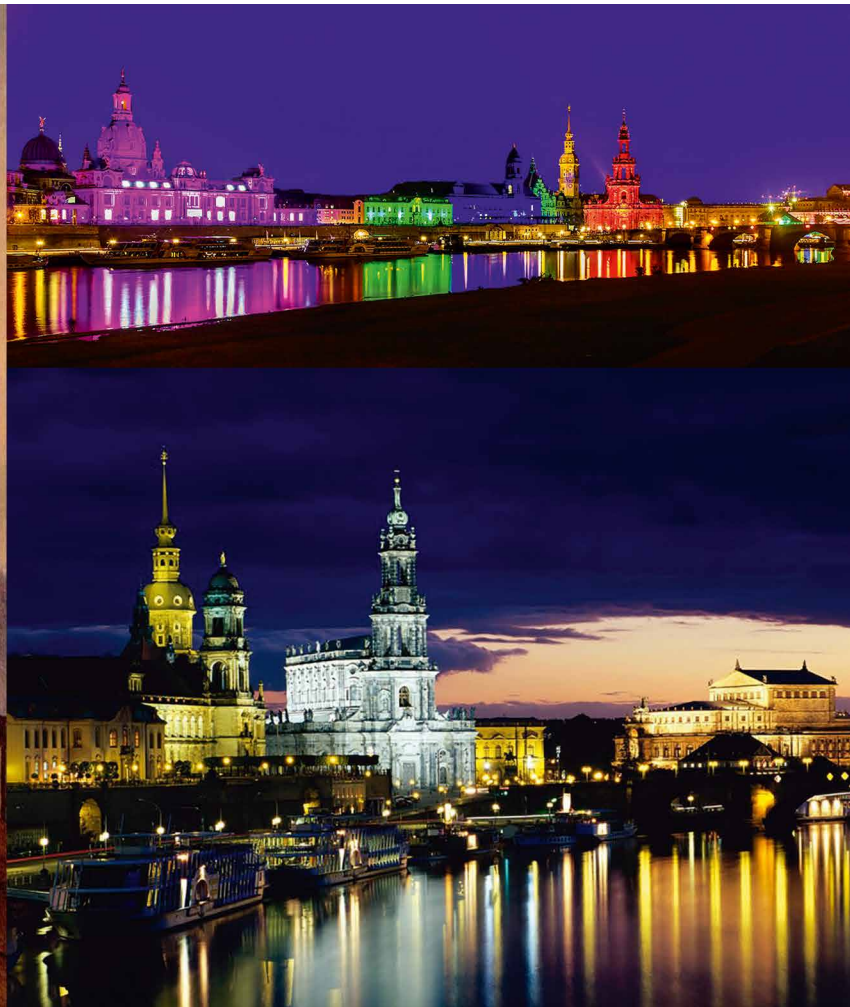
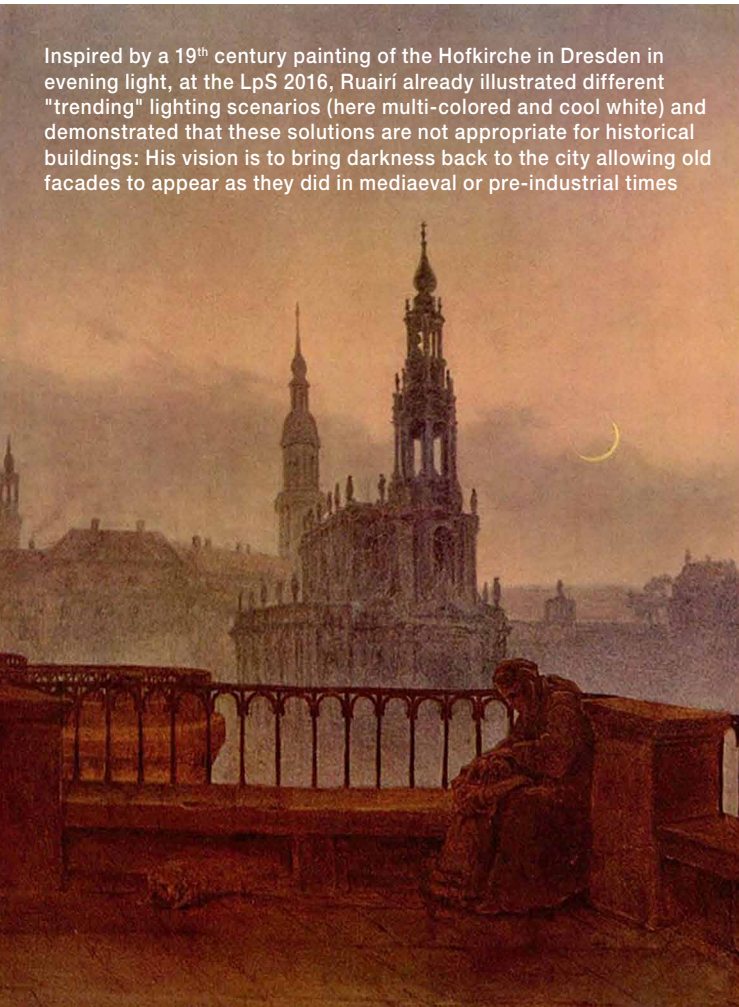

# Micro-Optics for Efficient LED Spotlights with Arbitrary Farfield Distributions

Research and development of micro-optics has advanced with the introduction of LEDs that were in parallel with new micro-optics manufacturing technologies and new optical materials. They offer many advantages over conventional optics, especially when it comes to product design. This year's winner of the prestigious Scientific Award proposed a very special approach. The team of Dr. Peter Schreiber and Dr. Christoph Waechter at Fraunhofer IOF researched the opportunities and producibility of a clever adaptation of the fly's eye condenser, aka Koehler Integrator, which was developed and IP protected in 1928 by Zeiss Ikon AG. In their winning paper, they explain the theory, show simulations and provide the measurement results from demonstrators.

Common tertiary optics for collimated LED light sources are diffusers for simple rectangular or elliptic farfield distributions, which result in enlarged etendue and thus increased lamp size for a given beam divergence. Replacing diffusers by aligned, double-sided microlens arrays with buried slide structures enables realization of etendue conserving spotlights for arbitrarily shaped and structured illumination - but this has to be paid for by decreased system transmission. A first commercial application of this design, referred to as arrayed projector, is the exterior luminaire of the BMW Welcome Light Carpet presented at IAA 2015.

We present a further development of this design approach for spotlights, which employs irregular, aligned, double-sided microlens arrays in a fly's eye condenser arrangement omitting the buried slides. This allows for arbitrary intensity distributions, etendue conservation - and thus

minimum system size - together with high transmission. Variable farfield distributions can be realized by individually switching of arrayed LEDs provoking controlled array channel crosstalk.

Realization of the irregular lens arrays starts with design by raytracing, which has to deal with a large number of individual lenslet sizes and decentrations relating to the respective apertures. In the next step lenslet data are transferred to the mastering process. This is carried out by grayscale lithography. From the master profiles tandem lens arrays are replicated by UV-reaction-molding. The aligned, double-sided polymer-on-glass optics wafers are then diced, to obtain the optics chips with typical sizes between about one and hundred  $\text{cm}^2$ . This process is available from several commercial suppliers. The potential of this spotlight technology is demonstrated by different samples, which realize

a passing beam and a segmented driving beam of an automotive headlamp. Important advantages of the presented design approach are high transmission, smallest unit sizes because of etendue conserving beam shaper design and system length shortening by multi-channel architecture, variable switch- and dimmable farfields and design freedom for realization of nearly arbitrary spotlight exit aperture shapes.



Introduction

LED light source optics are often based on a "first collimation then beam shaping" approach, which corresponds to the usual nomenclature for LED optics components (Figure 1): Primary optics (e.g. dome, cover glass or reflector) are part of the LED housing, which help to gather as much light as possible from the chip. Most secondary optics are collimators e.g. refractive or TIR condenser lenses, which bundle the emittance from the LED. Tertiary optics are employed for shaping the output of the secondary.

The most widespread type of tertiary optics are diffusers, which can be realized as e.g. simple ground glass or holographic elements. The basic optical behavior of such diffusers is shown in figure 2.

According to its farfield distribution (e.g. homogeneous or gaussian) the diffuser spreads the light around the angle of incidence of the incoming beam. Thus, the output farfield always depends on the incident angular distribution and the etendue of the exiting bundle is enlarged compared to the input etendue (EQ1).

$$E = \pi \cdot n^2 \cdot A \cdot \sin^2\theta \quad (EQ1)$$

with

refractive index  $n$   
 bundle area  $A$   
 divergence half angle  $\theta$

This hinders system miniaturization. Diffusers are inappropriate for farfields with strong intensity gradients like sharply contoured tophat distributions or structured illumination (e.g. stripes or points), because the incident divergence limits the achievable intensity gradients. Double sided, aligned, arrayed micro-optics help to overcome these limitations.

Fly's Eye Condenser

The fly's eye condenser (FEC) - also referred to as Köhler integrator -

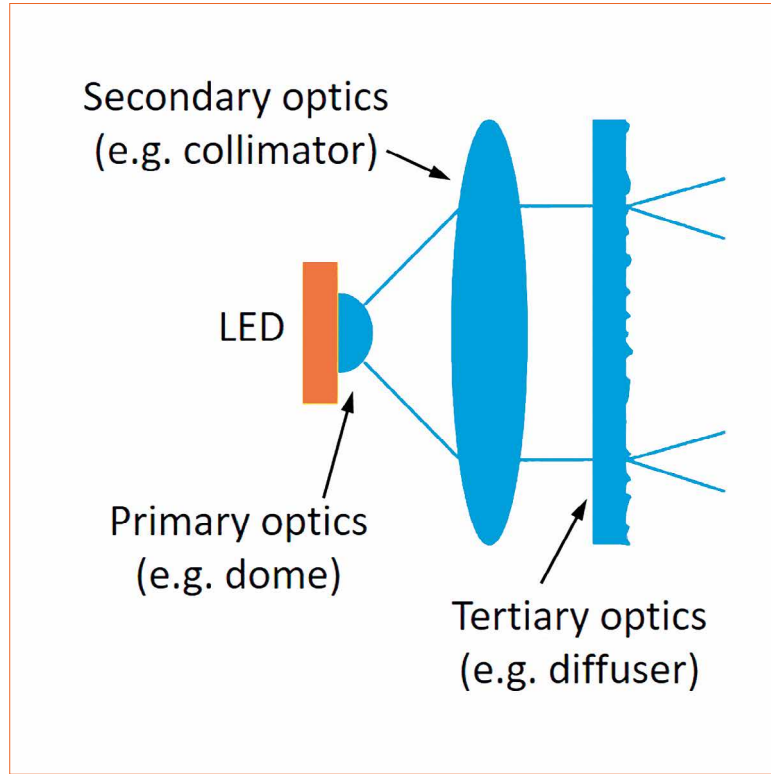

Figure 1: LED optics nomenclature

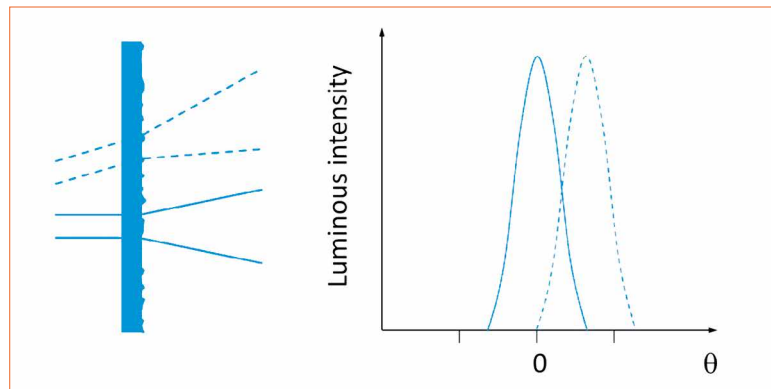

Figure 2: Diffuser with two beams with different incidence angles (left). Different incidence angles result in shifted farfield distributions (right)

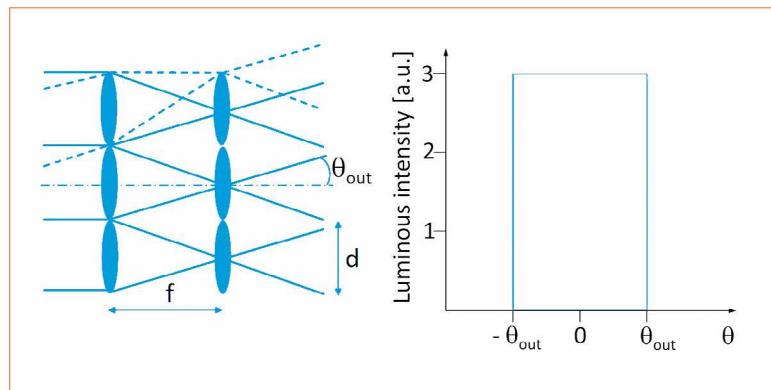

Figure 3: Fly's eye condenser (FEC) optics scheme (left) and resulting farfield (right). The dotted ray path shows incidence at maximum acceptance angle

consists of two identical lens arrays, set apart from each other by one focal width (Figure 3).

The FEC produces a homogeneous tophat farfield distribution with a full divergence angle of  $2\theta_{out}$  corresponding to the numerical aperture of the array

$$NA = \sin \theta_{out} = \sin(\text{atan}(d/2f))$$

as long as the incidence angle is within the accepted angular range, which equals  $2\theta_{out}$ . This means, the FEC acts as beam shaper, which produces a homogenized farfield independent from the incoming angular distribution. In

**Figure 4:**  
Arrayed projector (AP) with an aperture mask layer buried under the entrance lens array (left) and resulting farfield (right)

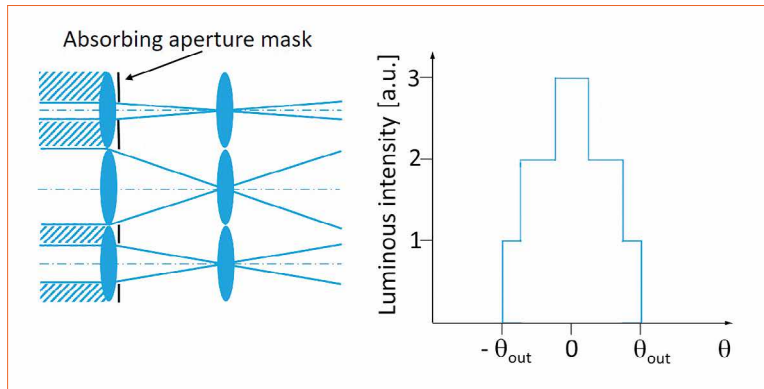

case of maximum incident divergence equal to  $\theta_{out}$  (Figure 1, dotted ray path) the fly's eye condenser conserves etendue [1], which is a requirement for minimum lateral system dimensions. For incidence angles larger than the acceptance angle channel crosstalk occurs. This results in a farfield distribution, which is shifted by  $2\theta_{out}$  w.r.t. the regular farfield. This unwanted, crosstalk generated farfield distribution is immediately adjacent to the regular farfield in angular space. The shape of the illuminated distribution corresponds to the shape of the apertures of the entrance lenslets. Thus, preferred applications of FECs are rectangular, hexagonal and circular homogeneous farfields or 1D-homogenization with cylindrical lenslets, which enable array geometries with high fill factor and high transmission.

### Arrayed projector

To enable realization of not only homogeneous but arbitrary farfield distributions, a slide array realized e.g. by a Cr aperture mask is buried under the entrance microlens array. This is the basic optics scheme of

the arrayed projector (AP, Figure 4) realizing Köhler illumination [2]. This optics scheme was employed e.g. for the structured illumination of the BMW Welcome Light Carpet, first presented with the BMW 7 at IAA 2015. The achievable number of graylevels in the farfield corresponds to the number of lenslets of the array. The AP offers independence from incidence angle and etendue conservation analogous to the FEC as well as structured illumination and arbitrary farfield intensity distributions – but this has to be paid for by system transmission: The light in the hatched areas of figure 4 is blocked, which not only lowers system transmission remarkably but also causes unwanted heating of the lens array.

Unfortunately, in case of farfield distributions with large angular extent around a small hot spot e.g. an automotive low beam pattern the resulting fill factor of the apertures and thus the transmission is comparatively low. The achievable farfield distribution of the AP is restricted to the angular range  $[-\theta_{out}, \theta_{out}]$  of an equivalent FEC with the same lenslet numerical aperture.

**Figure 5:**  
Irregular fly's eye condenser (IFEC) optics scheme (left) and resulting asymmetric farfield (left)

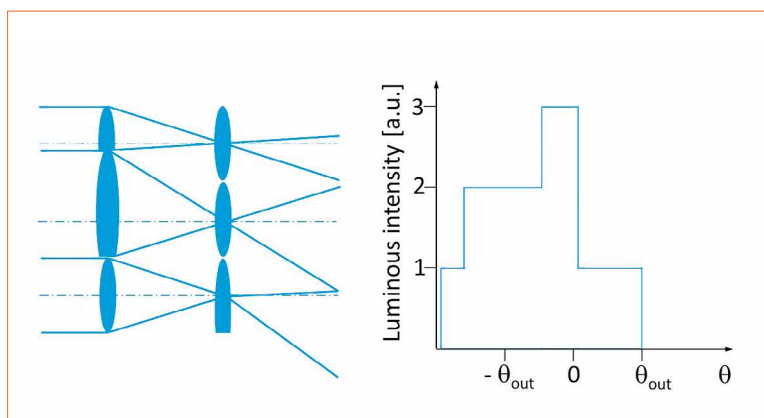

A related approach for mask-based shaping of a low beam distribution was presented in [3]. Here the mask array is located in a larger distance from the entrance lens array similar to a projector with defocused critical illumination. While this enables refractive beam pre-shaping for enhanced transmission through the mask, it prevents etendue conservation and hinders homogeneous illumination of the slide structures.

### Irregular fly's eye condenser

Starting from the considerations described above our goal is the development of double-sided micro-optics, which combines the advantages of both FEC (high transmission, etendue conservation) and AP (arbitrary farfield profiles) and avoids the expensive and thermally critical buried aperture layer. The proposed irregular fly's eye condenser (IFEC) scheme shows two basic modifications with respect to the common regular FEC (Figure 5):

First, size and center position of the apertures of the entrance lenslets may differ from channel to channel (i.e. variable array pitch). In case of lenslet apertures, which are decentered w.r.t. the channel axis, the lenslets have to be realized as decentered lens segments, to focus incoming light to the center of their dedicated exit lenslet aperture (center and top channel in Figure 5).

Second, while the exit lens array has constant pitch and aperture sizes like the regular FEC, it may include decentered lenslet segments, which enable additional angular steering of the channel's exit bundle (downward steering in the bottom channel in Figure 5).

The individual tophat farfields of the various array channels are superposed to form a quasi-continuous intensity distribution [4]. To achieve high system transmission, the irregular fly's eye condenser (IFEC) requires a high fill factor entrance array. This can be realized e.g. with rectangular, hexagonal or

hexagonally arrayed circular lenslets or alternatively for 1D-beam shaping with cylindrical lenslets. The iFEC offers the same acceptance angle as the conventional FEC and conserves etendue accordingly, but enables realization of even larger output divergence of more than  $[-3\theta_{out}, 3\theta_{out}]$  and nearly arbitrary farfield distributions.

Designing an iFEC means search for a set of individual array channels which approximates the aimed farfield distribution together with an optimal space-filling arrangement for the entrance array. A further requirement is minimization of sag-height differences between neighbored lenslets, to avoid straylight generation. An additional constraint from manufacturing technology is realization with an as small as possible number of different channels, to facilitate array master generation. The aspired low number of different individual array channels results in a cluster of nearby channels, which form the fundamental unit of the iFEC. This unit is then multiplied in a step-and-repeat like manner, until the required exit window area of the iFEC is achieved.

### Micro-Optics Manufacturing

The micro-optical iFEC elements are fabricated in a two-stage process, which starts with array master generation by grayscale lithography. Unlike commercial UV-laser scanning exposure tools our homemade grayscale lithography equipment employs a 405nm LED-illuminated LCoS micro imager, which is imaged demagnified onto the photoresist coated master glasswafer [5]. The combination of highly-dynamic dose and exposure time control and a multiple exposure regime enables realization of diffraction limited lenslet profiles up to sag heights of more than 50  $\mu\text{m}$ . Typical lenslet aperture diameters range between less than 100  $\mu\text{m}$  and several 100  $\mu\text{m}$ . Figure 6 shows examples of realized master profiles.

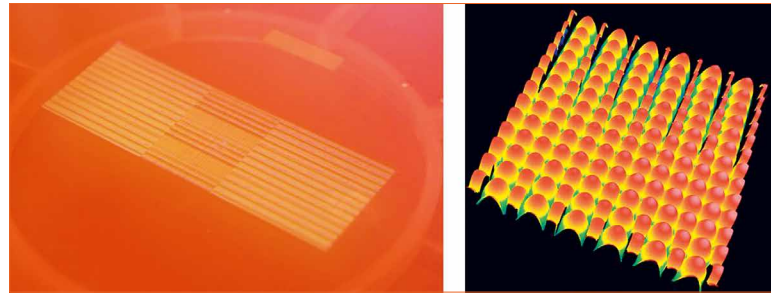

**Figure 6:** Grayscale master profiles. Low beam demonstrator master wafer (left) and white light profilometry of high beam demonstrator entrance microlens array (right)

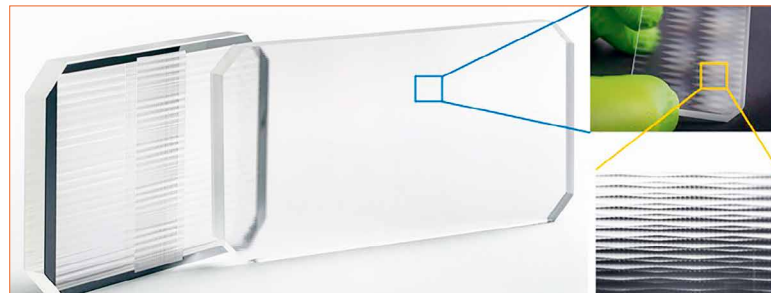

**Figure 7:** Replicated polymer-on-glass elements. Low beam tertiary optics with residual Cr masks (left) and high beam optics (right)

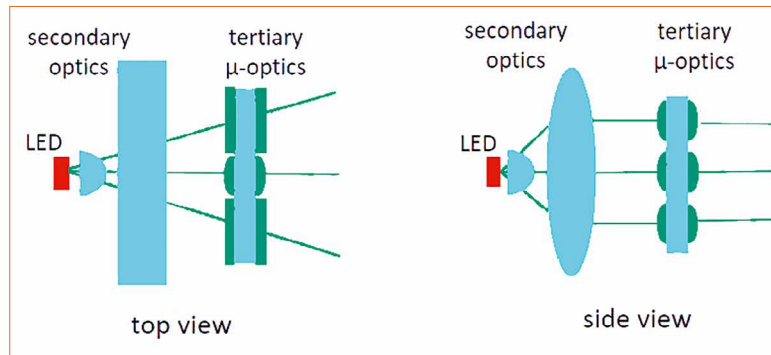

**Figure 8:** Low beam demonstrator basic optics scheme. The top view (left) shows the arrangement of the three different iFEC segments

In the second step double-sided polymer-on-glass elements are replicated from these master profiles by UV-reaction-molding of polymer onto a glass wafer [6]. Optionally residual Cr-mask structures are buried underneath the entrance lenslets to suppress straylight or to support the generation of extremely odd shaped farfield distributions (e.g. for the center kink in the brightness cut-off of an automotive low beam). By using a mask-aligner for the replication process, a very precise adjustment of the two lens arrays at the opposite sides of the glass wafer w.r.t. each other with decentration of only few micrometers is achieved. After the wafer-scale replication process the polymer-on-glass elements (Figure 7) are singularized by a wafer dicing saw. For demonstrator realization the whole micro-optics manufacturing process chain is available, while several commercial suppliers offer high volume replication capabilities.

### Demonstrators

The versatility of the introduced iFEC architecture for LED tertiary optics is illustrated by demonstrators for the low beam and the segmented high beam of an automotive headlamp.

#### Low beam

The required farfield consists of a hot spot with strongly asymmetric vertical intensity distribution: A sharp intensity cut-off at the top prevents dazzling of oncoming traffic, while a smooth distribution downwards illuminates the road in front of the car. The basic optics scheme of the low beam demonstrator is shown in figure 8.

It employs a LED followed by an anamorphic collimator, which collimates in vertical direction but only decreases divergence in horizontal direction, to approximate the desired horizontal intensity distribution. The subsequent iFEC tertiary optics consists of three

**Figure 9:**  
Construction of the low beam demonstrator (only left module shown equipped with optics)

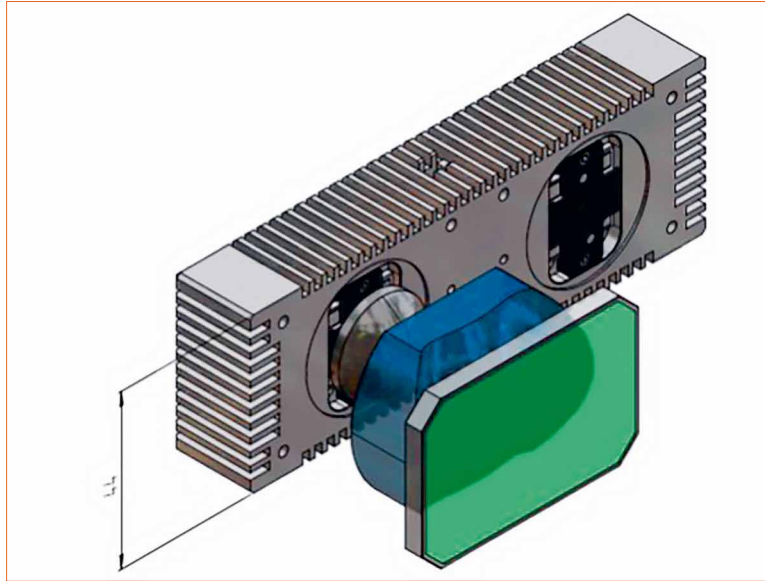

**Figure 10:**  
Low beam demonstrator with a 2€ coin for comparison. Micro-optics is removed from the right module, to show the anamorphic collimator



**Figure 11:**  
Luminance camera photograph of low beam farfield

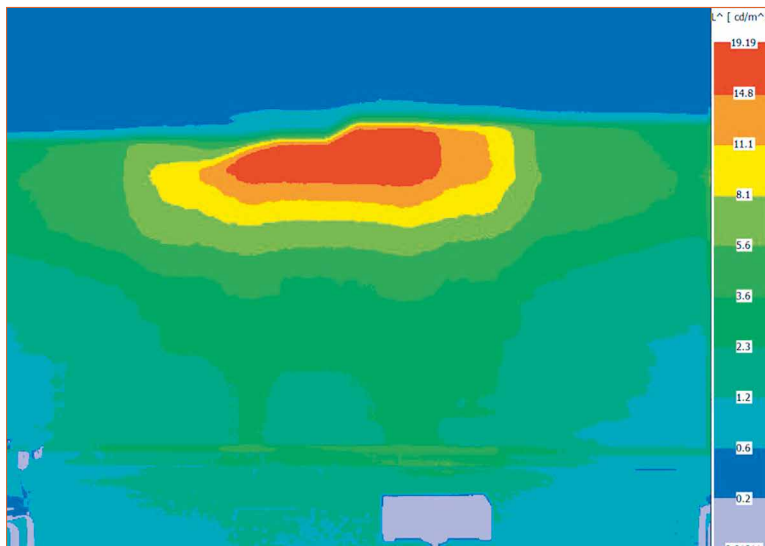

different segments: Two cylindrical iFECs produce the horizontal brightness cut-offs slightly below or above horizon, left and right to the driving direction, respectively. The third center segment is an iFEC consisting of aspherical

lenslets with rectangular apertures and a buried, residual aperture mask. The minimal absorptive regions of this mask generate the central elbow-shoulder cut-off region according to automotive ECE regulations and suppress straylight.

The low beam demonstrator (Figure 9) occupies a volume of  $W \times H \times D = 130 \times 44 \times 70 \text{ mm}^3$  and consists of two identical modules, each equipped with a two-chip LED OSRAM OSTAR Headlamp Pro. We use a two-lens collimator with a stock catalogue aspherical glass field lens and a custom-made anamorphic, acylindric collimator, which was directly diamond turned into polymer (Figure 10).

The achievable optical system transmission is about 65% using AR coated components plus an uncoated exit window (not shown in Figure 9 and Figure 10). Characterization was carried out by luminance camera inspection of the farfield on a screen at 10 m distance from the lamp (Figure 11). Visible artifacts in the recorded distribution result mainly from reflections at floor, walls and ceiling of the room. The maximum achievable luminous intensity is about 35 kcd according to ECE standards.

The useful light characteristics of the low beam demonstrator together with the achieved compact system dimensions are very encouraging, but problems with straylight artifacts are still present. The main source are light portions arising from the entrance lenslet rims, which generate channel crosstalk. This leads to horizontal lines in the dark area above the cut-off. In a first approach slightly increased Cr mask areas shall help, to improve straylight suppression by sacrificing only a negligible part of system transmission. Further development of design and mastering technology will result in a completely mask-free system layout.

### High beam

Differently from the low beam the high beam has to produce a more symmetric farfield, which consists of a horizontal array of individually switchable vertical stripes like a picket fence. The basic optics scheme of the high beam demonstrator is shown in Figure 12:

A horizontal LED array is followed by a two-lens secondary collimation optics and a tertiary iFEC optics with rectangular lenslets for beam shaping. Buried aperture layers are not required. Each LED addresses a particular combination of entrance and exit lenslets: The center LED illuminates the tandem array in regular manner, i.e. opposite entrance and exit lenslets form an array channel, while off-axis emitters of the LED array cause intentional channel crosstalk to next or farther away neighbor exit lenslets. Thus, switching of horizontally adjacent segments in the farfield is simply achieved by appropriate driving of the LEDs.

The high beam demonstrator consists of two identical modules, each with a size of  $W \times H \times D = 88 \times 44 \times 112 \text{ mm}^3$  (Figure 13). In the concrete demonstrator 12 OSRAM OSOLON compact LEDs per module are employed, arranged as vertically stacked pairs for the 5 inner LEDs and single LEDs for the two outmost positions. The collimators consist of a stock catalog aspherical field lens and a diamond-turned collimation asphere.

The overall clear aperture of each beam shaper is  $80 \times 40 \text{ mm}^2$ . The apertures of the entrance array have constant width but variable heights of  $180 \times 45 \dots 315 \mu\text{m}^2$  (Figure 14, right), while the exit array is formed by regular square lenslets with  $180 \mu\text{m}$  pitch. Lenslet focal width is  $3.4 \text{ mm}$ . Each module projects segments with  $3^\circ$  horizontal extent. A slight overshoot of the edges of the horizontally arranged tophat segments (Figure 15) results from imperfect lenslets profiles (e.g. dead spaces between neighbored lenslets) and diffractive effects [7]. The larger vertical farfield distribution in the center results from intentional next neighbor vertical crosstalk caused by the larger vertical extent of the center LED pairs.

With a  $1.5^\circ$  rotated setup of the two modules w.r.t. each other a  $1.5^\circ$  segmentation of the horizontal farfield with the switched off segments

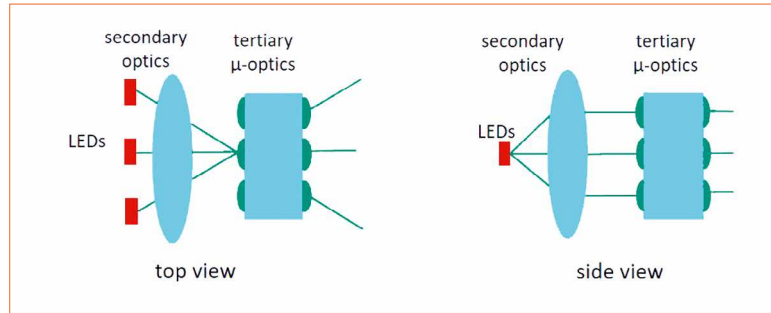

**Figure 12:** Segmented high beam demonstrator basic optics scheme

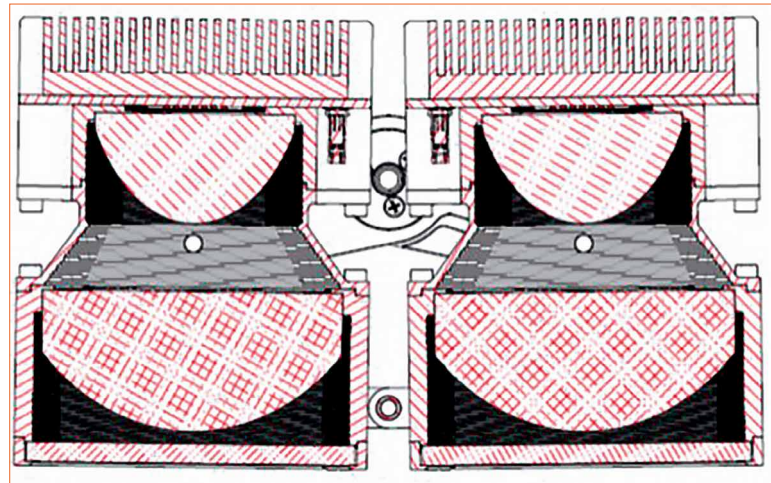

**Figure 13:** Construction of high beam demonstrator

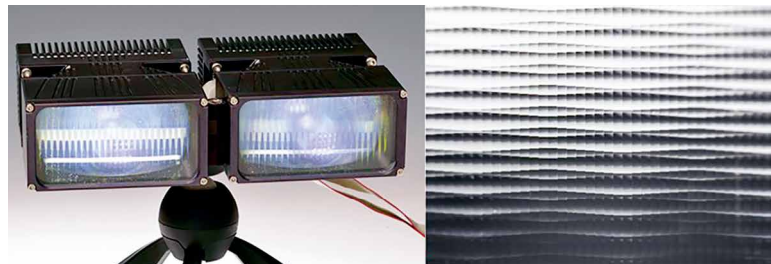

**Figure 14:** High beam demonstrator. System photograph (left) and microscopic photograph of detail of iFEC entrance lens arrays (right)

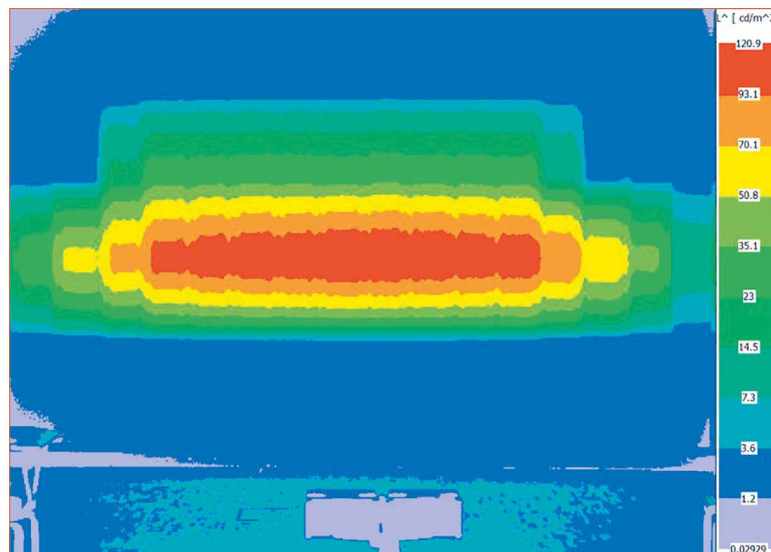

**Figure 15:** Luminance camera inspection of fully illuminated high beam demonstrator

surrounded by segments with half brightness is realized (Figure 16).

Maximum achievable luminous intensity of more than  $50 \text{ kcd}$  ensures headlamp performance

exceeding ECE regulations. Comparatively low system transmission of less than 40% results mainly from the design goal of a very low exit window height. Use of better suited LED geometries

**Figure 16:**  
High beam with one  
switched-off segment,  
surrounded by two  
half-bright segments

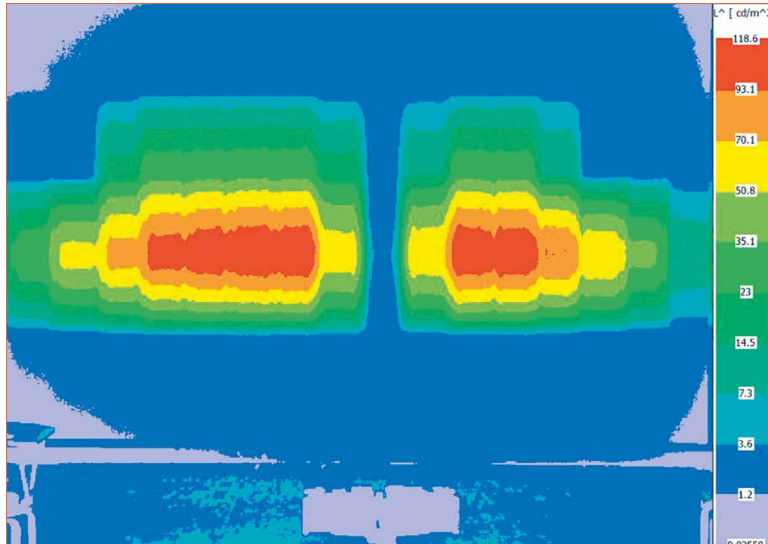

(e.g. rectangular LEDs) enables even smaller exit window heights and/or remarkable improvement of transmission and thus e/o-efficiency.

### Conclusions

We introduced the irregular fly's eye condenser (iFEC), an etendue-conserving beam shaping optics, which combines the advantages of the regular fly's eye condenser (high transmission, etendue conservation) and the array projector (arbitrary farfield distributions). Contrary to the absorption mask based farfield patterning of the array projector a completely mask-free realization is possible. This simplifies and cheapens system realization and

enhances transmission remarkably. Nearly arbitrary 1D and 2D farfield distributions are generated.

The manufacturing of the micro-optical elements is based on grayscale lithography for mastering and UV-molding for replication as precisely aligned, double-sided polymer-on-glass elements. While mastering is quite challenging, the replication process is well established and available from several commercial suppliers. The comparatively low flux densities at the micro-optical components together with advanced polymer materials and well-established replication technologies enables an optimistic forecast for a long operational lifetime.

Design modifications of the iFEC for relaxation of alignment tolerances offer prospects for realization not only as polymer-on-glass elements but monolithic plastics parts with less precise, cost-efficient replication technologies like injection molding and hot embossing.

We demonstrated different use cases for the iFEC architecture for simple and anamorphically collimated LED light sources employing circular and/or cylindrical iFECs with and without extra buried mask layer. Controlled channel crosstalk in the iFEC enables switchable farfield patterns. The realized segmented high beam and the low beam demonstrator show their potential for miniaturized headlamps with high e/o efficiency and new degrees of freedom e.g. for the artistic lamp design with nearly arbitrary spotlight contours. While ECE regulations are fulfilled, straylight issues are still present. Design modifications and improved mastering technology will help to overcome these shortcomings.

The presented demonstrators clearly target the automotive sector, but the iFEC beam shaping architecture might find application in many other fields e.g. general illumination, stage and shop lighting, signaling, pattern projection for measurement and surveillance. ■

### Acknowledgements:

The authors like to thank Chen Li, Dirk Michaelis, Stephanie Fischer, Robert Leitel, Peter Dannberg, Marko Stumpf, Sylke Kleinle, Antje Ölschläger, Ralf Rosenberger, Rohan Kundu and all staff members of micro-optical systems department of Fraunhofer IOF for pleasant and open-minded collaboration, our former colleague Marcel Sieler for his significant contributions in the early years of array projector development and the Fraunhofer Society for supporting this work in the framework of the internally funded project "WISA SSL2 – StructuredSpotLight".

### References:

- [1] P. Schreiber, S. Kudaev, P. Dannberg, U.D. Zeitner, "Homogeneous LED illumination using microlens arrays", Proc. SPIE 5942 (2005) 59420K
- [2] M. Sieler, P. Schreiber, P. Dannberg, A. Bräuer, A. Tuennermann, "Ultraslim fixed pattern projector with inherent homogenization of illumination", Appl. Opt. 51 (2012) 64-74
- [3] S. G. Hackl, B. Mandl, B. Reisinger, A. Moser, "Micro projection arrays for automotive front lighting systems", Proc. of ISAL Vol. 17 (2017) 263-70
- [4] Ch. Li, P. Schreiber, D. Michaelis, Ch. Wächter, St. Fischer, "Etendue conserving light shaping using microlens arrays with irregular lenslets", Proc. SPIE 10693 (2018) 1069304
- [5] R. Leitel, St. Fischer, P. Dannberg, S. Kleinle, P. Schreiber, Ch. Wächter, "Evaluation of lenslet fabrication technologies for micro-optical array projectors", Proc. SPIE 10692 (2018) 1069206
- [6] P. Dannberg, F. Wippermann, A. Brückner, A. Matthes, P. Schreiber, A. Bräuer, "Wafer-Level Hybrid Integration of Complex Micro-Optical Modules", Micromachines, Vol. 4 (2014) 325-40
- [7] A. Buettner, U. D. Zeitner, "Wave optical analysis of light-emitting diode beam shaping using microlens arrays", Opt. Eng., Vol. 41 (2002) 2393-401

# Trends in Lighting

September 22–24, 2020  
Opera House Bregenz



For  
Architects  
Lighting  
Designers  
Planners  
Investors

**Call for  
Speakers**  
Deadline  
Feb 15, 2020

4th International Trends  
in Lighting Forum & Show

[www.TiL2020.eu](http://www.TiL2020.eu)

Lps 2019  
LED BY DESIGN  
MARCH 14-15, 2019

TIL

Experience  
the Future  
of Light

Technology  
Design  
Connectivity

Intel  
Microsoft  
LIFEd  
TRACOM  
SILMAR  
TRIDONIC  
LUMINANCE  
LUMINANCE

Lighting an  
Mark Ridler  
Lighting Director





# LpS & TiL 2019 Post Show Report – Focus on Applications and New HCL Ideas

2019 has been a year where many lighting events struggled and some even had to cancel their shows. Fortunately, this was not so for LpS and TiL, which were perceived positively and well visited. Knowledgeable attendees who contributed with interesting thoughts and ideas avowed the program, made up of different sessions put together by the team around the event organizer, Siegfried Luger. Exhibitors benefited from these high-quality attendees who asked the right questions and showed sincere interest in their products and services. As in the past, it was not easy for Arno Grabher-Meyer, Editor-in-Chief of LED professional to decide which of the many interesting event highlights to cover in order to give an all-encompassing overview.



Bigger, faster, higher! These are attributes that, in many respects, dominate our world and our thinking. Some of these attributes have also found their way into lighting.

**Bigger:** Increasing light pollution is often attributed to LEDs as the number of outdoor luminaires increases due to lower maintenance costs.

**Faster:** As many luminaire manufacturers have learned the hard way, the speed of lighting development has gained momentum, requiring shorter and shorter product cycles.

**Higher:** Expectations of the users has gotten higher, perhaps too high, leading to disappointment and in some cases, frustration.

Whether or not these statements are true they are in the minds of the consumers and have thrown the lighting industry into troubled waters. This has become especially evident at conferences or fairs over the past few years. And at LpS/TIL?

## Bigger, Faster, Higher - The Meaning for LpS & TIL

In contrast to the gloomy picture before, the LpS 2019 left behind the positive impression that bigger, faster and higher, in the conventional sense, are terms of the past. These attributes have taken on an optimistic and positive meaning due to the positive spirit on display on the show floor as well as in various lectures.

Let's start with "bigger": The awareness of different problems facing the lighting community and the lighting industry has gotten bigger. But their readiness to improve and react to these problems has also gotten bigger. And this is the moment when "faster" enters the courtyard. A good part of the luminaire industry has been able to catch up and cope with the speed of the semiconductor industry and, more importantly, to take advantage of it, or at least to be aware of it. They are, or will soon be, able to follow new requirements faster than before, and they are ready to improve or adapt their products quickly if the client asks them to. However, the big guys may have something to learn from the quicker startups. Lastly higher: Higher efficiency is still a topic when it comes to high quality lighting. High CRI light sources and light sources with spectra that copy the properties of sunlight are still not as efficient as desired. There is further potential, although the products improved significantly over the years and the industry is expending effort to improve. In general, product quality and light quality is higher than ever before and is

continuously increasing. Also, the education level in the light community is higher, resulting in followers of the pioneers and masterminds who were paving the way to correct some undesired negative tendencies of the past years, as mentioned above.

Don't get me wrong. The era of bad light is not automatically over. Not all problems have been solved and it is not all easy going. Otherwise Jan Denneman's "Good Light Group" would have nothing to do and CIE, EPIC, Zhaga or DiiA, LightingEurope, the LIA, GLA and other organizations would be obsolete. But the talks and experiences at the show absolutely suggest that a good part of the community is taking it seriously and working hard to improve and change lighting for the benefit of mankind, nature and the environment. This report will include many examples that underline this new spirit. Or perhaps I should say the re-centering of the community of their duty, pertaining to the meaning of lighting and their primary skills after years of turbulence, trial and error. Read on and draw your own conclusions.

## Findings from the Keynote Session

### Mark Ridler, Lighting an Idea

"It all starts with an idea," was the opening sentence to Mr. Ridler's keynote. He went on to state that it is important to search for the right idea, and knowing the stakeholders, the use, and purpose, are basic requirements. He also said that in the end, a thorough and honest evaluation of one's own work

Keynotes Q&A, moderated by Sarah Toward. Mark Ridler, Horst Rudolph and Keith Bradshaw gave outstanding answers to the questions from the audience



## IMPRESSIONS FROM LPS & TIL

◀ "It all starts with an idea!"

"What are the important requirements for lighting of the future? Efficiency, health, comfort or intelligence?"

▶ "It is important to understand the nature of light, to understand how people experience light, to understand how the lighting scene of a project may change over time, and to educate and convince people"

is needed. After briefly explaining the stakeholders and their possible requirements, he demonstrated the diversity of his business, showing examples of his work: The UK Pavilion of Milan 2016, the BioCity Center Nottingham, Paddington Station, the University of Central London (UCL), Smythe Library at Tonbridge School, the Live Securities Ltd. HQ or the Boxpark Retail Center. As different as these projects are, the requirements and the challenges are also different. Starting from being artistic with supporting a statement without disturbing the atmosphere to creating a transit and meeting zone without disturbing light poles, or from sustainability and daylight utilization, supporting quality light for reading day and night, to communicate brand philosophy and compliance with the stringent BREEAM and WELL standards versus lighting for a dynamic multi-purpose space to increase occupation. All these dissimilar projects have in common is, "it all starts with an idea", and beyond this, high quality illumination often combined with requested sustainability thoughts. Not necessarily always backed by a huge budget, as Mr. Ridler confirmed when answering a question from the audience!

### Horst Rudolph, LEDification and Connectivity are Changing the Lighting Industry

After some general information to clarify the current situation and status of the lighting business, Horst Rudolph made some really interesting points and remarkable statements when answering the question: "What are the important requirements for lighting of the future? Efficiency, health, comfort or intelligence?"

**Efficiency:** While the expected efficacy improvement of the light source will only amount to 6% over the next few years, the overall potential is huge when adding controls and intelligence to the system.  
**Health:** Individualization, quality and dynamization of light following the example set by nature seem to be the key elements. Biological aspects need to be considered but still require research.  
**Comfort:** This means comfort for the different stakeholders. While standards are available for conventional lighting, they are missing for dynamic lighting. New tools for lighting planners and designers for dynamic lighting are required as well as new tools for building integration and commissioning. Last but not least, the individualization for

users, UI and UX need to be improved. Intelligence: Sense - reason - act, as basics, can be improved by extending communication to external non-lighting elements and, in the end, probably artificial intelligence. Even more remarkable were his remarks about users who show increasing awareness of light quality and sustainability. The demonstrated examples for modern lighting, The Tube warehouse with a BREEAM score of 99,4% and the Futurium Berlin with a B+B Gold score of 89% tell their own tale: Sustainability and light quality are key!

### Keith Bradshaw, Designing with Light – Day and Night

Keith Bradshaw emphasized that he wanted to talk about the application and started with a short introduction of the profession, the challenges and the position between architects, engineers and luminaire manufacturers. He pointed out how important it is to understand the nature of light, to understand how people experience light, to understand how the lighting scene of a project may change over time, and educate and convince people. He also emphasized the benefits that LEDs have, at least theoretically, as he added, and expressed the importance of natural light as an inspiration. Then he showed a number of projects to explain and support these statements. He presented a simulation tool that allows a live demonstration of the planned lighting project where almost any light parameter can be changed, including full color changing, which, in the used example he said looks awful and helps to explain that it is not a good idea for an application. An even more detailed picture of the profession and his work was the example of illuminating an older, mature area in Hong Kong: Understand the place, learn how people live there and what they do over time, measure illuminance levels and take into account the possible changes over time, for example, because of growing trees. This was the most relevant advice he gave. How did he come to this information in practice? They basically tried to live there for a number of weeks! He closed his lecture with another project in Hong Kong where he illuminated a promenade at the Victoria Harbor. As most of the presented projects were illuminated facades, a question of environmental impact was unavoidable. Mr. Bradshaw stated that today customers and lighting professionals should make sure

a project is really feasible and sends out the right image and corporate statement in regards to sustainability, because light is visible energy!

### Lessons Learned

Both lighting designers as well as industry are well aware of environmental issues and user requirements, and are ready to act, as their examples and statements demonstrate. In regards to technology, the combination of data and light is most interesting for them as it allows us to learn more about the true needs of users and to adapt light better to their needs. This, in turn, would lead to true human centric lighting.

### Findings from the LpS & TiL Award Submissions and the Show Floor

Exhibitors from established companies as well as startup company exhibitors applied for awards in different categories while the scientific institutes applied for the "Best Scientific Paper Award". LpS and TiL, each awarded three prizes and a submission from two cooperating startups was also honored. Two thirds of the submissions were concerned with developments and products that could either have a noticeable, positive effect on the environment, sustainability, or HCL, beyond just being a few lumens per watt more efficient. It came as no surprise that most of the award winners scored points in these regards. Let's have a look at who the winners are, what they submitted and why the jury decided in their favor.

### The LpS Awards

It didn't come as a surprise that Seoul Semiconductor proposed their SunLike technology even though the underlying technology was already introduced at Light + Building 2016 by SSC's partner, Toshiba Materials, as TRI-R technology [1,2]. While they used the well-known arguments of providing a spectrum that emulates the spectrum of the sun in the visible range nearly perfectly and also pointed out the resulting benefits for HCL, agriculture lighting and other applications, the main reason the jury bestowed the "Best Lighting Technology Award" on SSC was that they don't just claim benefits but they strive to prove the benefits and to clarify which benefits, exactly, can be provided by

## IMPRESSIONS FROM LPS & TIL

► The 6<sup>th</sup> LED professional Scientific Award was awarded to a research group. As in other years, the winners seemed to be surprised. Here: Dr. Peter Schreiber proudly receives the honor, the trophy and the check



◀ Nichia received the Best Sustainability Technology Award for their brand new "2-in-1" Tunable White LED with Single LES

scientific research, e.g. with works from Prof. Christian Cajochen or Dr. Octavio Perez. Furthermore, the jury was convinced that by setting a milestone with this concept, SSC's SunLike is leading us to a new era of HCL in LED lighting.

The decision to assign the "Best Application Technology Award" to GL Optic for their GL RID one UV measurement system may be surprising. But when you consider that this award was created to honor more than just lighting applications, the decision is easy to understand: Integrating UV in lighting applications has become a new trend for some specific tasks and is not just limited to a few industrial process applications, anymore. Disinfection of workplaces with under-cabinet lights is just one example. Therefore, the accurate measurement of the angular distribution of UV light is also of interest. That's exactly what GL Optic's GL RID one UV provides.

The "Best Sustainability Technology Award", (and I would like to mention here, that it is my personal favorite, as it combines all required attributes including light quality with sustainability), was allotted to a brand-new product: Nichia's "2-in-1" Tunable White LED with Single LES. While also being a serious contender for the "Best Lighting Technology Award" with its features, the jury especially wanted to emphasize the remarkable achievement of Nichia in regards to supporting sustainable high-end solutions. The technically unique product offers an almost constant overall efficiency of about 170 lm/W in a wide CCT tuning range from 2700 K to 6500 K providing a constantly high CRI of 90+. The tiny package size of 3x3 mm and the single LES allow compact designs that require less resources in conjunction with outstanding light quality.

### The TiL Awards

This year, Samsung Electronics received the "Best Lighting Solution Award" for an application that doesn't directly concern general lighting. The PixCell LED is a system that allows more accurate separation of the individual pixels by reducing the optical interference to a minimum. This improves the contrast ratio and as a consequence helps to minimize glare in High Definition Adaptive Driving Beam applications. While until today, adaptive driving beam headlights are mainly used in luxury cars, the jury honored this improved lighting solution for automotive

because it could change the situation. In addition, the jury noted that they also recognize some potential applications in general lighting.

Lumitronix is the winner of the "Best Lighting Project Award" with their submission "Lumitronix – Office Lighting with Belux's Koi S Luminaire Using Vitasolis Technology". Biologically effective light, often included in the term of Human Centric Lighting, has gotten a lot of attention within the last years as it influences the circadian rhythm, alertness and other psychological and physiological mechanisms in humans. The key for these effects is the presence or absence of the cyan light spectrum. Unfortunately, filling this gap with conventional methods causes either insufficient CRI or poor efficacy. Using Nichia's Vitasolis solves this problem. Another aspect is dynamization and personalization. The use of individually controllable and placeable floor lamps supports this requirement. This combination of features was enough to convince the jury.

For several years now, we have been reading about "the coming mega-trend" of integrating light in building structures. But except for some applications by Philips in reference projects, not much has happened in practice. Therefore, the jury was very pleased to award Glass Technology GmbH with their "LightGlass, the Fusion of Light & Glass" the "Best Lighting Design Award". The integration of LED lighting in window glasses requires special technical skills and manufacturing competence but opens new options. LightGlass as a product which is now available for any architect and project could change the current situation. This fact was the reason the jury appreciated the effort of Glass Technology GmbH in this field and expressed the hope that this example may encourage lighting manufacturers and lighting designers to let the dream of building integrated light become a reality.

### LpS&TiL Best Startup Certificate

This newly introduced certificate especially wants to honor the innovative power of small startups with limited capital. Based on similar objective criteria like the Awards, this first certificate goes to Luximprint & Physionary for "Additive Optics Design and Fabrication Technology". The enthusiastic commitment of both companies to improve and ease the

optical design process as well as looking for environmentally friendly solutions and processes, and thereby never forgetting the final requirement – which is providing adequate light for a given application – motivated the jury to assign this certification to the joint application.

### LpR Appreciation Certificate

For LED professional, as well as the industry in general, it is incredibly important to have supporters that advise, assist and believe in them in order to develop, grow and stay on the right path. The 75th jubilee issue of LpR was a great opportunity to honor six long-standing champions of our publication and event. A high-quality headlight, sponsored by Ledlenser, accompanied the certificate awarded to the following people:

Mr. J Norman Bardsley was honored for the time he has taken for many valuable discussions, his knowledgeable advice, and for always being prepared and willing to help us if we needed assistance. Prof. Mehmet Arik received the award for all the valuable contributions he has made to the magazine and for always being ready with advice when we were looking for a specific topic for the magazine. Carlos Lee from EPIC and Federico Galluzzi, Editor-in-Chief from Italian Lighting and Compolux were both honored for promoting and supporting LED professional as a whole: the magazine as well as the events. Marco de Visser, representing the small firm sector, and Patrick Durand, as CTO of a large distributor were honored as industry representatives for their innovative spirit and deep technical understanding that they have always been willing to share with LED professional making them incredible sources of ideas for new topics and articles.

Without people like these, neither the lighting industry nor LED professional would have become what they are today. The tribute to these six personalities, partners and, meanwhile, friends, also expresses the thought that only by cooperating and by joining forces can success be achieved

### On the Show Floor:

In addition to the award winning products, several interesting technologies and applications were showcased of which some directly or indirectly contribute to a positive effect on the environment, sustainability,

## IMPRESSIONS FROM LPS & TIL

► In celebration of the 75<sup>th</sup> LpR issue, six partners were honored with the LpR Appreciation Certificate. They also received Ledlenser's high-end MH11 LED headlamp.



◀ Group photo of the award winners and honored partners in the Eilguthalle in Lindau

or HCL. The range spreads from the new Zhaga compliant CoB holders to 3D printed luminaires, and from new LED modules to LED drivers. Some of the highlights, which are also part of our product showcase, will be briefly described below.

Bender + Wirth presented a new, modular CoB holder with improved properties in a clever modular design that allows fast and cost-effective individual adaptations for different CoBs and mounting options for secondary optics.

VADACTRO Technologies from India presented their SL-Bus platform that is based on Marvell's IoT technology - to be exact: Marvell 88MW300/302 Wi-Fi microcontroller. The company boasts a versatility that allows for the configuration of the respective program hardware to be used as communication module for any system, whether wireless or wired, DALI or DMX, DSI or KNX, Zigbee or Z-wave, Bluetooth or WiFi, just to name a few.

When it comes to drivers, Nordic Power Converters with their latest development, InviTrack, an "invisible" track driver, must be mentioned. In cooperation with Eutrac, they have redesigned their existing driver concept, which was already very small, to fit inside the track. The main challenge was the thermal design and properties. The system allows the design of smaller spot lights and eases thermal design of the spot light as it takes off the thermal load generated by the driver from the LED module.

Meanwhile, a "constant burner" with interesting new products is Bartenbach. This year they introduced the RMJ-Asymmetric, a 40 mm wall washer micro-faceted free-form reflector. While the optical light distribution properties are not new, what is new is to get them in such a tiny reflector in this degree of excellence. While mounted fully flush, it generates no disturbing shadows in the top section of the wall and it has a longitudinal cut-off parallel to the wall, a perfect incision and homogeneous light distribution. Even more surprising is the perfect color mixing capability of the tiny reflector, which is required for color tuning, tunable white or dim-to-warm solutions.

Two startups also caught our attention: One, a small, local startup, ÖkoLED, that combines SunLike technology with 100% all-natural organic material 3D printed

custom design. The other startup was Lightly, a company from Ireland. Their Hikari SQ ultra-thin LED modules compete with OLED modules but offer the known advantages of LEDs, better lifetime, higher luminance and better efficiency. The company strives to provide quality lighting and therefore high CRI of 93+ and a homogeneous light emission area are self-evident.

### Lessons Learned:

Light quality and sustainability were the dominating topics. System efficiency is still relevant but sustainability means more than just efficiency: Manufacturers and service providers are taking life cycle into account, responding to their responsible clients' requests. "Human Centric Lighting, not just for the moment but for the future!"

### Findings from Scientific Paper Award Submissions and the Conference Program

Today's biggest topic seems to be HCL. When looking at the LpS program, because we can assume that contributions to the TiL program will always be somehow related to HCL features, we can see that about 1/3 of the lectures include aspects of HCL. In addition, over 1/8 cover IoT and more than 1/10 cover environmental aspects. This makes a total of almost 60% of all LpS lectures.

Another interesting statistic in this regard delivers the analysis of the applications for the "Scientific Award". Forty percent of the formally accepted submissions also concerned HCL or environmental issues. Unfortunately, only one of those papers made it to the shortlist. Surprisingly, no papers were concerned with IoT and we have to ask ourselves, why? As interesting as it might be to ponder the reasons, let's take a closer look at some lectures from LpS and TiL, starting with the "Best Scientific Paper":

### Best Scientific Paper Award 2019

Out of six shortlisted valuable contributions, the paper "Micro-optics for Efficient LED Spotlights with Arbitrary Farfield Distributions", submitted by Peter Schreiber from the Fraunhofer Institute for Applied Optics and Precision Engineering IOF, made the race based on the evaluation of our scientific partners. The jury came to this

decision because Peter Schreiber describes a new approach using a micro-lens array as tertiary optics. He describes the current state of the art – a fly's eye condenser – and the innovation based on it – free form optics working as a kind of irregular fly's eye condenser. Based on this idea the team realized two demonstrators: a high beam and a low beam lens for automotive headlight. The paper depicts how the demonstrators were manufactured and shows measured results for both. The jury honors the innovative approach as well as the scientific work leading to applicable demonstrators. To learn more, please read the full paper in this issue on page 40.

### Selected Lectures at LpS and TiL

Two very exciting lectures opened the sessions "Standards Driving Business" and "Human Centric Lighting I" on the first day. Mag. Wilfried Pohl from Bartenbach, Austria, started with the controversial topic "Human Centric Lighting – Critical Opinion on the Current Status" and Deidre Wolff from IREC in Spain talked about "When Circular Economy Meets the Lighting Industry".

Ms. Wolff disclosed findings from the EU funded Repro-Light project starting with the assessment of conventional LED linear luminaires using Life Cycle Assessment (LCA) methodology, paying particular attention to both Climate Change and Resource Depletion impact categories. She concludes that the components of the LED luminaires which contribute the most to the environmental impact from production are the electronic components. Therefore, the design of modular LED modules and LED controls components with better material efficiency, such as optimizing the size of circuit boards and the quantity of circuit board components and LEDs can lead to reductions in the environmental impact from these components. Furthermore, she proposed looking at second life options in other applications for old LEDs once they have reached the end of their first life when the light output has decreased to 80% of the initial value, e.g. for emergency lighting. She also emphasized that recycling technologies are also improving to extract the elements from electronics products at the end of their useful life, which can help to further reduce the impact from resource depletion of non-renewable elements. Ms. Wolff also stated that LEDs have yet to



## IMPRESSIONS FROM LPS & TIL



▲ LEDs and sophisticated controls technology are also used for Gilda's dress for the unmissable opera production of Rigoletto on the lake stage at the Opera House, Bregenz

▼ A thin, flat luminary in the foyer also attracted interest and inspired discussions



reach their full potential in achieving even more energy savings in the use phase by appropriate measures.

Mag. Pohl addressed the problem that, today, we live alienated from natural daylight as we spend most of the day indoors, and the lighting standards only define minimum lighting levels for vision. On the other hand, due to bright room lighting with a daylight-like spectrum, computer and mobile displays for private use, and outdoor lighting applications many people get too much light in the natural dark phase. He also asked which non-visual effects are scientifically proven today and how well non-visual effects can be predicted. His conclusion is sobering: "The approach to establish a mathematical model to quantify health impacts (health metrics) of lighting is a keen endeavor." Even more disturbing was his answer to the question of whether we know enough to define general and mandatory recommendations and standards. By citing different specialists, he clearly showed that some apparently sound guidelines like the Circadian Lighting standard by UL are, in reality, not very useful. It's no wonder that CIE is very conservative in their recently published CIE S 026 / E: 2018 standard [24]) and does not make quantitative predictions about specific non-visual light effects. It merely describes the potentiality of the light stimulus to produce a variety of non-visual lighting effects. In short, he concludes that this topic remains a challenge.

The last session of the first TiL track on "New Lighting Design Approaches and Applications! was held by Ruairi O'Brien, lighting designer and professor at the GUC in Cairo, Egypt, titled "Inside the Pyramids - Light Where There Should Be Darkness". People who know him also know that he uses light very carefully and that he plays with light and shadow. In his lecture he emphasized that light needs darkness, especially in the context of architecture. He says that not everything that can be illuminated necessarily must be illuminated at night: "Heritage buildings are extremely difficult to light and thankfully the pyramids are, as yet, not lit at night so they can still master the dusk and the coming of darkness as they have done for thousands of years." However, the central part of his lecture concerned the interior space of the Great Pyramid and especially the core, the burial chamber. He asks: "How do we light such a space appropriately?" In this lecture,

Prof. O'Brien not only gave examples of how this monument could be illuminated but he went beyond that, or better said, took several important steps back: He invited the audience to find and ask themselves the right questions. Questions that need to be answered before starting such a project as only the right answers can lead to an ethically acceptable but pleasant and functionally optimized lighting design. In this regard, he went on to discuss the difficulty lighting designers face with important heritage buildings.

As diverse as these three lectures seem at first glance, one thing they have in common is that they are all asking for a diligent, responsible handling of subjects, resources, objects, and light.

Day two at LpS was filled with 72 equally interesting lectures as well as a lot going on in the expo. With a heavy heart, I had to accept that I would only have time for four lectures. While many of the TiL lectures are noteworthy, I'll only mention one here along with three technical lectures from LpS.

Prof. Claude Gronfier's lecture on "Light and Health: What are the mechanisms?" vividly demonstrated how complex the interaction between light and human physiology is. The scientist from Inserm in France explained that by focusing on melanopic illuminance alone, unjustifiably, leaves relevant, nuanced contributions of the other circadian functions ignored, and referred to the alpha-opic system. Certainly, melatonin suppression is mainly driven by ipRGCs, but this is not the whole story: Prof. Gronfier emphasized that it is also a matter of timing and intensity. And he added that while research is still required to figure out details, it has become obvious that inappropriate lighting, and misalignment of the clock, can lead to disorders and diseases (sleep, cognition, memory, metabolism, mood, cancer). Mr. Gronfier emphasized in his conclusion that light can also be used to avoid and treat disorders but inappropriate exposure (intensity, spectrum, timing) can have side effects and lead to disorders, even at small intensities/durations. He closed by saying that light hygiene is essential for health (solar light during the day, darkness at night)!

Also addressing HCL, the lecture on "Photobiomodulation: A New Dimension to HCL" by Martijn Dekker and Juergen

Honold from Seaborough extended the meaning of HCL. The lecturer discussed the same issue that Scott Zimmerman addressed in his article "in LpR 66 [3]: The relevance of near-infrared (NIR) light for human physiology. They explained that photobiomodulation is mainly used as a therapeutic medical method but the scientific knowledge gained implies that it could add value to general lighting by providing increased human wellbeing and maintenance of health. Without going into too much detail, their arguments can be summarized as follows: The mitochondrial system, our body's "power plant", benefits from NIR light that supports Cytochrome C Oxidase to resume the production of cell energy as ATP. Furthermore, it needs to be recognized that many processes in the body take place in the skin and that this is the place where near-IR makes an impact as it can even reach the subcutaneous layer. The supported processes in these tissues cause positive systemic effects for our body. As dosimetry is meanwhile well understood, they proposed an approach that adds NIR by only increasing the energy consumption of today's LED luminaires by 5%. They also cleared up the common misunderstanding that the IR light from incandescent lamps is beneficial. For example a 100W-bulb utilizes approx. 0,02 mW/cm<sup>2</sup> at the skin, which is a magnitude below the required dose to have any biological effect.

In his lecture "Micro-Optics for Efficient LED Spotlights with arbitrary Farfield Distributions", Dr. Christoph Wächter who stepped in for Dr. Schreiber, dove deep into science and technologies when he explained the details of this new approach. The Scientific Award winner disclosed a theoretically surprisingly simple variation of the Koehler Integrator, better known as Fly's eye condenser (IP from 1937), that allows virtually any light distribution with low losses in an extremely compact design. However, the devil is in the detail, which means in the production. But, as the ruling from the Scientific Award Paper judges has already been mentioned and the full paper on this topic is part of this LpR issue (see page 40) not much more shall be said except that you should keep the word "micro" in mind!

Dr. Hani Kanaan from Cea Leti in France broached a topic that is currently gaining massive momentum. The title of his lecture, "Towards New Generations of Lighting and Display: Micro-LEDs", already hints at the

# IMPRESSIONS FROM LPS & TiL

► Mag. Pohl addressed the problem that today we are alienated from natural daylight – "quod erat demonstrandum" with this picture

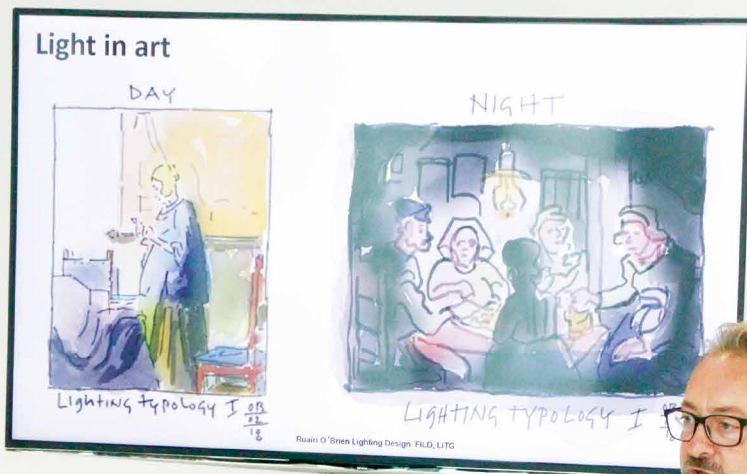
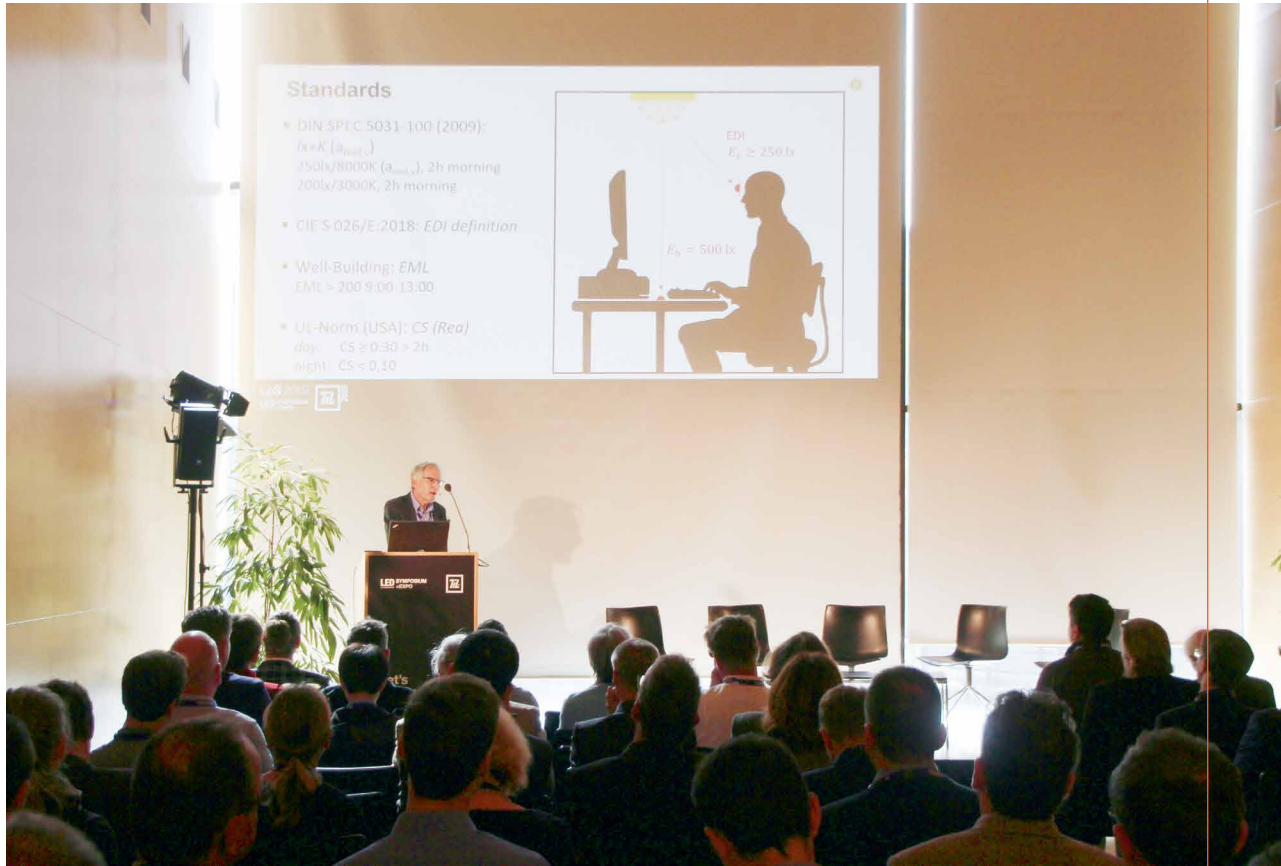

◄ The talk by Ruairi O'Brien in the TiL session showed his enthusiasm for his profession as a lighting designer

intended direction. While market reports forecast a huge increase in volume and market share for micro-LEDs, it would be better if we wait for what will be reality and stay with the facts of the technical challenges and solutions as Mr. Kanaan disclosed: Micro-displays need the integration of LEDs and transistors which could be hybridization or monolithic. The latter, for which proof of concept is also already done, has the advantage of allowing a very high pixel density, but several challenges remain. In a new concept, the researcher proposed an all-in-one RGB LEDs on CMOS solution that includes the driver. These "micro-modules" are then transferred to the final substrate; the chief remaining obstacle: A very high-speed transfer process with high accuracy must be developed for mass application. After a very thorough description of the processes and state-of-the-art of microLEDs technology, Mr. Kanaan also presented several application examples from automotive headlamps to adaptive street lights and - very promising - high data rate LiFi with spatial division and resource allocation. He concluded that MicroLED arrays in Automotive are becoming a reality and in LiFi great progress is ongoing and finally asked: What about lighting? LED professional will follow the topic and go into more detail in the Tech Talk Bregenz with Dr. Hani Kanaan to be published in LpR 79.

Day three was even more full than day two. Due to interviews and other duties I simply had no time to attend any lectures, although it would have been well worth it to attend both LpS and TiL on that day! The LpS topics: quality and testing, quality engineering and light in applications were filled with interesting lectures covering automatized lighting audit, evaluation of "blue light hazard", EU energy regulation and measurement, solders for CSPs, LED spectra for street lights, UV LEDs for disinfection or reducing jetlag with light, just to name a few. TiL featured digitalization, installation and commissioning, trends, and OLEDs. The lectures concerned topics such as truly wireless controls, tunable light, spectrum engineering for HCL, Bluetooth Mesh, and lightguides for OLEDs.

### Lessons Learned:

Just a few really new technologies were presented but the ones on stage were extremely interesting. It was remarkable that most highlights concerned miniaturization like the two selected examples that offer solutions to shrinking structures to the level of some  $\mu\text{m}$ . The dominant topics in both LpS and TiL were light quality and sustainability. Applications defined the content of the program: Human centric lighting and controls. Questions on health, well-being and handling were dominant.

### Findings from the Panel Discussions

Of the different panel discussions held at the show, one summarized the broad range of topics of all the other panels very well. Rogier van der Heide, who moderated The CEO Panel or CEO & Influencer Panel, that was manned by heads of industry and organizations. The panelists, Zumtobel's Alfred Felder, Nichia's Shinichi (Steve) Yuasa, Trilux's Klaus Röwekamp, Carlos Lee from EPIC, Ourania Georgoutsakou representing LightingEurope, and Jan Denneman for the Good Light Group, answered questions from the audience. The questions pertained to "the future of light in 2025", "what the most important thing would be to bring the lighting industry forward, e.g. inspiration from the outside, collaboration, ...", "customer expectations concerning light in 2025", "value creation" and "the value of smart lighting". The picture drawn by the panelists was surprisingly consistent. Without using direct quotes, the highlights can be summarized with a few keywords: Cooperation, light quality and HCL, sustainability, create value, think outside the box, tell the story!

### Lessons Learned:

Following the list of keywords step by step might be the best way to summarize the conclusions, starting with cooperation: In any respect, "together" is the only way possible to pave the way for a successful future for the industry and related service providers, from designers to planners and installers. This concerns research as well as pilot projects and strategies. Light quality and human centric lighting: Many things are already

known and proven but even more is unclear. Users need to be informed and educated about the benefits of good light. Sustainability: Already a part of the industry's agenda, there is still potential beyond efficiency that must be utilized. Creating value: On the one hand this brings us back to the topic of information and education but opens a new field, the voice of the customer - listen carefully to what the customer really values and wants. Thinking outside the box: Take inspirations from outside the lighting industry and be brave, accept calculated trial and error in pilot projects. Otherwise, creating new value remains an idle wish. Finally, tell the story: This is maybe the most important advice - it includes the aforementioned request to inform and educate. Only if this is done right, will people become aware of the importance of light in their lives and - hopefully - appreciate light and accept the necessary costs.

### Key Take-Away

An exhausting 2½ days, not being able to explore all facets of the diverse universe of lighting at LpS and TiL, nevertheless show a more positive picture of the whole industry as in previous years, especially compared to Light + Building 2018 where I asked myself "Lighting Industry Quo Vadis?" Today, the direction is much clearer. Priorities are HCL, user experience and sustainability, topics that are driven by the verdict of the public. IoT and soon AI are important vehicles that support these priorities. This does not mean that it's all easy going and that there are no hurdles to overcome. There is still a lot to do - a long way to go. But the answers of how to manage this are on the table, demonstrated in lectures and workshops and perfectly summarized by the panelist of the CEO (& Influencer) Panel. Most importantly: Tell the story!

LpS and TiL have once again proven to be the platform and industry meeting point in Europe that tells the story within the lighting community and creates the story to be told outside the industry to the customer, and the public. I am excited to see what happens and to listen to the story of the community at the 10<sup>th</sup> LpS and 3<sup>rd</sup> TiL in 2020! ■

### References

- [1] LpR 55 – May/June 2016 issue, page 36: Light + Building Post Show Report - The Six Most Noteworthy Observations, by Arno Grabher-Meyer, Luger Research/LED professional
- [2] LpR 57 – Sept/Oct 2016 issue, page 68: Technologies for Engineering an LED Light Closest to Sunlight, by Masahiko Yamakawa, Toshiba Materials
- [3] LpR 66 – March/April 2018 issue, page 62: A Near Infrared Enhanced LED Lighting Approach, by Scott Zimmerman, Silas

## IMPRESSIONS FROM LPS & TIL

► The panelists of the "Woman in Lighting" panel discussion in the Park Studio enjoyed themselves



◀ The 2019 press conference was completely dedicated to organizations and their work. From left to right: Sarah Toward, moderator, Jan Denneman for The Good Light Group, Ourania Georgoutsakou for LightingEurope, Heinz Seyringer for V-Research and Photonics Austria, and Dee Denteneer representing Zhaga



## IMPRESSIONS FROM LPS & TIL

► ESCATEC, as the manufacturing and development partner from Osram, presented the brand new CHRONOGY EYEWEAR at their booth which, they claim, helps to activate or relax and reduce jetlag

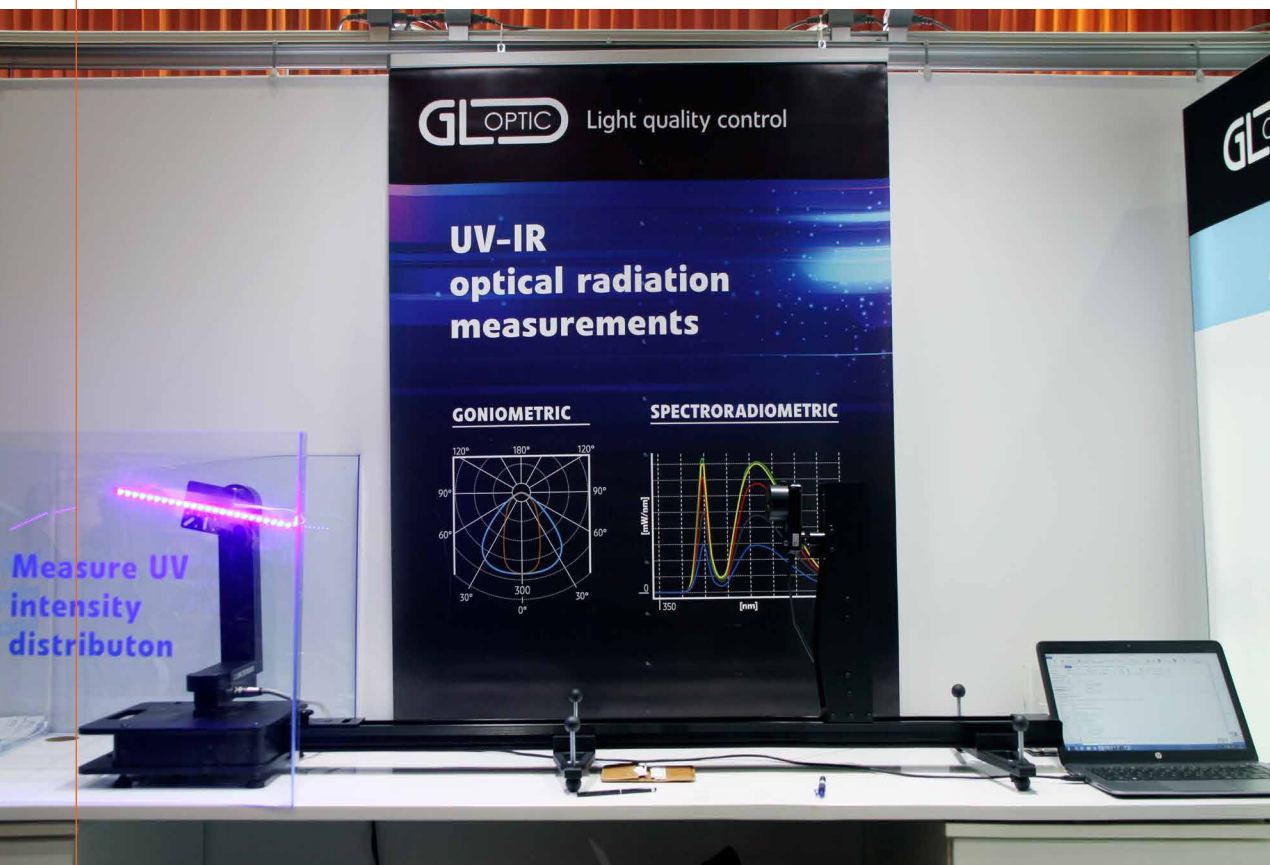

◀ GL Optic's GL RID one UV measurement system was awarded the LpS Application Award 2019

## IMPRESSIONS FROM LPS & TIL

▼ 10 years of research allow Lumitronix to utilize plasma metallization and paper to manufacture PCBs which enable completely new applications for lighting designers and architects



▲ Startup company, Lightly's flat OLED-like LED modules attracted a lot of attention. As a demonstration object they brought a module with them that was designed as an E27-lamp

## IMPRESSIONS FROM LPS & TIL

► The keenness for gathering information at the Lunatone booth shows how important controls have become in the LED lighting business



◀ Nordic Power's application for an LpS Technology Award, InviTrack - The Invisible Track Driver: This driver completely hides in the track and the spotlight can be more compact and doesn't have to dissipate the heat from the driver anymore



## IMPRESSIONS FROM LPS & TIL

► Covestro presented improved materials for diffusers with higher transmission capabilities while maintaining the diffusion and manufacturing properties of their predecessors

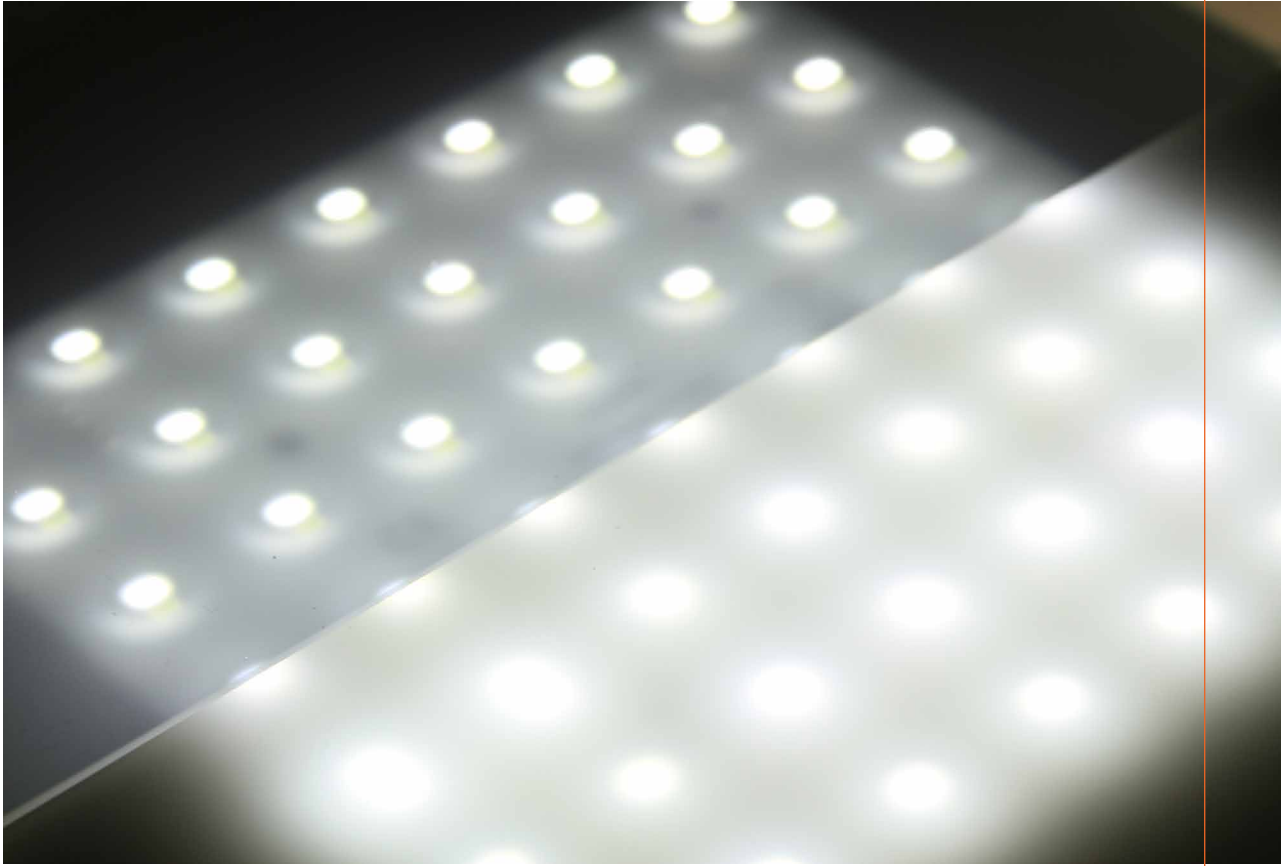

◄ Bender + Wirth had just introduced their new CoB holders (front) shortly before the LpS. The modular design allows easy individual configuration for lighting manufacturers offering similar unmatched thermal properties like the original CoB holders (behind)

## IMPRESSIONS FROM LPS & TIL

► Glass Technology's award winning Light Glass (left: switched off; right: switched on) brings the lighting industry and lighting designers one step closer to the vision of full building integration. BTW, it's color tunable as you can see on the second smaller window



◄ Biodegradable 3D printed luminaries from an innovative Austrian company, EcoLED, also attracted visitors



# LpS 2020

**LED** SYMPOSIUM  
professional +EXPO

**10<sup>th</sup> International  
Lighting Event**

[www.LpS2020.com](http://www.LpS2020.com)

Let`s  
experience  
the future  
of light.

**September  
22–24, 2020**

Opera House  
Bregenz

**Call for  
Speakers**

Europe's Foremost Lighting  
Conference and Exhibition

Deadline  
Feb 15, 2020

# A White Light Tuning Strategy that Fuels HCL

Human Centric Lighting (HCL) is projected to offer significant growth opportunities for manufacturers in the next few years. Dynamic white light spectrum tuning is a key technology to HCL. Wouter Soer, Director, Illumination Product Development at Lumileds, uses Luxeon Fusion to explain how LED optimization and open-loop control enable dynamic, user-friendly tuning solutions.

Dynamic tuning of the white light spectrum is an indispensable tool for lighting designers striving to improve user experiences and add value in lighting applications. Human centric lighting - adjusting light to enhance human health and comfort - is rapidly gaining popularity. It builds on the more established use of correlated color temperature (CCT) tuning, which provides flexibility in the use of commercial spaces. One popular form of CCT tuning with LEDs is dim-to-warm behavior, which transitions to warm white light like incandescent and halogen sources. In addition to these types of color tuning that track the blackbody locus, the ability to tune to color points off the blackbody locus using LEDs, enables additional benefits such as creating a preferred white tint or a desired color rendition. While specific requirements vary, tunable white lighting applications generally require one or more of these capabilities to be implemented with the highest possible performance and minimal system complexity.

The key system requirements for an LED solution to address these applications are:

- Maximum flux and efficacy across a wide CCT tuning range, on and off the blackbody locus
- High color quality that supports the needs of professional and human centric lighting applications
- Ease of implementation (i.e. no factory fixture calibration) with precise color control over all operating conditions and over lifetime

The new approach was designed from the ground up to meet these system requirements. This article explores the technology supporting each of these aspects.

## Design for Performance

### Optimizing LED utilization

A key specification of all lighting products is the maximum light output, or luminous flux. In CCT tunable lighting products, this specification becomes a function of CCT. For example, a fixture with dim-to-warm functionality may have a reduced flux specification at the dimmed CCT setting (e.g. 1800 K) that gradually increases to full flux at nominal CCT (e.g. 3000 K). Another example is a human centric lighting design that may feature an increase of flux with CCT over a functional CCT tuning range ( e.g. 2700-6500 K) to enhance circadian stimulation or a subjective preference for light levels that increase with CCT [1]. In general, most application requirements are optimally addressed by a light source that can provide constant high flux over a functional CCT range of 2700-6500 K, while allowing CCTs in an extended range down to 1800K to be reached at lower flux.

Conventional CCT tuning systems that employ linear CCT tuning between two standard white LED color channels, or primaries, do not realize this desired flux profile. These systems typically achieve high flux in the middle of the tuning range where both primaries are fully on, but fall off steeply towards the endpoints where one primary is on.

Adding a third primary can help track closer to the blackbody locus but does not improve the flux profile. LED utilization is poor because only a fraction of LEDs contribute to total light output at either endpoint of the tuning range. In order to still achieve the flux specification at these endpoints, LEDs may be added, increasing system cost and – in the case of directional lighting – enlarging the source size which degrades beam control. Larger sources can also increase fixture size, which is typically a downside for fixture manufacturers.

Alternatively, LEDs may be driven harder to reach the desired flux, but efficacy is reduced due to droop. In either case, performance is compromised significantly by the poor LED utilization.

This problem is solved by realizing high LED utilization throughout the functional CCT tuning range of 2700-6500 K. By using three phosphor-converted (pc) LED primaries with optimized red, green and blue color points (Figure 1) that are significantly outside the desired tuning range at either endpoint, all primaries contribute significantly to the light output. Figure 2 shows the normalized flux for a given LED count at nominal current as a function of CCT. A linear CCT tuning system based on equivalent 2700 K and 6500 K 90 CRI LEDs is shown for comparison. The system achieves ~40% higher constant flux over the 2700-6500 K range due to the improved LED utilization.

Another advantage of the optimized primaries being spread far apart in color space is that they enclose a wide color gamut with white tuning options both on and off the blackbody locus. Figure 3 shows the color gamut covered in the CCT/Duv color space. The gamut includes the blackbody locus (with Duv=0) from ~2200 K to >10,000 K, and an infinite number of other options. Various studies have suggested a general preference for warm white chromaticity slightly below the blackbody locus [2,3], with Duv

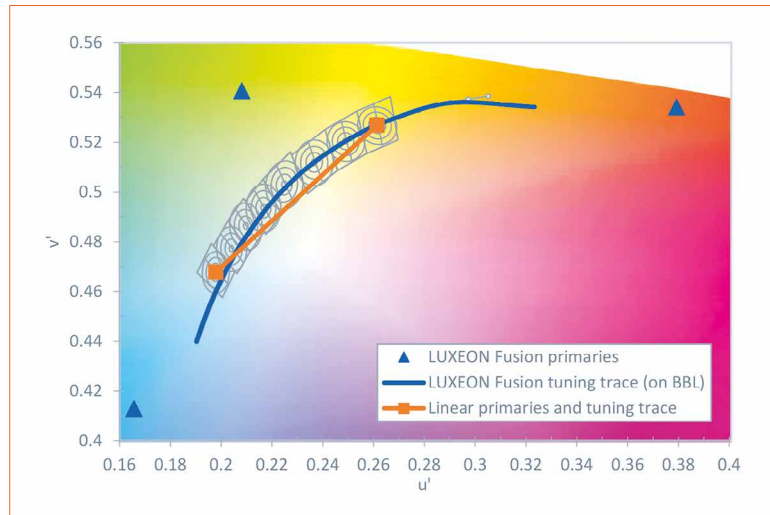

**Figure 1:** Relative to a linear system with 2700 K and 6500 K, 90CRI LEDs, the new system provides superior tuning from 1800 K to 10000 K along the blackbody locus in CIE1976 color space

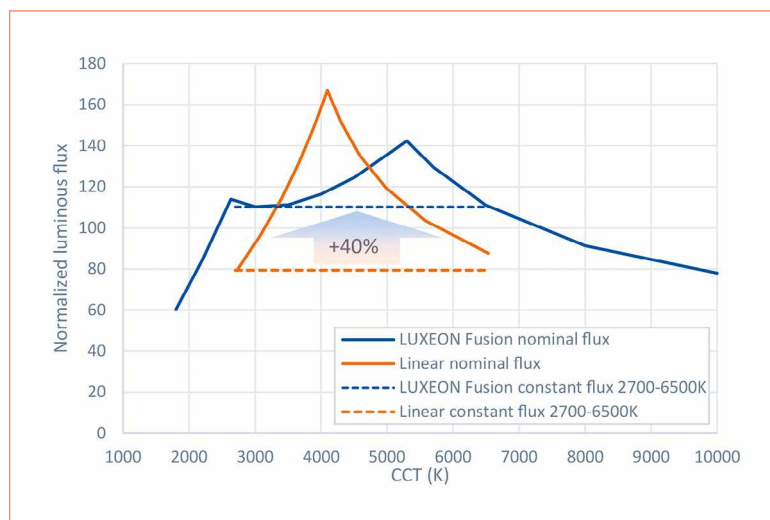

**Figure 2:** Luminous flux comparison between the new technology (tracing the blackbody locus) and a linear tuning system with 2700 K and 6500 K 90CRI primaries

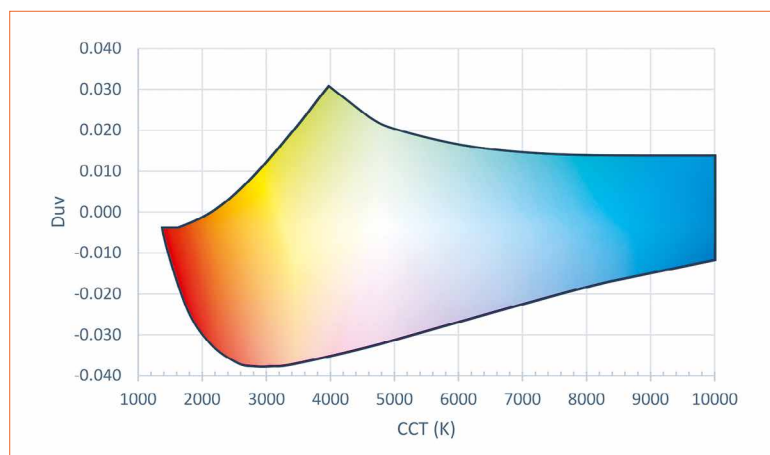

**Figure 3:** Color gamut in the CCT/Duv color space. The chart is truncated at a CCT of 10,000 K for better visibility, but the gamut extends well beyond 10,000 K

between -0.010 and -0.003, which can be easily realized down to 1800 K. Also, the daylight locus, which is offset from the blackbody locus by a Duv of about +0.003, can be reproduced. Chromaticity values much further from the blackbody locus are also possible if a more pronounced offset is desired.

**Spectral modeling**

The LED primaries were designed by an optimization process involving spectral modeling and tristimulus color targeting. Proprietary pc-LED modeling tools obtain an accurate representation of the flux and spectrum of each LED primary as a function of color point. The models take into account the optical characteristics of the phosphor

materials, including excitation and emission spectrum and scattering properties, as well as the package efficiency of the LED device architecture. The key result is a color space map of the flux that can be obtained in each LED primary using both commercially available phosphors and in-house-developed phosphors, while satisfying color quality requirements.

In the next step, we generated composite white flux vs. CCT profiles in order to optimize the color points of the primaries within this color space. The flux at any CCT for a given set of primaries can be calculated by color targeting in the CIE1931 XYZ color space. This color space encompasses all visible colors expressed in the tristimulus values X, Y and Z, which can be calculated for any spectral power distribution (SPD) using the corresponding color matching functions  $\bar{x}(\lambda)$ ,  $\bar{y}(\lambda)$  and  $\bar{z}(\lambda)$ . Since  $\bar{y}(\lambda)$  equals the photopic luminous efficiency function,  $V(\lambda)$ , the Y value represents luminous flux when the SPDs are expressed in spectral radiant flux (W/nm).

A convenient property of the CIE1931 XYZ color space is that it is linearly additive, meaning that the tristimulus values of a combination of multiple light sources can be calculated by separately adding the X, Y and Z tristimulus values of the individual light sources. With three primaries, this can be expressed in matrix notation.

Conversely, the bias on needed on each primary (Xn, Yn, Zn) to reach a desired total tristimulus (Xt, Yt, Zt) can be computed by a simple matrix inversion. - See tristimulus calculation matrix (EQ1) and the matrix inversion (EQ2).

We used this direct calculation method to evaluate flux vs. CCT profiles of thousands of combinations of hypothetical primaries in an iterative process to optimize the color points of the primaries.

**Separation of phosphors**

By design, the optimization process leads to a red, green and blue color point with a particular benefit: separation of green and red phosphors. In the optimized system, the red LED contains a relatively high loading of red phosphor with virtually no green phosphor, the green LED contains a high loading of green phosphor with virtually no red, and the blue LED contains a much lower phosphor loading with similar amounts of red and green phosphor. Conventional white LEDs have substantial loading of both green and red phosphor in the same package, which leads to re-absorption of down-converted green light by the red phosphor since the red phosphor has an excitation spectrum that extends well into the green.

In other words, a large part of the red spectrum is down-converted twice – first to green and then to red – compounding the efficiency losses of both phosphors. Separating green and red phosphors over different LED packages eliminates this reabsorption and enables a significant efficacy gain compared to standard white LED solutions at the same drive conditions. The efficiency gain is especially significant relative for warm and neutral white LEDs that have substantial red spectral content.

Figure 4 shows the efficacy of the new approach as a function of CCT compared to a linear tuning solution with state-of-the-art equivalent 90 CRI white LEDs. The significantly higher efficacy is observed largely due to the phosphor separation. Another contributing factor is that the new approach allows precise tracking of the blackbody locus, while the linear tuning solution dips significantly below the blackbody locus in the neutral white CCT range. At these CCTs, the Luminous Efficacy of Radiation (LER) of the spectrum increases significantly with Duv, leading to an intrinsic efficacy penalty for color points below the blackbody locus. This penalty is avoided with this new technology. The comparison in Figure 4 is made at the same drive condition, meaning the new solution has higher flux for a given LED count. Comparison at the same flux per LED count would further enhance this efficacy advantage

Tristimulus calculation matrix:

$$c_1 \begin{bmatrix} X_1 \\ Y_1 \\ Z_1 \end{bmatrix} + c_2 \begin{bmatrix} X_2 \\ Y_2 \\ Z_2 \end{bmatrix} + c_3 \begin{bmatrix} X_3 \\ Y_3 \\ Z_3 \end{bmatrix} = \begin{bmatrix} X_1 & X_2 & X_3 \\ Y_1 & Y_2 & Y_3 \\ Z_1 & Z_2 & Z_3 \end{bmatrix} \begin{bmatrix} c_1 \\ c_2 \\ c_3 \end{bmatrix} = \begin{bmatrix} X_t \\ Y_t \\ Z_t \end{bmatrix} \quad (EQ1)$$

Matrix inversion:

$$\begin{bmatrix} c_1 \\ c_2 \\ c_3 \end{bmatrix} = \begin{bmatrix} X_1 & X_2 & X_3 \\ Y_1 & Y_2 & Y_3 \\ Z_1 & Z_2 & Z_3 \end{bmatrix}^{-1} \begin{bmatrix} X_t \\ Y_t \\ Z_t \end{bmatrix} \quad (EQ2)$$

due to the higher drive current needed in the linear solution. The higher efficacy of the linear solution near 6500 K is due to the center of the ANSI bin being above the blackbody locus; setting the new system to this color point would yield similar efficacy.

### Design for Color Quality: Color Rendering and Saturation

A key design objective for the new approach was to achieve high color fidelity with CRI Ra>90 and R9>50 across the functional CCT range of 2700-6500 K, while maintaining CRI Ra>80 over the warm dimming range down to 1800 K. We performed spectral modeling described with these boundary conditions, leading to broadband primaries that can produce a continuous spectrum across the CCT range. As in white pc-LEDs, an essential element for maintaining high efficacy is the integration of narrow red down-converters. The in-house developed SLA (SrSiAlN<sub>3</sub>) narrow red phosphor [4] maximizes the LER of the red primary and the composite white light. SLA provides an optimal combination of red color rendering and efficacy including robust performance under mid power and high-power LED operating conditions with a narrow peak centered around 650 nm. Figure 5 shows the CRI performance as a function of CCT.

Color saturation is an important aspect in applications such as retail lighting, where saturated colors can enhance desired attributes in merchandise. For instance, high color saturation in meat products can emphasize the freshness and appeal of the product. High color fidelity sources inherently produce near-full-color saturation; however, we can enhance saturation by tuning to a color point below the blackbody locus. ANSI/IES TM-30-18 [5] provides a good overall measure of saturation through the Rg gamut index, and of saturation of individual hues through

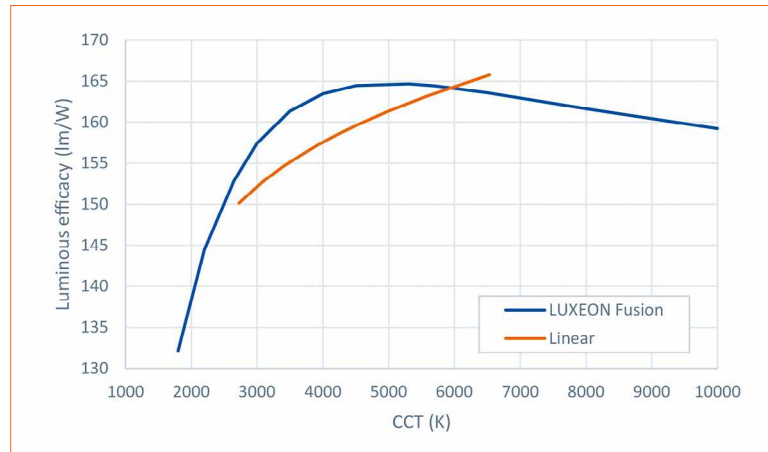

**Figure 4:** The new system achieves higher efficacy due to phosphor separation and tracking along the blackbody locus

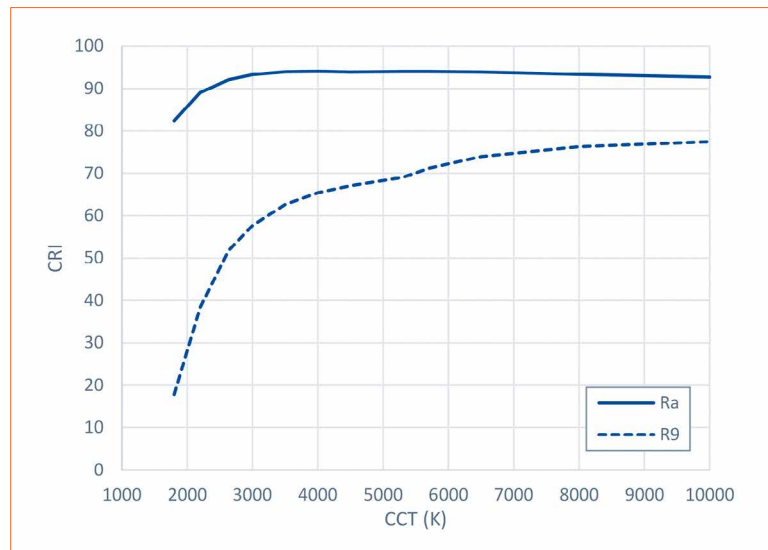

**Figure 5:** Color rendering values Ra and R9 as a function of CCT (tracing the blackbody locus)

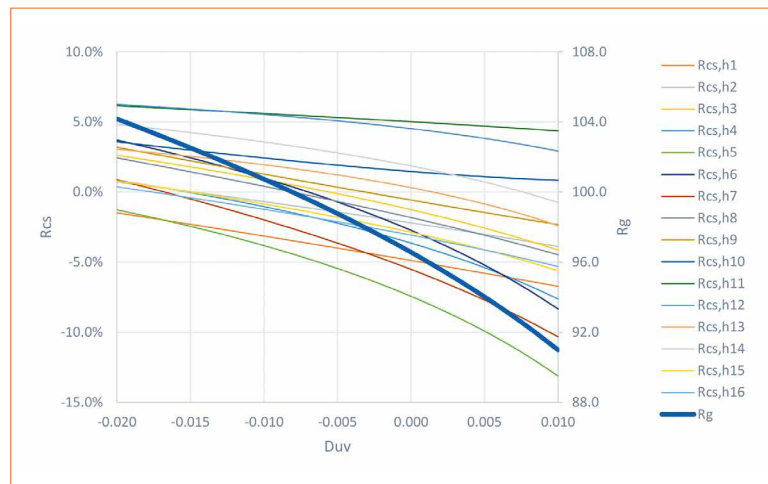

**Figure 6:** TM-30-18, chroma shift indices (Rcs) and gamut index (Rg), for a Fusion system at 3500 K as a function of Duv. By setting the color point below the blackbody locus (negative Duv) the color saturation can be significantly increased

the chroma shift indices, Rcs. Studies have shown that subjective preference correlates well with saturation, once a basic fidelity threshold is met [6]. As illustrated in figure 6, both these indices increase as the color point moves below the blackbody locus (Figure 5). This effect can be used in applications to define optimal color points based on tint and color saturation preferences.

### Human centric lighting

Tunable lighting systems may support user health and comfort by allowing lighting conditions to change throughout the day for an optimal balance of visual and non-visual functions of light. Non-visual physiological effects of light include secretion of melatonin and other hormones that play an important role in circadian

**Figure 7:** Melanopic to photopic ratio (tracing the blackbody locus) as a function of CCT. The new technology closely reproduces the melanopic content of daylight (CIE D series) at cool-white color temperatures while enabling lower melanopic content at warm-white color temperatures



entrainment. These effects are mediated by a photoreceptor called the intrinsically photosensitive retinal ganglion cell (ipRGC) [7,8]. The spectral sensitivity of this photoreceptor [9] is established in CIE S 026:2018. Light quantities weighted by this sensitivity are referred to as "melanopic" (e.g. melanopic illuminance, melanopic flux).

Human centric lighting designs often specify high melanopic illuminance early in the day and low melanopic illuminance later in the day to promote circadian entrainment [10]. The newly developed technology enables such designs by featuring a continuous spectrum in the blue-cyan range that provides high melanopic content at high CCT, similar to natural daylight, while enabling low melanopic content at low CCT (Figure 7). By combining this effect with the high flux capability described previously, it provides a dynamic range of melanopic flux that is

superior to linear CCT tuning solutions, including those with "full spectrum" white LEDs, on a per LED basis.

### Design for Integration

A primary concern with any color tunable system is color control. In the broadest sense, this means that the color point is stable over the full operating range and over lifetime and is consistent between systems within a specified tolerance.

The new product has been designed to operate under open-loop control, meaning no color feedback is needed to maintain the desired color point. This approach simplifies the tuning system architecture and reduces cost compared to designs with a color sensor. Open-loop color control is enabled by two factors. First, all primaries are based on the same phosphor-converted device architecture, meaning that they generally show similar behavior vs.

drive conditions and lifetime. Second, accurate LED performance data as a function of operating conditions is available through proprietary LED models calibrated with production test data. Thus, LED performance is reliably predicted at any point within the operating window, not just at the nominal test condition.

Conventional white LEDs may exhibit color shift over temperature and drive current due to photothermal quenching of the phosphors [11]. The new approach uses phosphor materials similar to white LEDs and thus is subject to similar color shift. However, since the performance of the primaries at any drive condition is known, these new systems can compensate for such shifts and achieve color stability superior to white LEDs.

A basic operating schematic is shown in Figure 8. A microcontroller takes the desired flux and color point (e.g. in CCT, Duv coordinates) as input parameters and outputs the drive conditions (e.g. drive current and PWM duty cycle) for each channel to achieve those parameters. In integrated designs, the controller may also perform driver functions. To determine the correct drive conditions, the controller is programmed to contain performance parameters of each LED installed in the system.

The starting point for achieving open-loop color control is to minimize variation of the aggregate performance in each primary channel (Figure 7). This is done by binning the primary LEDs and

**Figure 8:** This strategy of open-loop control enables accurate color and flux control at all operating conditions

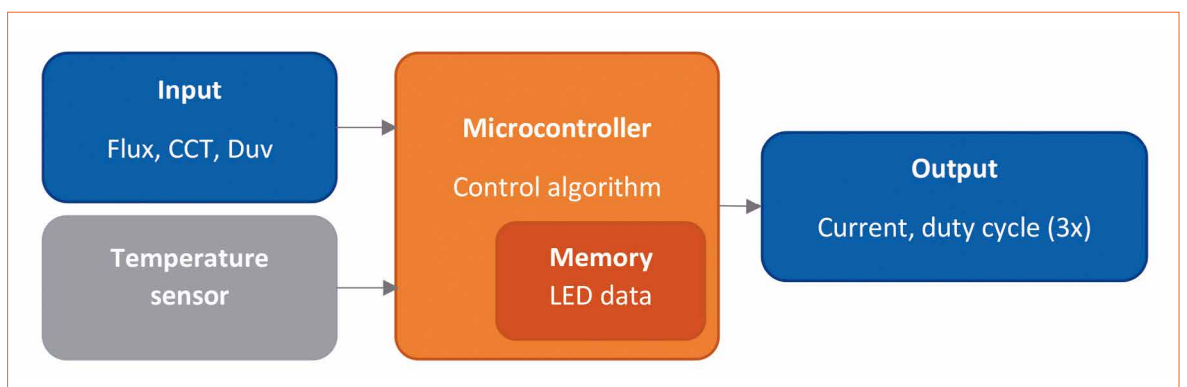



pick-and-placing LEDs from appropriate bins onto a module to achieve narrow distribution of the aggregate performance. A proprietary "Oberon" pick-and-place system is used to maximize module-to-module consistency by mixing LEDs based on performance data, enabling tighter distributions and eliminating the need for binning. As a result, this enables the assembly of modules where the aggregate performance of each primary is well defined over the operating range and has minimal spread. The LED performance parameters are then written into a flash or EEPROM type memory inline during module assembly.

Another important aspect of integration is the driver topology. In order to achieve the high flux and

efficacy performance, the driver needs to support the associated utilization of each channel over the functional CCT range. Single-channel drivers with a controller that time slices the input current over the three primaries are relatively simple to implement, but have the limitation that the sum of the duty cycles cannot be more than 100 percent. This significantly reduces the available system flux. On the other hand, multi-channel drivers offer the flexibility to define the duty cycle of each channel independently from 0-100 percent, but carry a significant component count and system cost. A proprietary driving scheme supports the LED utilization required to achieve full flux performance with the simplicity of a single-channel driver.

## Conclusions

Hospitality, healthcare, education and other markets are keen to integrate white light tuning based on human centric lighting's potential to maximize productivity and health. A new approach enables the next generation of tunable white solutions, combining real-time control with the highest quality of light and desired flux. The new sophisticated technology is available in a variety of packages to address non-directional and semi-directional applications such as linear fixtures and downlights as well as directional applications such as spotlights and track lights. A wide range of custom configurations is available, offering optimal system level performance through embedded LED data and optimized driver and control technology. ■

## References:

- [1] [1] R.G. Davis, D.N. Ginthner, Correlated Color Temperature, Illuminance Level, and the Kruithof Curve, *J. Illum. Eng. Soc.* 19 (1990), 27-38
- [2] Y. Ohno, M. Fein, CIE/USA-CNC/CIE Biennial Joint Meeting, Davis, CA, November 2013
- [3] J.P. Freyssinier, M.S. Rea, Class A Color Designation for Light Sources Used in General Illumination, *J. Light & Vis. Env.* 37 (2013), 46-50
- [4] P. Pust, V. Weiler, C. Hecht, A. Tucks, A. S. Wochnik, A.-K. Henss, D. Wiechert, C. Scheu, P. J. Schmidt, and W. Schnick, Narrow-band red-emitting Sr[LiAl<sub>3</sub>N<sub>4</sub>]:Eu<sup>2+</sup> as a next-generation LED-phosphor material, *Nat. Mater.* 13 (2014), 891-896
- [5] A. David, P. Fini, K.W. Houser, Y. Ohno, M.P. Royer, K.A.G. Smet, M. Wei, L. Whitehead, Development of the IES method for evaluating the color rendition of light sources, *Opt. Express* 23 (2015), 15888-15906
- [6] M. Royer, A. Wilkerson, M. Wei, Human perceptions of colour rendition at different chromaticities, *Light. Res. Technol.* 50 (2018), 965-994
- [7] G. Brainard, J.P. Hanifin, J.M. Greeson, B. Byrne, G. Glickman, E. Gerner, M.D. Rollag, Action spectrum for melatonin regulation in humans: evidence for a novel circadian photoreceptor, *J. Neurosci.* 21 (2001), 6405-6412
- [8] K. Thapan, J. Arendt, D.J. Skene, An action spectrum for melatonin suppression: evidence for a novel non-rod, non-cone photoreceptor system in humans, *J. Physiol.* 535 (2001), 261-267
- [9] R.J. Lucas, S.N. Peirson, D.M. Berson, T.M. Brown, H.M. Cooper, C.A. Czeisler, M.G. Figueiro, P.D. Gamlin, S.W. Lockley, J.B. O'Hagan, L.L.A. Price, I. Provencio, D.J. Skene, G.C. Brainard, Measuring and using light in the melanopsin age, *Trends Neurosci.* 37 (2014), 1-9
- [10] WELL Building Standard v2, <https://dev-wellv2.wellcertified.com/>
- [11] O.B. Shchekin, P.J. Schmidt, F. Jin, N. Lawrence, K.J. Vampola, H. Bechtel, D.R. Chamberlin, R. Mueller-Mach, G.O. Mueller, Excitation dependent quenching of luminescence in LED phosphors, *Phys. Status Solidi RRL* 10 (2016), 310

# A New LED Controller Technology to Expedite the Next Level of Smart Lighting

Lighting installations that use artificial lighting and are often deemed more comfortable and energy efficient are generally referred to as "Smart Lighting". While no clear definition exists "Smart Lighting" has become a common catch phrase. Kurt Marquardt, Senior Director LED Lighting Systems and Product Marketing, **Infineon Technologies** has a more accurate definition. For him, the term "smart lighting" describes the capability of the lighting system to adapt automatically to the needs of the users and the room. He presents an alternative way to implement smart lighting systems, using the new XDPL8221 digital LED-driver IC [1].

**Figure 1:** Schematic of the driver application and the inclusion of the UART for control and analysis

Many lighting installations are conceived to make the use of artificial lighting more comfortable and energy efficient. Usually, systems with such features are referred to as "Smart Lighting". This buzzword is used to promote a variety of features: starting from simply connected luminaires -

potentially with smartphone control - up to a fully connected lighting installation with sensors and devices controlled through a cloud application. However, a common denominator of all definitions is the demand for communication and information, but there is more that can be expected from "Smart Lighting".

Addressing smart-lighting features and customer requirements can add significant cost to lighting installations. Extra costs are caused by additional sensor components and the need for microcontrollers with numerous ADC channels. A microcontroller may also be required to control multiple operating parameters, including controlling LED-array brightness and dimming level. Sometimes the microcontroller's influence on the system/driver control may cause unwanted instabilities within the system. This is seen as variation of brightness, usually called flicker, and non-linearity of the brightness control, and luminaires that turn dark due to software bugs.

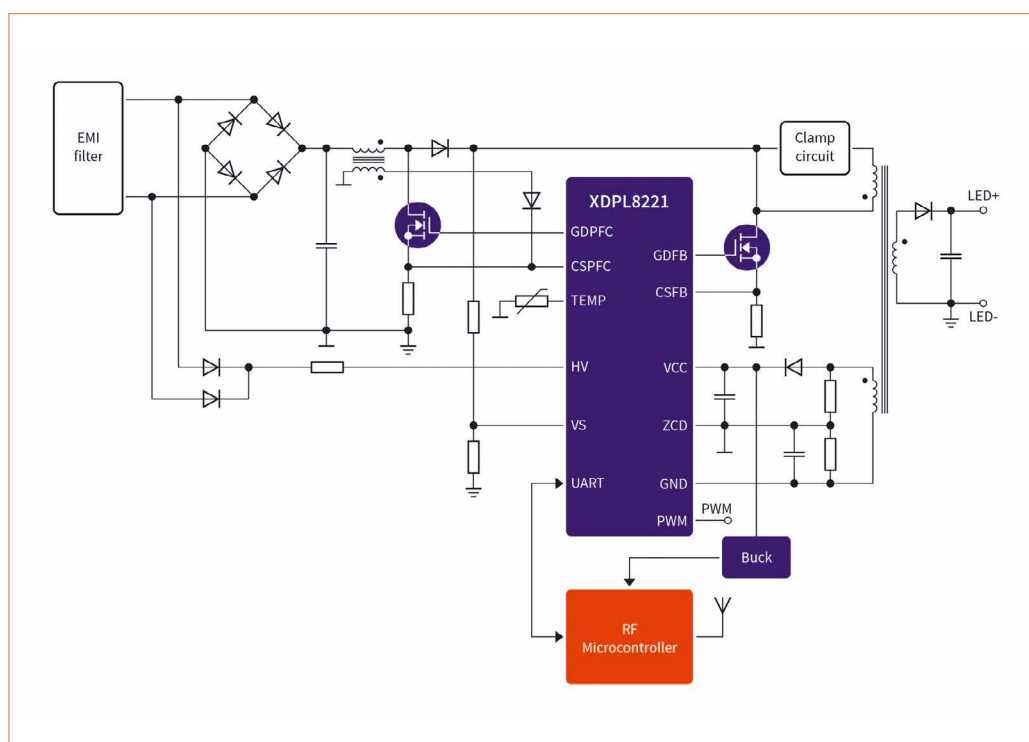

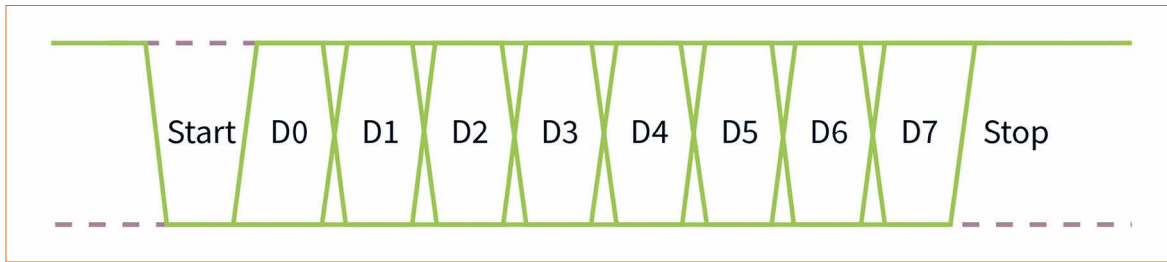

**Figure 2:**  
Principle waveform of the UART and basic concept of a byte frame

### A UART as Key Element for "Smart Lighting"

The distinctive 'universal asynchronous receiver transmitter' (UART) serial communication interface offers a new measure for control and analysis. The UART communication can control the power conversion in an AC/DC converter as a typical mixed-signal controller, with the added benefits of updates, communication, and storing the data of the converters health and operating conditions. System issues and failures like output over- or under-voltage can be instantly tracked through the UART monitoring functions. It permits to keep an eye on the device functioning or activated protections, bringing the considerable benefit of accurately determining the nature and location of any deficiency. This eases then the issue analysis process and permits to save costs and time by supporting a technician to identify the failing device, fix it instantly and efficiently thanks to the information read through the UART interface. In short, maintenance personnel can be purposefully sent to the right place with the needed replacement parts to fix the failing device. This saves significant cost as the maintenance personnel does not need to browse through the buildings to find failed devices and fetch the spare part from stock until repair can start.

Additionally, real-time measurement data are available via the UART. Operating data, like output voltage and output current, can be read at any moment. The constant availability of these values permits, for example, to determine the actual output power, and therefore gives insight into detailed information about the device's power

consumption, and manage it. Moreover, regular monitoring of LED current/voltage provides insight into the device aging. This allows the user to analyze the healthiness of the device and therefore permits the planning of maintenance. With this predictive maintenance, only necessary activities produce cost and downtimes are minimized. Considering a large building equipped with LED luminaires, the existence of a UART in each of these luminaires makes it possible to access the real-time data in every LED array. Any device showing deviations from 'normal' could be precisely detected, and therefore easily replaced before final failure.

### UART Commands and Basic Functionality

The UART's SET commands can influence many operating modes. For instance, the SET command configures the behavior of power conversion in multiple ways, i.e., determining the value for the maximum output defines the maximum brightness of the LED. Additionally, the SET command, which sets the dimming level, determines the final brightness. The numeric values of the parameters in the SET command eliminate uncertainty in recognition of an analog or PWM input signal. In PWM, for example, imprecise data results from the sampling of the input signal for measurement. During the input sampling and quantization, for the high and low times, the precision of the calculated duty cycle depends on the sampling frequency, the threshold for the input stage, or the slope of the input signal. Inaccuracies of both high- and low-time measurements add up to the uncertainties of the duty-cycle value. Higher sampling

frequency would reduce the error at the price of higher energy consumption and additional noise. Whereas the UART provides exact numerical values without any inaccuracies.

### Multi-Control Operation: One Hardware Design for Various Drivers

Another highlight is the multi-control operation, with the automatic selection of constant current (CC), constant voltage (CV), and limited power (LP). This facilitates its use for a wide variety of LED-driver products, based on the same hardware design. The mode is selected in accordance with the operating situations such as load and configuration. The LP mode is a special feature and allows utilizing the limits of the hardware to the full extent without jeopardizing safe operation. During LP mode, the device controls current and voltage in a way that the output power never exceeds the defined value. An additional advantage of this mode is the safe operation of cold LEDs, for example, in outdoor luminaires. In fact, the LED forward voltage and temperature are inversely proportional. This constitutes a problem in conventional constant current controls, which might run into overvoltage protection before any current flows through the LEDs. The result of this behavior might be that illumination will not start up from low temperatures. On the contrary, the new driver concept guarantees that it will at least drive current until the maximum output voltage is reached, which can be much higher than usual as the maximum power is also taken into account if some current reduction is doubted.

**Figure 3:**  
Safe operation area and protection functionality

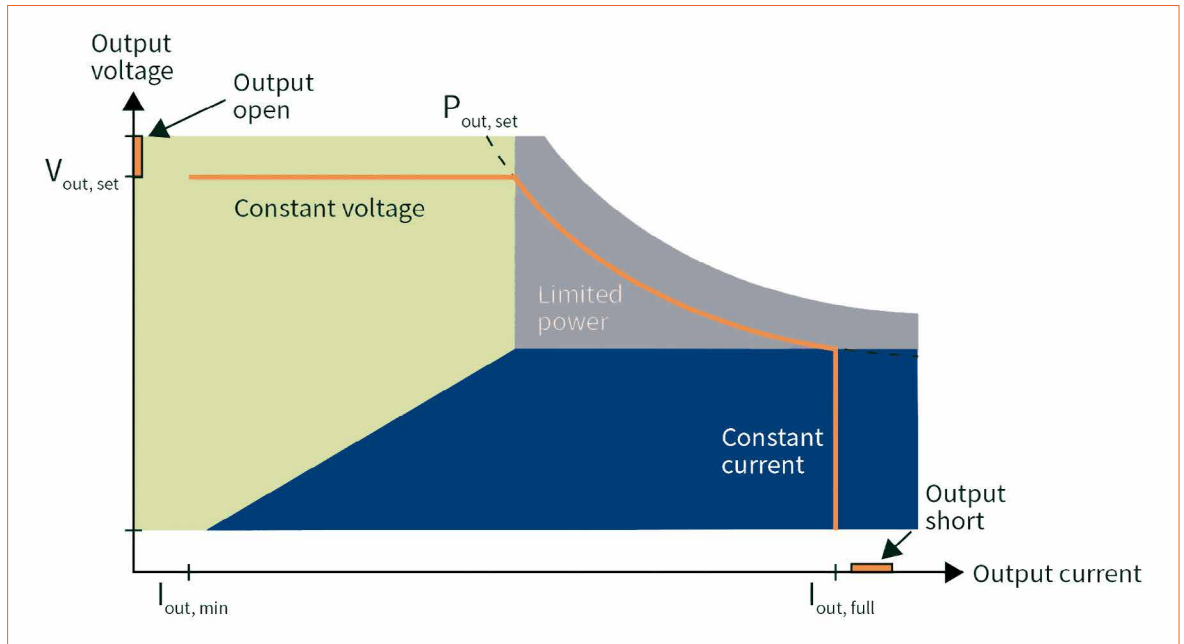

The market demand for ever-expanding LED-driver lifetime requires thorough design, testing, including 'highly accelerated lifetime testing' (HALT), and 'highly accelerated stress testing' (HAST), and that the controller recognizes potentially dangerous situations and reacts appropriately.

### Protection Features

A comprehensive set of protection features makes the new driver robust against failures and unsafe conditions. Two of the protections are output under- and overvoltage protections that commonly occur when the output is shorted or disconnected from the LED array.

As desired for up-to-date LED drivers, it offers multiple parameters to configure the reaction; this includes the override of the default reaction, such as auto-restart or latch mode. Furthermore, an adjustable blanking time permits monitored signal perturbations due to the possibility of masking the switching noise and disallowing false triggering of the protection schemes.

Similarly, the input over- and under-voltage protection allows for a flexible system while maintaining stability from adverse events on the AC line. This allows, for example,

the adaptation of the LED driver behavior to a weak power grid. In fact, frequent voltage fluctuation in these grids usually triggers the under-voltage protection for classic devices. The IC offers, in contrast, a more significant margin by configuring the threshold values and prevents most light-off situations due to grid fluctuations.

Another important feature is over-temperature protection as the long-term reliability of the LED array and the LED driver is often dependent on their operating temperature and exposure to over-temperature events. An internal or external temperature sensor can be employed to sense, and trigger this protection function. The internal sensor protects the IC and any external components that have sufficient thermal couplings with the device. The external sensor can be placed strategically to protect external components such as transformer, MOSFETs or the LED array.

The internal temperature protection initiates a shutdown in case the temperature exceeds a critical level. The external temperature protection reacts if a critical 'negative temperature coefficient' (NTC) resistance passes a threshold. This feature provides additional functionality like adaptive

temperature protection. It reduces the output current until the temperature is below the respective threshold to protect the load or the driver against over-temperature. Its functioning principle is quite simple: as long as the resistance of the NTC is below its temperature threshold, the driver reduces the current by a programmable step size. Once the resistance of the NTC is higher than the temperature threshold, the device increases the output current stepwise again. In short, the controller ensures operation below a critical temperature extending the operating life of the driver. If a reduction down to a minimum current level does not stop the over temperature situation, it will then trigger over-temperature protection and shuts the LED current off. For all over-temperature protection cases, the controller will only restart after the temperature drops below a configurable threshold. Over temperature-protections are essential to ensure the safety of users by preventing severe accidents and by saving components from failures. In fact, high temperatures are generally associated with faster device aging and deteriorating performance. Additionally, the GET command of the UART, temperatures can be read out. This enables the user to implement regular monitoring of the driver

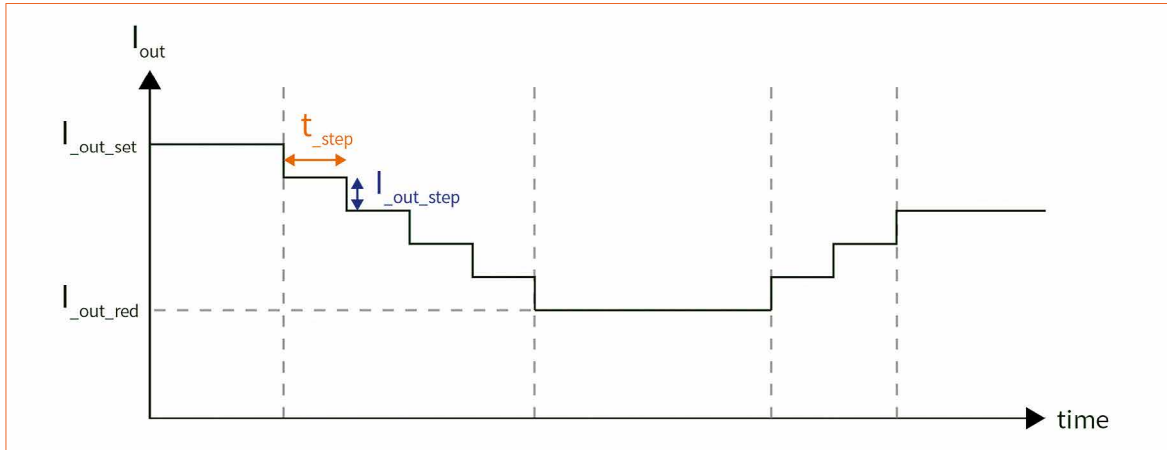

**Figure 4:**  
Adaptive operating principle of the external temperature protection opportunity

temperature. Some ways of using these data are the recording of temperatures, forecasting the lifetime of the driver, and supporting predictive maintenance.

The extensive set of configurable protection mechanisms ensures safe, reliable, and robust LED drivers for a wide set of use cases.

### Conclusion

Unique features like the UART interface, multi-control-operation mode, or the incorporation of robust and comprehensive protections make this solution an excellent LED-driver IC and a perfect match for sophisticated applications. It is also worth mentioning that the driver was designed for primary side regulation (PSR). PSR permits

to save external components and reduce noise. Programmable parameters similar to multimode operation enable using the same hardware for several applications thanks to a simple software configuration and then saves many different variants, making it possible to save costs thanks to a smaller bill of materials (BoM). ■

### References:

[1] XDPL8221, [www.infineon.com/xdpl8221](http://www.infineon.com/xdpl8221)

## HEP power for light

Comprehensive Portfolio  
Customized Solutions  
Smart Dimming Technologies  
Full Certification

### DALI DT8 2-Channel

- for **tuneable white**
- DALI & wireless Radio Control
- current setup by NFC
- 200 - 1050 mA
- 5 - 45 W



### Intrack Adapter

- for common **tracklight systems**
- current adjust via DIP switch
- constant current, low ripple
- for class II luminaires
- 400 - 900 mA
- 9 - 34 W

### LV-DC SELV 48 V

- for common **tracklight systems**
- current adjust via DIP Switch
- non-dim, 1- 10 V dim or DALI
- 350 - 700 mA
- 1.1 - 28 W



[www.hepgmbh.de](http://www.hepgmbh.de)  
[info@hepgmbh.de](mailto:info@hepgmbh.de)

HEP GmbH D-58579 Schalksmühle Germany  
Ramslöh 10 Tel: +49 (0) 2355-50919-0

# Fluorescence-Free Radiant Flux Measurement of UV LEDs

With the improvement of UV LEDs over the last few years, the number of possible applications increased and performance measurement became more important. Radiant flux measurement is compromised by fluorescence of the measurement equipment, namely the integrating spheres. Mike Clark, business development manager, Ralf Zuber, development manager, and Mario Ribnitzky, development engineer at Gigahertz-Optik, give background information and discuss a more suitable sphere material as well as its peculiarities in order to be able to perform spectral radiant flux measurements with the lowest possible measurement uncertainty. The details refer to measurement with the TFUV10-V01 system.

Developments in UV LED technology continue to raise the quantum efficiency of devices as well as improve their package design. This has resulted in steadily increasing radiant flux and reliability whilst costs decrease thereby allowing UV LEDs to replace conventional UV sources in many applications. Of particular note is the performance and lifetime now achieved by UV-C LEDs, which enables new application areas including water purification in domestic products and air purification systems, for example, as well as replacing deuterium lamps in spectroscopic instrumentation such as HPLC equipment.

Therefore, the accurate and traceable measurement of UV LEDs has become increasingly necessary. In addition to the measurement of spectral irradiance, the measurement of spectral radiant flux is fundamentally important. Typically, either an integrating sphere or a goniometer-based system is used for the measurement of radiant flux. Integrating sphere measurements are generally preferred, particularly for product testing and binning, as they are significantly faster and the facility is usually more cost-attractive.

## Measurement Challenges

However, UV measurements encounter more challenges than similar visible light tasks due to a number of issues including detector sensitivity, calibration and fluorescence. Available measurement devices typically possess a lower spectral responsivity in the UV than in the visible region, which reduces their signal-to-noise, especially in the UV-B and UV-C, during calibration and subsequent measurements.

Only a small selection of calibrations lamps is available compared to those available for the visible region. Furthermore, the available calibration sources (typically deuterium lamps) provide lower signal levels and are not as stable as the widely used halogen lamps most commonly used for visible light calibrations. It should also be mentioned that the calibration source aging is generally much more pronounced in the UV compared to the visible spectral region. As a result, the calibration of UV spectroradiometer equipment can be quite complex requiring the combination of deuterium and halogen lamps.

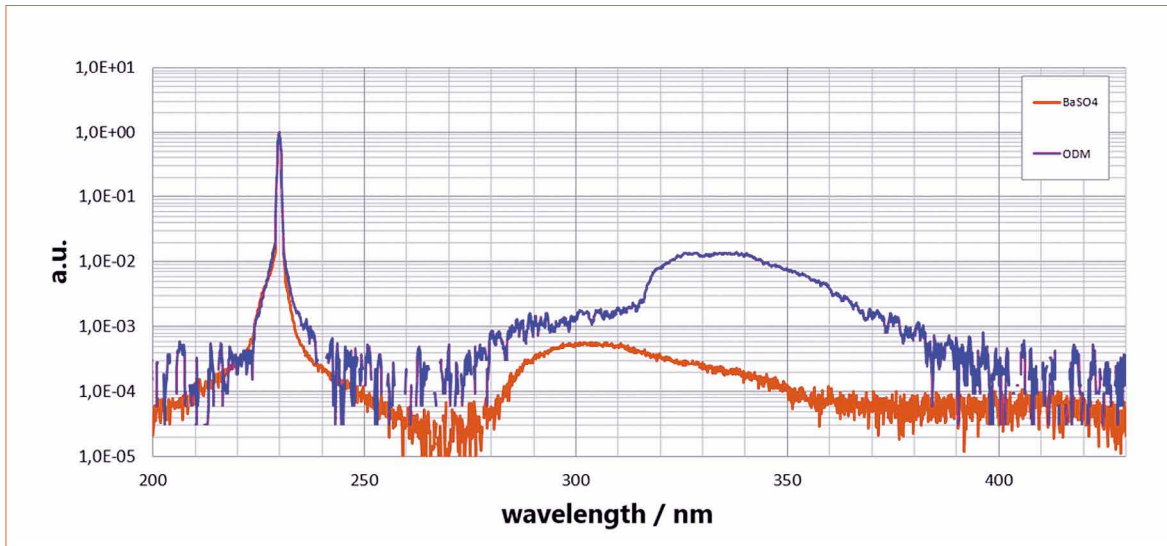

**Figure 1:** Measurement of an ODM and a barium sulfate coated integrating sphere with 230 nm excitation wavelength. The signal that can be seen between 280 nm and 400 nm is caused by fluorescence in the integrating sphere

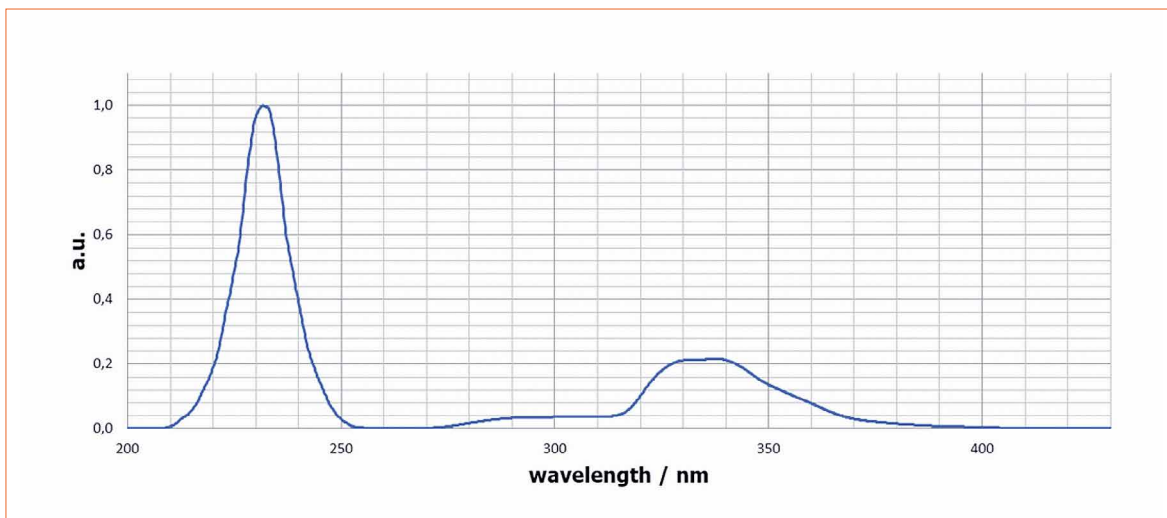

**Figure 2:** Fluorescence resulting from a simulated 230 nm LED in an ODM sphere can easily be in the region of 20%

Finally, fluorescence is a challenge in the UV that is not usually relevant or considered when measuring visible light. It can result in severe errors in UV measurements if it is not properly understood and appropriately dealt with. Many materials tend to exhibit some UV excited fluorescence, even with low levels of UV irradiation, which can falsify measurement results. This is the case for the common integrating sphere coating materials barium sulfate and ODM (a synthetic coating). Additionally, any material contaminants and surface pollutants will increase the fluorescence of the integrating sphere materials. Due to the fundamental principle of integrating spheres (multiple reflections to achieve constant irradiance level in the sphere; gain factor due to high reflectivity), fluorescence is especially important for these measurements (and calibrations).

This article discusses the more suitable sphere material as well as its peculiarities in order to be able to perform spectral radiant flux measurements with the lowest possible measurement uncertainty over an extended period of time.

### Fluorescence

In order to determine the magnitude of any fluorescence affects within an integrating sphere it is convenient to use a tuneable laser (e.g. OPO) to measure the fluorescence resulting from different excitation wavelengths (Figure 1). With such a tuneable laser different excitation wavelengths in the UV can be produced and coupled into the integrating sphere under investigation. The resulting signal, including any fluorescence affect, can be measured with an appropriate spectroradiometer

measurement system so long as the stray light rejection of the measurement system is sufficient.

The additional signal shown in figure 1 (between 280 nm and 400 nm) is caused by the fluorescence of the sphere itself and is a measurement error. A stray light corrected spectroradiometer with stray light level of lower than  $1E-5$  was used for this measurement. Furthermore, part of the actual measurement signal must be absorbed at 230 nm in order to produce this fluorescence. The fluorescence signal of  $1E-2$  shown arises from just a single monochromatic excitation wavelength. Measuring a 230 nm LED with a given FWHM bandwidth, for example, would stimulate fluorescence throughout the entire spectral range of the LED and the fluorescence contribution would be

**Figure 3:**  
Fluorescence at 300 nm reduced by a factor of 28 for a pure barium sulfate coated sphere after ageing

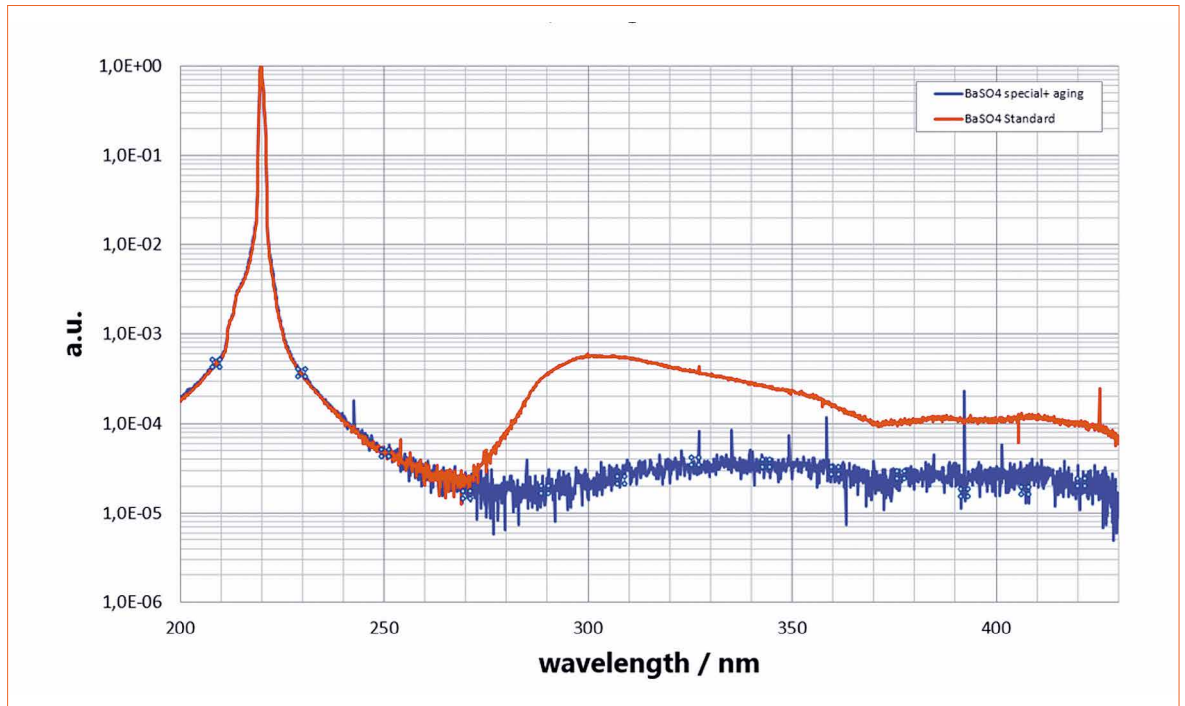

significantly greater. Therefore, fluorescence is clearly a significant contribution to measurement uncertainty for such measurements and can easily be in the order of 20% (depending on the spectral distribution of the light source and the integrating sphere used). Figure 2 shows an example for an ODM (synthetic material) sphere measurement of a 230 nm LED.

The dominant cause of fluorescence lies in contaminants such as hydrocarbons and other organic material that forms on or penetrates the surface of the sphere coating [3, 6]. It is usually only excited at wavelengths below 250 nm. Therefore, for measurements at wavelengths >250 nm the effect of fluorescence is less critical, as long as fluorescence effects are also considered during calibration. This is the case, for instance, if an integrating sphere is calibrated with a halogen lamp (significant signal only >250 nm) and measurements are performed >250 nm. However, this changes if the calibration is performed with either a deuterium or xenon lamp as they both produce significant output below 250 nm which would result in some fluorescence affects thereby increasing the calibration uncertainty.

### Barium Sulfate or ODM?

The measurement data from figure 1 shows that the fluorescence of an untreated ODM sphere is fundamentally higher than that of a barium sulfate sphere. However, what matters is the magnitude of the remaining fluorescence after a special treatment of the sphere coating. Measurements show that the fluorescence properties of ODM can be reduced but not completely eliminated. This is in line with the publication in LED Professional (October 2018, Issue 63 Link [1]), where the fluorescence of ODM-like material was reduced from 0.9% to only 0.05% at one excitation wavelength. Although the fluorescence was reduced, it could not be completely avoided. Consequently, this still results in a measurement error. For the aforementioned UV LED this would still be an additional measurement error in the range of about 1%. PTB has also published a paper confirming this [4, 5]. In contrast, the fluorescence of integrating spheres with a particularly well-prepared barium sulfate coating can be reduced even further than that of ODM (Figure 3).

The fluorescence at 300 nm, for example, could be reduced by a factor of 28. For the aforementioned

UV LED measurement, this means a much smaller measurement error of just 0.1%. For this reason, the PTB is again using UV-aged barium sulphate coated spheres in the UV for this type of measurement [2].

### Recurrence of Fluorescence?

Another uncertainty is the temporal stability of these spheres. In other words, does the fluorescence return? The answer is a very clear, "yes". The rate at which it does return depends on contamination by pollutants such as hydrocarbons and other gases as well as the influence of humidity on both coating types (ODM or barium sulphate) [3]. Therefore, the return of fluorescence affects is dependent on the prevailing ambient measurement and storage conditions. However, in all cases the fluorescence returns over a certain time frame, (Figure 4).

Therefore, a regular re-aging of the system is essential to ensure fluorescence-free measurements.

### Metrological Solution

In order to be able to implement this measurement technology, a UV spectral flux measuring system has been developed that incorporates an integrating sphere with a



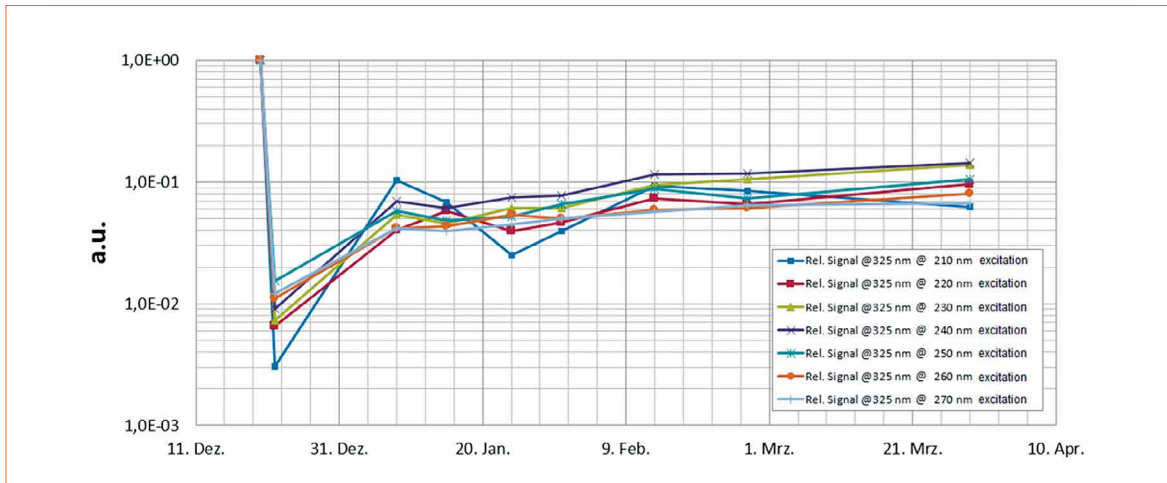

**Figure 4:** Recurrent fluorescence measured at 325 nm resulting from different excitation wavelengths. Lowest signal occurs immediately after treatment

specially pre-treated barium sulfate coating. In addition, an effective system should include a treatment lamp along with the necessary application protocol that allows the user to keep the system fluorescence-free. Figure 5 shows such a measurement system.

The measurement system enables long-term fluorescence measurements from 200 nm to 550 nm at 1 nm optical bandwidth and  $\sim 0.16$  nm/pixel resolution. In addition, different 2-Pi calibration lamps (deuterium and halogen) are available for the measurement system in order to calibrate the entire spectral range. Of particular importance is the 2-Pi geometry of the calibration lamps, which makes it possible to achieve low measurement uncertainties for UV LED measurements because the measurement geometry during calibration is very similar to the geometry during the subsequent LED measurements. Of course, the calibration sources should be calibrated by an accredited laboratory with traceability to an NMI like PTB or NIST.

### Conclusion

Fluorescence is a significant contribution to measurement uncertainty when the radiant flux of UV sources that emit at wavelengths less than 250 nm is measured using integrating spheres. Fluorescence can easily increase the uncertainty in the range of 20% when using conventional integrating spheres for specific UV measurements. This issue is becoming more and more important due to the increasing number of UV LED applications and range of products incorporating deep UV LEDs. In order to permanently reduce the measurement uncertainty, special treatment methods are required in addition to a suitable integrating sphere coating material and production processes. Measurements show that barium sulphate is better suited to deep UV than synthetic coatings like ODM as it is possible to maintain lower fluorescence properties. Although ODM has the advantage of higher reflection properties, this advantage is countered by



**Figure 5:** Example measurement system for permanent fluorescence-free measurements

increased measurement uncertainty due to fluorescence, especially for sources producing radiation below 250 nm. For sources emitting only at wavelengths greater than 250 nm ODM generally remains a very good choice due to its increased reflectance compared to barium sulfate. Since the fluorescence after the special pre-treatment slowly but steadily increases with time, the concept of an ongoing-treatment is also necessary for this application. With the described TFUV10-V01 measuring system, a complete metrological solution is offered that takes into account all aspects of this topic (with resulting fluorescence less than 0.1%) providing the user with long term accuracy. ■

### References:

- [1] Dr. Tobias Roesener, Challenges in UV Measurement, LED professional Review, Issue 63 | Sept/Oct 2018,
- [2] Gesprächsnotiz Peter Sperfeld, PTB
- [3] Shitomi H., Saito I., Photoluminescence from White Reference Materials for Spectral Diffuse Reflectance upon Exposure to the Radiation Shorter than 400 nm, Newrad 2005
- [4] Pape S., Sperfeld P., Barton B., Stock K., Analyses and reduction of fluorescence on PTFE-coated integrating spheres, [https://www.ptb.de/cms/ptb/fachabteilungen/abt4/jahresbericht-aktuelles/nachricht-aus-dem-jahresbericht.html?tx\\_news\\_pi1%5Bnews%5D=748&tx\\_news\\_pi1%5Bcontroller%5D=News&tx\\_news\\_pi1%5Baction%5D=detail&tx\\_news\\_pi1%5Bday%5D=1&tx\\_news\\_pi1%5Bmonth%5D=10&tx\\_news\\_pi1%5Byear%5D=2010&cHash=e2cf784ed439321f83cabeba493669f3](https://www.ptb.de/cms/ptb/fachabteilungen/abt4/jahresbericht-aktuelles/nachricht-aus-dem-jahresbericht.html?tx_news_pi1%5Bnews%5D=748&tx_news_pi1%5Bcontroller%5D=News&tx_news_pi1%5Baction%5D=detail&tx_news_pi1%5Bday%5D=1&tx_news_pi1%5Bmonth%5D=10&tx_news_pi1%5Byear%5D=2010&cHash=e2cf784ed439321f83cabeba493669f3)
- [5] [Albert E. Stiegman, Carol J. Bruegge, Arthur W. Springsteen, "Ultraviolet stability and contamination analysis of Spectralon diffuse reflectance material," Opt. Eng. 32(4) (1 April 1993)
- [6] P.S., Li Z., Arp U., Lykke R. K., Ultraviolet characterization of integrating spheres, Applied Optics, 2007

# New Ecodesign Regulation on Flicker and Stroboscopic Effect in LED Lighting

As light quality continuously becomes more relevant, flicker also comes into focus of the Ecodesign and Energy Labelling regulations. Flicker and Stroboscopic Visibility Measure (SVM) will be introduced by the revised Ecodesign Regulation for light sources by the end of 2019. Miko Przybyla and Pawel Czarnecki from GL Optic explain what this means, how to measure correctly, and which equipment is appropriate.

Evaluation and measurements of optical flicker is a new task for electronic developers who provide solutions for LED lighting applications. When new drivers, power supplies or dimming electronics is purchased or designed, engineers need to consider LED lighting performance parameters including Temporary Light Artefacts (TLA) i.e. flicker and stroboscopic effects. The challenge is that up until now there was no regulation or agreed standard describing acceptable or minimum flicker levels. Soon this situation may change because the European Commission is currently working on revision of the Ecodesign and Energy Labelling regulations on light sources, including LEDs.

Future regulation will most likely include minimum requirements on flicker. Should this change be introduced by the end of 2019, it can come into force in 2021. Member states and national lighting associations are discussing what the recommended level and appropriate metric to evaluate flicker will be. At present the Stroboscopic Visibility Measure (SVM) is introduced in the Ecodesign Regulation for light sources by

the Member States (Regulatory Committee) with a limit of  $\leq 0.4$ .

Including minimum requirements for flicker in the European standard will be the first international legal document after California Title24 to recognize flicker parameter and setting the standard level. Should a limit of  $\leq 0.4$  be officially agreed it could mean that a major part of available LED mains connected lighting products will not comply with the standard.

Before these changes are introduced in Europe let's take a closer look at basic flicker metrics like flicker index, flicker percent and frequency, once again to make sure we know how to measure these values and what the available instruments and suggested measurement methods are. Additionally, it is important for all lighting professionals to understand the use and the meaning of the new Stroboscopic Visibility Measure (SVM), a metric developed at Philips Research. This article discloses details of measurement systems and discusses ways to eliminate the flicker effect.

## Light Flicker in LED Lighting Systems

In addition to the spectral power distribution of the light and its intensity, light flicker is one of the factors influencing the visual comfort in the workplace. Light flicker is defined as a rapid, periodic change in light intensity. Under these conditions, most people are unable to see a light flicker higher than 80 Hz, which is considered to be the lower limit of visible frequency.

Long-term light flicker can be the cause of visual discomfort at work. It can cause headaches, migraines and epileptic seizures. In an industrial environment it can provoke accidents involving people, because the stroboscopic effect caused by light flicker leads to a disturbance in the perception of the speed of rotating objects, e.g. machine parts. Flicker is highly undesirable in sports facilities, concerts, where high quality film cameras are used, often with the possibility of fast-frame recording (60 frames per second or more) when the effect of changing the intensity of light becomes visible. Peripheral vision is more sensitive to the flicker effect, which can disrupt the concentration of the vehicle's driver and redirect attention to the light source, thus posing a risk to road safety.

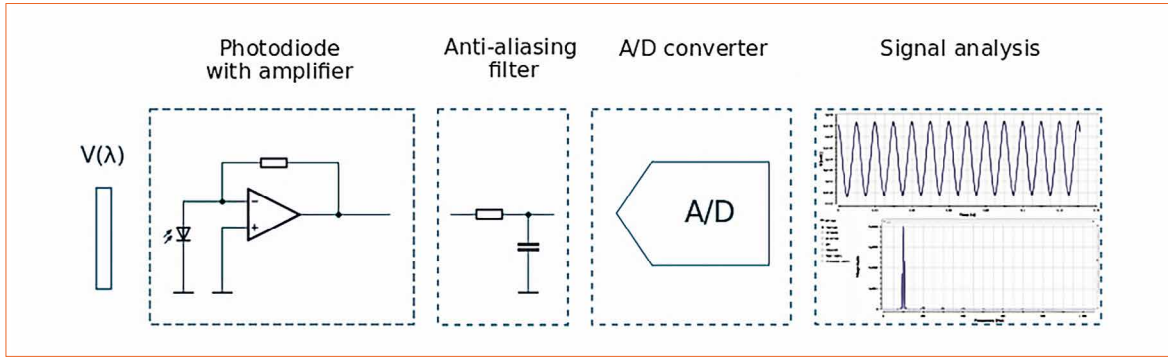

**Figure 1:** Diagram of the system for measuring light flicker

The rapid development of lighting technology based on LEDs has made this issue more and more relevant due to the very fast response time of these types of a semiconductor light sources at the level of a few dozen, or several dozen ns. In incandescent bulbs, the reaction time, and thus also the heart rate, was limited by the large thermal inertia of the fibre. Therefore, flicker is more likely to be visible in LED lighting installations.

### Measurement Systems

Photometric devices consisting of a high performance photodetection system (photodiode with transimpedance amplifier) supplemented by an optical V-lambda filter allowing the sensitivity curve of the system to be adjusted to the characteristics of the human eye shall be used to measure the light flicker parameters of the light source.

### Basic flicker parameters

When characterizing light flicker, one of the basic issues is to determine the light flicker frequency of the light source.

In tungsten halogen or fluorescent lighting, the flicker frequency is usually twice the frequency of the power grid, so in the European Union it is 100 Hz, and in the USA, for example, it will be 120 Hz. Since there are often additional sources of flicker when measurements are made outside the laboratory, a Fast Fourier Transform (FFT) is used in the measurement systems to analyse the signal in order to identify all the components present in the signal.

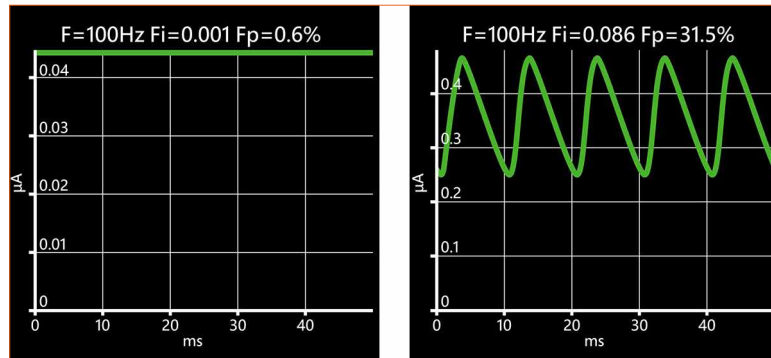

**Figure 2:** LED E27 bulb, 12 W 230 V AC (a), multi LED module supplied with 230 V AC (b). The measurements were made with the GL SPECTIS 1.0T Flicker with a sampling frequency of 125 kHz

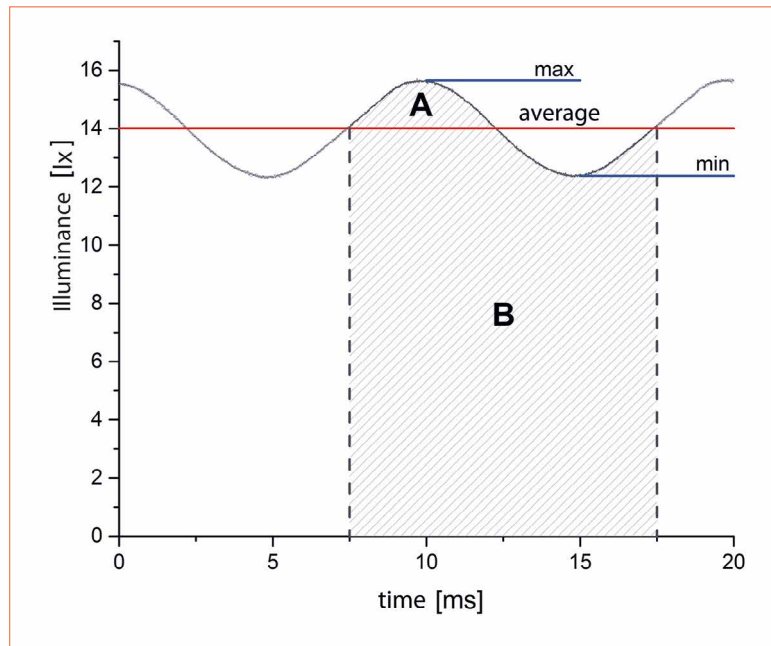

**Figure 3:** Time diagram of the light flicker signal

It is also important to be able to see the registered signal on a time chart, which enables the evaluation of the shape of the signal (sinusoidal, rectangular, triangular), modulation or frequency.

The most important measurements from the point of view of an engineer who evaluates the flicker of LED light are based on the measurement of signal amplitude (flicker percent) and shape (flicker index). Figure 2 shows the sinusoidal change of light intensity (photodiode current) over

time. The chart shows the most important amplitudes and the areas under the curve used to determine the flicker measures.

Flicker Percent (FP) is the simplest measure of flicker based on maximum and minimum flicker amplitude. If the waveform changes (while maintaining the values of the flicker amplitudes), e.g. from sinusoidal to rectangular, or if a straight wave is filled in, the value of the flicker factor remains the same. The range of possible values ranges

from 0% (with no flicker) to 100%. IEEE 1789-2015 recommendations suggest flicker percent values <0.08 times the flicker frequency (8% at 100 Hz). This is a low-risk level. The second, higher criterion assumes that the flicker level will be in the NOEL (no observable effect level) and will not exceed 0.0333 x flicker frequency (3% for 100 Hz).

$$FP = \frac{\max - \min}{\max + \min} \cdot 100\%$$

where

*max* = maximum signal amplitude,

*min* = minimum signal amplitude.

Flicker Index (FI) is a measure of flicker based on the determination of integral under the curve. In contrast to the previous measure, the flicker index takes into account not only the amplitude of the waveform, but also its shape and filling. The value of the measurement may range from 0 (in case of lack of flicker) to 1. The American organization IES recommends that light sources should not exceed the value of flicker index=0.1.

$$FI = \frac{A}{A + B}$$

where:

*A* = integral under the curve to the level of the mean value,

*B* = integral under the curve from the level of the mean value to zero.

### Putting all flicker parameters together

Since flicker can be described in many different ways with the use of specific parameters, one might want to know which lighting product has better optical performance parameters and which ones are worse. In this manner a new SVM metric can become helpful because it considers frequency, modulation type and the modulation depth.

Stroboscopic Visibility Measure (SVM) is a new measure of the probability of stroboscopic effect.

It was developed by a group of scientists from Philips Research taking into account the visual perception of different frequencies of the light source flicker. A value equal to or greater than 1 means that the stroboscopic effect will be visible to the observer. Unlike flicker index and flicker percent measures, SVM takes into account the different sensitivity of the human imaging system (eye and brain) with respect to flicker frequency.

$$\left( \sum_{m=1}^{\infty} \left| \frac{C_m}{T_m} \right|^n \right)^{1/n}$$

The SVM parameter corresponds to the sum of the Fourier  $C_m$  transform components divided by  $T_m$ , understood as the detection threshold of the corresponding frequency for sinusoidal modulation flicker.

The measures discussed in the article refer to the actual optical measurements of the intensity of the tested light source. It should be noted that the so-called flicker meters built on the basis of the IEC 6100-4-15 standard, i.e. devices for short-term measurements (Pst index - 10 minutes) and long-term measurements (Plt index - 2 hours) of fluctuations in power network voltage (120 V or 230 V, 50 or 60 Hz) caused by time-varying reactive power of disturbing receivers, are referring electromagnetic compatibility test and not the optical flicker performance. This standard assumes measurement of network voltage rather than directly measuring the flicker of light source intensity, simulation of the eye and brain system and the use of incandescent light sources.

### How to Measure

Most often manufacturers want to specify the flicker parameters of LED modules and lamps in laboratory conditions in order to include these parameters in the data sheet. Such a test should be performed in a dark-room, where there are no other light

sources that could interfere with the measurement. A measuring instrument directed towards the light source should be mounted on an optical bench or tripod, because hand vibrations can cause additional low frequencies in the signal. The PN semiconductor connector of an LED has a negative temperature coefficient, so the current flowing through the LED will increase as it heats up, so you should wait several minutes to obtain stable temperature conditions of the module, which will allow you to complementarily determine the flicker parameters of the light source.

Another method to measure flicker would be to install a flicker measuring device in an integrating sphere which might simplify the measurement process for engineers who do not always have the possibility to use a laboratory to make fast evaluations when checking components and newly designed circuits. An integrating sphere with appropriate measurement instruments and software can create a table top measurement station.

On site measurement of several light sources installed in the building, for instance, is a much more difficult task because of the superposition (mutual overlapping of waves) of changes in light intensity, which occurs then. A periodic audit of the installation can, however, reassure us about the actual lamp performance, and increased flicker may suggest damage to the power supply systems or changed thermal conditions of the LED module inside.

### Available Instruments

Light flicker meters vary in measurement time range, sampling frequencies, maximum transmission frequency, and frequency resolution depending on the size of the FFT. Not all manufacturers follow the guidelines of light flicker testing organizations. High-end devices sample a signal with a high oversampling rate of 10x higher than

the highest expected frequency of the measured signal, which is important for accurate reproduction of the flicker signal shape. When designing lamps for specific applications in production halls or sports facilities, it may also be interesting to understand and consider the stroboscopic effect, so the presence of this parameter in the calculations will be important in this case.

The United States Department of Energy (DOE), a US government agency that deals with energy efficiency and renewables, has reviewed equipment to measure the flicker of light sources. In its report it compared 7 portable measuring devices plus one application for smart phones. The devices were compared with a reference stationary system.

For this purpose, 12 different light sources were used; each with different flicker characteristics. The devices were compared both in terms of accuracy of measurement of the basic metrics of flicker: flicker index and flicker percent, as well as the correctness of detection of the dominant frequency in the signal. Some sources were measured in maximum brightness mode and in 30% brightness mode.

Only two European instruments including Gigahertz and the GL SPECTIS 1.0T Flicker from GL Optic were included in the comparison and were able to measure the SVM (stroboscopic visibility measure). The correctness of SVM measurement was also compared with a reference device.

### Conclusion

It is crucial to remember that the only component that has direct influence on flicker performance is the driver. The higher driver capacity the better filtering effect to eliminate the influence of power supplied from the mains. This results in higher complication of the design and higher costs. In order to select better components and optimize the product flicker performance there needs to be consideration during the entire process of the development. Available metrics and instrumentation may help to deliver better LED lighting products. Soon the whole industry will need to comply with the European standards in this field. ■

# First class color-mixing quality

PATENT

comes from our light guide rod and its innovative application - STONEHENGE, the new LED optic engine.

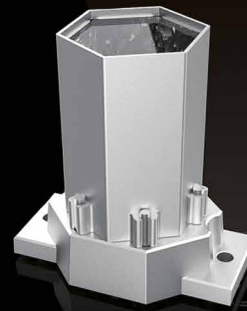

- Specific and targeted shapes and lengths that are designed and more beneficial to color-mixing.
- Industry leading color-mixing optic solution through multi light guide rods array.

- Optimized optical design brings the perfect balance of color-mixing and efficiency.
- Adapting to the LED that has RGBW or more colors in one.

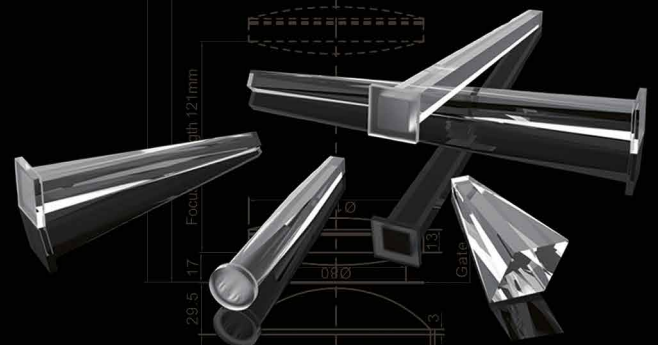

- Primary applications  
Wash \ Spotlight \ Imaging profile lighting in photography

On the road of optics innovation, we never stop.

# Measure Influence of Discomfort Glare on Task Performance Using the Stroop Task to Circumvent Participant Assessments

Glare is certainly an everlasting heavily and controversially discussed topic. Many attempts have been undertaken to objectify the research and the discussion but there is still need for research. In his Master Thesis "Peripheral Discomfort Glare and Its Influence on Task Performance on Display Screen Equipment", Mads Mårbjerg, lighting designer at Buro Happold Engineering Berlin, used the Stroop Task to find out if it is appropriate to research, quantify, and objectify the amount of glare and discomfort caused by LED lights with this method.

The unpleasant experience of discomfort glare is familiar to most people, but understanding the intricacies behind the experience is far from completely understood by researchers. Research into this topic has been underway for almost 100 years now and lighting technology has changed much during this time. Modern LED technology is very different from much of the technology the research is based upon. The scientific community and regulatory institutions are having difficulties keeping up with the creative ways LEDs are implemented and projects might be built without actual scientific studies to support them.

Discomfort glare is an area which is highly relevant when designing healthy lighting environments, but it is also an incredibly complex topic to research. This study used a bottom-up approach to understand the underlying literature, design an experiment, analyze and interpret the results to reveal the challenges of this type of research and hopefully contribute to the field.

## Background Research

### The human visual system

Understanding the intricacies of visual perception requires a foundational basic knowledge and understanding of the human visual system. The process of vision is a matter of taking in information through the medium of light, relay, filter and interpret it. During this process light rays are converted in the eye to neural signals and sent through a complex pathway in the central nervous system to form the view humans perceive and can interpret consciously [1].

Light rays from the environment enter through the tear film, cornea, pupil and lens of the eye and pass through the aqueous humor (liquid), filling up the eyeball, before it reaches the retina at the back of the eye. This journey minimizes light scattering and the refractive attributes of the changes in materials are responsible for the optical power of the eye [1].

The light passes through the retina where specialized cells convert the photons to neural signals. The photoreceptor cells are first in line. They are represented by two types, called rods and cones, containing a photopigment with different spectral sensitivity. The rod photoreceptors are active in dim light conditions while the three types of cone photoreceptors are active in bright conditions, where each type is sensitive to either the red, green or blue wavelengths. When the photopigment gets excited by photons, a series of biochemical changes, called phototransduction, occur. This produces an electrical current as an output passed on to the first of the collector cells in the retina, neurons called bipolar cells. There are different types of bipolar cells, one known type for rods and 10 types for cones. Each photoreceptor can have connections to several bipolar cells to improve sensitivity. Bipolar cells act as a relaying station, where neural signals from cones get relayed to ganglion cells, while neural signals from rods gets relayed first to amacrine cells (another type of collector cell) and then to ganglion cells. Ganglion cells are the first cells in the visual pathway which can respond with an action potential by sending a signal to the higher central nervous system (CNS) locations. Entangled with the photoreceptors, bipolar and amacrine cells are horizontal cells and interplexiform neurons, the last two collector cells, which convey information and feedback in between the cell layers. The axons of all the ganglion cells accumulate at the optic disc and exits the eye through the optic nerve, passing the neural signals on to brain. The optic disc has no photoreceptors and does not elicit a response from light, making it a physiological blind spot in the eye [1].

A term of retinal processing, which in recent years has come to light of glare researchers, is receptive fields. The term covers an area of the retina that elicits a

retinal neuron response when stimulated by light. The receptive field of a single bipolar cell consists of the photoreceptors it is in direct contact with and all the photoreceptors and horizontal cells that can influence it. Since horizontal cells are entangled as previously described, they greatly extend the receptive field beyond the photoreceptor connections of the bipolar cell. The arrangement of receptive fields in the retina is a so-called center-surround pattern. This allows each bipolar cell to not only respond to a direct message it receives, but also to gather signals from neighboring areas and take in information about the bigger picture before relaying its information. This process assists in detecting edges and recognition of contrast, while maximizing the retinal contrast sensitivity in a wide range of background illuminations. Because of this, receptive fields have become a special area of interest in newer research of vision and glare, potentially promising a new way of predicting discomfort glare [2].

90% of the optic nerve fibers will terminate in the lateral geniculate nucleus (LGN) in the thalamus located in the vertebrate brain, as all other sensory signals do (except smell). The LGN gathers input from the cortical and subcortical centers of the cerebral cortex, the largest site of neural integration in the CNS, and performs complex visual processing, regulating the flow of visual information to the primary visual cortex, the striate cortex located in the occipital lobe. Here, certain areas are active when processing different information, e.g. motion stimulation and color vision. The magnocellular areas of the LGN likely process movement detection and low-spatial frequency contrast sensitivity, while the parvocellular areas likely process color and high-spatial-frequency contrast sensitivity to oversimplify. Other functions of the striate cortex worth mentioning is contour analysis and binocular vision [1]. The processing of low- and high-spatial frequency contrast

sensitivity is a recent field of interest in relation to discomfort glare, as Boyce & Wilkins [3] suggests needs to be further explored. The striate cortex communicates with the superior colliculus and the frontal eye fields. The superior colliculus, in the midbrain, does not analyze sensory information for perception but assists in visual orientation, foveation (bringing an object into focus), and control of saccadic eye movements (rapid eye movement to direct the fovea onto an object). The frontal eye fields, in the frontal lobe, receives input from the superior colliculus contributing to control of conjugate eye movements (coordinated eye movement) while also processing voluntary and reflex ocular movements (muscles controlling eye movement), as well as pupillary responses to near objects. The striate cortex transmits the analyzed visual information to the higher visual association areas, called the extrastriate cortex, for further interpretation [1].

The human visual system is working within boundaries as any other system in the human body. When the body is working on the thresholds of these boundaries, it becomes a cognitively demanding task. Doing this for a prolonged period will put strain on the system. Visual accommodation and adaption are the processes in which the eye attempts to keep focus and adjusts to brightness. This involves muscles in the eye stretching and loosening the lens, to control the refractive properties, and the iris and pupil to regulate the illumination of the retina. The background illumination can heavily influence how straining visual adaption is on the eye and in threshold scenarios this can lead to eye fatigue. The neural pathway is also bound by these boundaries as well as the eyes themselves [1]. The thresholds for the visual system are usually divided into spatial, temporal and color thresholds, representing targeted detail discrimination from background (e.g. luminance contrast, visual acuity), detection of flashing light

**Figure 1:**  
The Unified Glare Rating (UGR) formula

$$UGR = 8 \log_{10} \frac{0.25}{L_b} \sum \frac{L^2 \omega}{P^2}$$

against a uniform background (e.g. Bloch's law, flicker, electrical drivers), and color discrimination (e.g. LED binning, MacAdam ellipses) respectively [4]. This relatively brief examination of the visual system shows that discomfort glare can arise from multiple locations in the visual pathway with much research potential in the future.

### Light and glare

It is important to remember that discomfort glare is a product of an individual experience and contextual lighting. It occurs when one or more bright light sources are in direct view or causing specular reflection, making it difficult to ignore either physically or psychologically. It is not to be confused with blinding glare or disability glare, which makes it physically impossible or difficult to see or discriminate detail [5].

Discomfort glare is generally caused by (1) poor visibility of the information required to be obtained due to conditions being close to the detection thresholds, (2) under- or

overstimulation of the visual cortex (striate and extrastriate cortex) by spatial or temporarily repetitive patterns, or (3) distraction of the visual cortex by bright, moving or fluctuating objects in the peripheral visual field close to the temporal threshold [3]. The regulatory standard EN 12464-1 generally regulate light in terms corresponding to these causes: Illuminance, uniformity, discomfort glare, glare shielding, veiling reflections and reflected glare, flicker and stroboscopic effects.

### Predictive glare models

Research on glare began back in 1925 [6] and resulted in the first predictive glare model in 1949-1950 [7,8]. Various models were developed throughout the years until the CIE adapted the Unified Glare Rating (UGR) model in 1995 [9] (see figure 1). The UGR model serves as a compromise between some of the previous prediction models and simplifies the expression for easier application [4,6,10].

The expression in the UGR model first calculates the influence of each glare source in terms of luminance output, solid angle covered by the glare source, and the location in the

visual field. The influences of all glare sources are summed up and multiplied with an expression for the background luminance. Lastly, the result is adjusted to a smaller scale for easier interpretation. It can be discussed whether it is realistic to separate the influence of the background luminance and the influence of the luminance from the glare sources as the UGR model suggests. In what practical scenario does the glare sources not contribute to the background luminance? Another critique of any current prediction model is the use of Guth's position index P. The position index P was originally developed back in 1949 [7] for glare sources located above the line of sight since the goal was to assess electrical light sources mounted in ceilings. In 1979, Einhorn translated P into a mathematical expression, making it easier to apply in the digital age than a graphical X-Y chart [10]. However, the data, which P was based on, was obtained from experiments using outdated lighting technology, potentially making it less useful for modern environments. Additionally, it only covered the upper half of the visual field.

Iwata & Tokura [11] began testing the whole visual field, attempting to update the position index P, and in 2009-2010 Kim & Kim [12,13] continued the effort with a more systematic approach to devise a precise position index. With a relatively small sample size of 40 participants (32 in the first study and 8 in the second) they mapped the limits of the visual field the so-called borderline between comfort and discomfort (BCD curves). Their conclusion was that the limits of the human visual field was larger below the line of sight than above. The BCD curves showed a general sensitivity to higher luminance towards the center and decreasing when moving outwards (see figure 2). With the lower half of the visual field taking up the larger portion of the total field, it can be said to be more sensitive, though the data is still much too little to support a complete conclusion.

**Figure 2:**  
Mapping of the visual field in polar coordinates. Kim & Kim's mapping of the visual field (green) and their four BCD curves (yellow). Guth's BCD curves (red) only above the line of sight

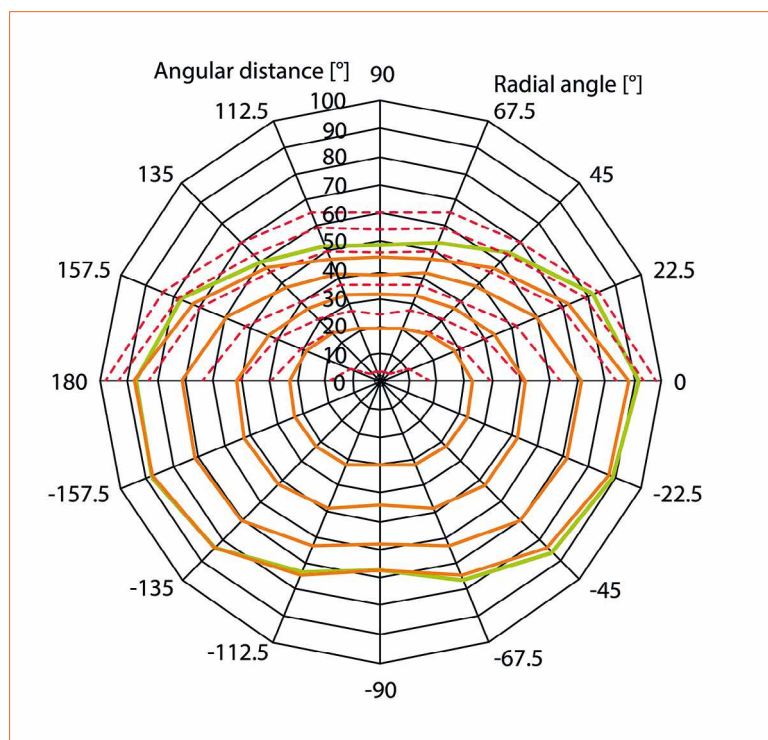



## Experiment

### Methodology

The background research on position index was an interesting topic to continue investigating. Luminance output of the source and background are, of course, major variables of discomfort glare, but the location of the source seems to play a major role as well, considering what was learned in the literature review of the visual system. Sources of light and/or activities in the peripheral visual field can easily demand the attention, removing it from whatever is in the focus. Generally, research on threshold values rely on participant assessments of discomfort, but an important question to ask is, under which conditions are the participants asked to assess their discomfort?

Kent et al. [6] made an experiment to test whether participants had a higher tolerance towards discomfort glare when asked to assess their discomfort level during a more cognitively demanding task compared to a less cognitively demanding task. The experiment showed a potential for higher tolerance among participants. Other studies by Logadóttir et al. [14,15] demonstrated how experimental bias within the assessment methodology itself could influence the participants assessments. The researchers attempted to find the preferred illuminance and CCT levels for a workplace environment in two separate experiments. They proved a centering bias, where the participant assessments always tended to fall in the center of the stimulus range presented to them. The experiments also proved an anchoring bias, where an adjustment of the end anchor steered the assessment in the same direction as the adjustment was made, meaning the higher the end anchor, the higher the preferred illuminance or CCT.

Learning from these studies [6,14,15], it was interesting to test whether it was possible to measure participant preference by cognitive

Criteria	Description
1	The visual task was required to be performed on a computer screen (Display Screen Equipment, DSE) to fit a modern work scenario.
2	The surrounding view of the computer task visible in the peripheral visual field is required to be a uniform surface to create minimal stimuli.
3	The glare sources are required to be located in the peripheral visual field.
4	The glare sources are required to be covering equal solid angles.
5	The glare sources are required to be individually controlled and have equal output.
6	The background luminance and glare source luminance are required to be independent of each other just as the UGR prediction model is defining it.
7	Adaption time should be minimized to lower total duration of the experiment.
8	Personal and experimental bias should be kept at a minimum as is realistically possible with the resources at hand.

**Table 1:**  
Criteria for the experimental setup

performance and leave out the assessments prone to bias.

#### The two fundamental research questions (RQ) asked was:

- Does discomfort glare influence task performance and how can it be measured? - (RQ1)
- If discomfort glare does influence task performance, where in the visual field does it influence task performance the most? - (RQ2)

Reviewing the experimental setups in the various studies [6,11,12,13,14,15], a list of criteria for the experimental setup was devised in an attempt at minimizing the experimental bias (Table 1).

The experimental setup by Kent et al. [6] was used as a starting point and adjusted to fit the scope of the experiment. It consisted of a wall screen covering the entire visual field of the participant sitting in front, on a chair, by a table attached to the wall screen. In front of the participant was a computer screen where the performance task would be presented. A digital 3D CAD model was constructed to design the locations and sizes of the seven test glare sources. It was of great

importance to design the sizes precisely in order for the solid angle to be equal. The glare sources were designed as boxes with powerful LED strips and aluminum foil installed to provide equal output. The boxes were then attached behind the wall covering the source holes cut out in the wall screen. Between the boxes and the wall screen, a translucent A4 paper was installed to diffuse the output, so as to produce discomfort glare and not disability glare. The source output was designed to be around 10,000 cd/m<sup>2</sup> but proved difficult to get precisely equal because of small construction and installation differences. The ideal background luminance also proved difficult to achieve because of limited access to lighting equipment, but an acceptable mean luminance of 34 cd/m<sup>2</sup> was achieved on the wall screen, as Kim & Kim [12,13] had implemented. See the experimental setup on figure 3.

Measuring participant preference without participant assessment does not seem to be attempted much, but one study provided a small template. Rodríguez, Garretón & Pattini [16] attempted to measure

**Figure 3:**  
Behind (left) and  
front (right) of the  
experimental setup



**Figure 4:**  
Experimental  
procedure overview

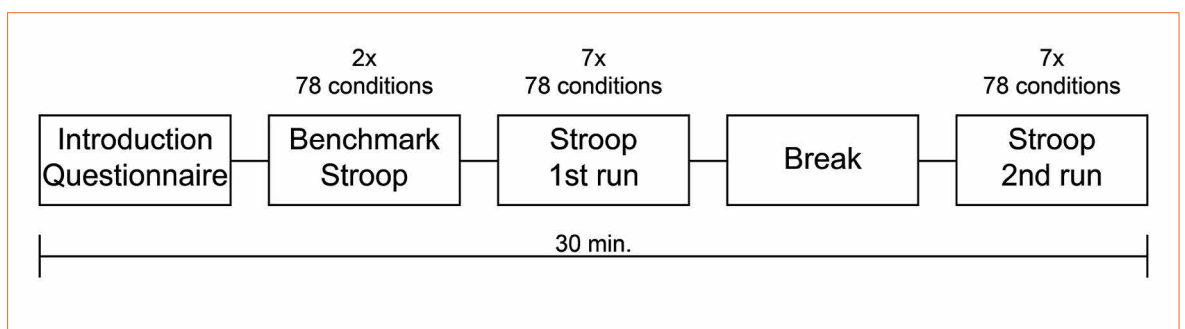

the effect of daylight, not strictly discomfort glare, on task performance on a computer screen. The performance task used in the study is a well-known cognitive test used in psychology called the Stroop task. It is visual task where a word is presented on a screen in a certain color, which is either in congruent condition (color matching the meaning of the word, e.g. the word blue presented in blue) or incongruent condition (color not matching the meaning of the word, e.g. the word blue presented in green). The participant is supposed to report the presented color and not the meaning of the word as quick as possible, shuffling randomly between congruent and incongruent conditions. The test typically shows incongruent conditions having a slower response time (RT) than congruent conditions, and the difference in RTs between the two conditions is known as the Stroop Interference (SI). The SI is usually explained by the brain being quicker to process words than color, making participants think of the meaning of the word before the actual color. A measurement of SI is argued to be an indicator of

selective attention, showing if the participant was distracted during the task. This argument made the Stroop task interesting to use in the experiment.

19 participants volunteered for the experiment. They were put through a questionnaire prior to the experiment asking for gender, age, nationality, profession (whether in lighting or not), issues with eyesight, use of eye correction (glasses or lenses), and how energized they felt in the moment. The most interesting question asked was whether they viewed themselves as glare-sensitive or glare-insensitive. This question was inspired by Rodriguez et al. [16] where self-reported glare-sensitives showed a larger SI than self-reported glare-insensitives. Testing if this result could be replicated became research question nr. 3 (RQ3).

After the questionnaire, the participants would begin the actual experiment. Two rounds of a Stroop task would be completed as benchmark tests, one round of a Stroop task consisting of 78 words presented on screen.

The participant reported the color of the letters by pressing a key marked with red, green or blue color and the computer would save their answer (right or wrong) and RT. Afterwards, the seven glare sources were switched on individually in random order and a round of a Stroop task was presented for each source. After a run of seven Stroop tasks for seven glare sources, the participant was given a small break. After the break, a second and similar run was initiated, only the glare sources were switched on in a different order. By using two runs, a mean RT for each source could be derived ensuring a bad round did not have too much of an influence on the data. The total duration of the experiment was around 30 minutes (Figure 4 - overview of the procedure).

## Results

The experiment resulted in 16 participants providing useable data for analysis. Rodriguez et al. [16] showed a Stroop interference (SI) of 0.080 seconds while this experiment showed a SI of 0.034 seconds, concluding that incongruent conditions do result

in slightly slower reaction times (RT) proving the Stroop effect. The error statistics did not reflect the same result but was speculated to be a product of an experimental design error where the word/color balance was off.

Separating the results into the glare-sensitive (n = 6) and glare-insensitive (n = 10) groups, Stroop interferences was found to be 0.034 seconds and 0.024 seconds respectively. Generally, glare-sensitives did show a slower RT for all glare sources than glare-insensitives. The results again agreed with the study by Rodriguez et al. [16] although the number of participants were fewer and the groups were unbalanced in this experiment. It did however suggest that glare-sensitives are more impaired by discomfort glare than glare-insensitive, a fairly open conclusion to RQ3. Again, the error statistics did not reflect the same results as RT.

Separating the results further into both participant groups and glare source placement helped assess the data in regard to RQ2, where in the visual field discomfort glare influences task performance the most. Looking at the data in table 2, the first observation is that the participants generally were quicker than those in the study by Rodriguez et al. [16] indicated by a smaller mean Stroop interference for all sources.

The second observation is that the benchmark values are the highest values for both groups. The benchmark tests had no glare sources switched on and was expected to have the lowest value, since no extra stimulus was introduced other than the Stroop task itself. This defeats the purpose of the benchmark value since this was the value which could prove an influence by discomfort glare, thereby making it impossible for the experiment to answer RQ1. This was speculated to be a product of poor experimental design since both of the benchmark rounds were planned at the beginning of every

	Glare-sensitives (n = 6)		Glare-insensitives (n = 10)	
	Mean Stroop Interference (s)	Rank (#)	Mean Stroop Interference (s)	Rank (#)
Benchmark	0.070	-	0.056	-
Left Bottom	0.047	4/5	0.031	1/2
Left Middle	0.060	2	0.023	4
Left Top	0.043	6	0.020	6
Centre	0.041	7	0.031	1/2
Right Top	0.064	1	0.024	3
Right Middle	0.048	3	0.016	7
Right Bottom	0.047	4/5	0.022	5
Glare source mean	0.050	-	0.024	-
Rodriguez et al. [16]	0.088	-	0.071	-

**Table 2:** Stroop interference (SI) between self-reported glare-sensitives and self-reported glare insensitives. Red color indicates the two maximum SI values for each group

experiment acting as trial rounds for the participants.

The third observation is that it is difficult to point out any specific glare source placement as having more influence than others. The two sources with that largest mean Stroop interference are ranked #1 and #2 (marked with red) in table 2 and the two participant groups do not agree on any of them. Additionally, the differences in mean Stroop interferences are quite small and taking the small sample sizes into consideration, it becomes impossible to conclude anything. Because of this, the answer to RQ2 is inconclusive as it was with RQ1.

## Discussion

The development and construction of the experiment met various challenges along the way. Some were limitations of resources available to the experiment, some were experimental design flaws, and some challenges occurred during the critical week of running the experiment. In hindsight and post-research, some parts of the experimental design could clearly be improved.

### Unbalanced luminance output

The construction of the whole experimental setup ended up

a little behind schedule and a few shortcuts were taken in the construction and installation of the glare source boxes. Measures were taken to minimize voltage loss through electrical cables by using equal cable lengths and thicker gauges of wire. The risk of flicker was minimized by using constant current (CC) regulators for dimming. Manual toggle switches were used together with one single power source, so all LED strips received the same as long as only one box was switched on at a time. All these measures were important to achieve equal luminance output, but the installation of LED strips and aluminum foil inside the boxes were unequal due to the time pressure. In future experiments, equal care should be given to every step in this process. Additionally, with access to more lighting equipment it would have been possible to achieve a more uniform background luminance on surfaces than what was possible in this experiment.

### Misplacement of glare sources

The two top glare sources in the side wall screens were misplaced by 10° angular distance as a construction error. This meant they did not follow the specific borderline of comfort and discomfort (BCD curve) as mapped by Kim & Kim [12,13]. The results did not seem to reflect

the construction error and it could be argued that since the head of the participants were not fixed in position, this level of attention to detail and accuracy did not matter much. Fixing the head position would provide a more fixed variable, but it would also make the 30 minutes more uncomfortable before discomfort glare is introduced also. It is was trade-off to make a more appealing experiment to participate in.

### Manual ON/OFF order

The order in which the glare sources was switched on and off was important to avoid an order bias where a glare source would always be the last in line when the participant is most cognitively fatigued. In this experiment, the experimenter would randomize the order on the go, but would accidentally hit the same spot in the order from time to time. The order of both runs for all 16 participants were analyzed and the perfect order was devised for future experiments using this setup. This perfect order would make sure every spot would be shifted at least 3 spots from the previous run.

### Benchmark tests

As mentioned, the benchmark tests proved a failure. Instead of having both benchmark rounds at the beginning, more rounds could be introduced and spread out throughout the 30 minutes. As an example, two rounds could be put at the beginning and end of each run. This can help answer RQ6, if an influence can be measured or not.

### Unbalanced Stroop task

The Stroop task ended up with an unbalanced word and color count. Of the 78 words presented on screen each round in random order, 39 words would be "RED", 26 would be "GREEN", and 13 would be "BLUE". Of the 78 words, 13 would be written in red color, 26 in green color, and 39 in blue color. As examples, this meant that "RED" written in blue would appear the

most, while "BLUE" written in red would appear the least. This error was pointed out by several participants and can be attributed to the researcher being unskilled in the program used to create the custom Stroop task (PsychoPy). Ideally there should have been a 50-50 ratio of congruent and incongruent conditions, which it was, but the colors and words were not equally presented, which could have an effect on which error statistics.

### Stroop task design

After the experiment and analysis of the results it was necessary to investigate the Stroop task further. It turned out to be difficult to settle what a standard Stroop interference for a normal person was, providing no useful benchmark value from the literature. During this post-research, it became clear that psychologists are not in agreement on how to design the Stroop task themselves, and usually they do not introduce an external stimulus beside the Stroop task itself.

Two studies [17,18] investigated the how the design of a Stroop task can influence the results and tested different variables in the design. The classic version is presented on paper and the methodology and analysis of the data are different from the modern digital version. It has proven difficult to replicate the results and conclusions from the classic version with the modern version. Additionally, how the text is presented and what type of text is presented was also shown to vary the results. The study by Salo & Robertson [17] provides reaction times (RT) to compare against, and they were similar to the RTs in this experiment. They study did not introduce a different stimulus, other than the Stroop task, so it might be suggested that discomfort glare is not causing an impairment in this experiment, answering RQ1 and RQ2 by comparison. This also questions whether the Stroop task is a suitable method of measuring selective attention when a different external stimulus is introduced

other than the task itself, since psychologist cannot fully agree on how it should be designed. In the study by Scarpina & Tagini [18], they called for a standardization of the test and scoring methods to solve this dilemma of not being able to compare results when tests use different methods.

### Conclusion

The literature review revealed the complexity of the human visual system. The sense of vision is relied heavily upon by normal people despite seemingly running as a background activity in the brain. If something is out of focus or straining to the eyes, we can often just squint our eyes to see more clearly, but we do rarely pay attention to the impairing causes. This is often the case with discomfort glare and why it can be a difficult topic to research. Most people have a sense of what lighting environment they prefer, but it can be argued that visual preference is highly contextual, introducing many extra variables to account for in a lab setting. Studies on visual preference require large sample sizes and thorough documentation of context, often in practical settings, in order to form relatively precise conclusions.

This experiment attempted to circumvent participant assessments of discomfort glare with a relatively unproven test method. By using a psychological test of performance, called the Stroop task, to measure selective attention it was hypothesized that it was possible to measure if participants were distracted by sources of discomfort glare from different angles within the periphery of their visual field. The experiment was unsuccessful in determining whether discomfort glare had an influence on performance and if glare from below the line of sight is more impairing than from above the line of sight. It did, however, discuss many important questions in regard to experiment methodology and why discomfort glare is rather complex to research, that future

studies might find interesting. Although suggesting that the Stroop task might not be a suitable method to avoid participant assessments, other methods might still be able to,

but it is possible they involve more complex approaches such as analyzing the centers of the brain responsible for processing the visual information. The literature

suggested more research into topics such as receptive fields [2] and low- and high-spatial frequency contrast sensitivity [3]. ■

### Acknowledgements

The article is based on the master thesis from Mårbjerg, M. K., "Peripheral discomfort glare and its influence on task performance on display screen equipment" (2019). The author wants to thank supervisor Henrik Clausen for his support with the master thesis project from the lighting design educational program at Aalborg University Copenhagen.

### References

- [1] Remington, L. A. (2012). "Clinical Anatomy and Physiology of the Visual System", book (3rd edition). St. Louis, Missouri, USA: Butterworth Heinemann (Elsevier Inc.). ISBN: 978-1-4377-1926-0.
- [2] Scheir, G. H., Donners, M., Geerdinck, L. M., Vissenberg, M. C. J. M., Hanselaer, P., & Ryckaert, W. R. (2018). "A psychophysical model for visual discomfort based on receptive fields", *Lighting Research & Technology*, Vol. 50(2), (205-217). Retrieved from Sage Publishing/Journals January 7th (2019), from <https://journals.sagepub.com/doi/full/10.1177/1477153516660606>.
- [3] Boyce, P. R., & Wilkins, A. (2018). "Visual discomfort indoors", *Lighting Research & Technology*, Vol. 50(1), (98-114). Retrieved from Sage Publishing February 2nd (2019), from <https://journals.sagepub.com/doi/full/10.1177/1477153517736467>.
- [4] Boyce, P. R. (2014). "Human Factors in Lighting", book (3rd edition), Boca Raton, Florida, USA: CRC Press (Taylor & Francis Group). ISBN: 978-1-4398-7489-9 (e-book - PDF).
- [5] Tregenza, P., & Loe, D. (2014). "The Design of Lighting", book (2nd edition). Abingdon, Great Britain: Routledge (Taylor & Francis Group). ISBN: 978-0-415-52246-5.
- [6] Kent, M. G., Fotios, S., & Altomonte, S. (2018). "An Experimental Study on the Effect of Visual Task on Discomfort Due to Peripheral Glare", *LEUKOS - The Journal of the Illuminating Engineering Society*, Vol. 15(1), (17-28). Retrieved from Taylor & Francis Online January 19th (2019), from <https://www.tandfonline.com/doi/full/10.1080/15502724.2018.1489282>.
- [7] Luckiesh, M., & Guth, S. K. (1949). "Brightness in Visual Field at Borderline Between Comfort and Discomfort (BCD)", *Illuminating Engineering*, Vol. 44(11), (650-670). Retrieved February 22nd (2019), from [https://www.brikbases.org/sites/default/files/ies\\_035\\_0.pdf](https://www.brikbases.org/sites/default/files/ies_035_0.pdf).
- [8] Petherbridge, P., & Hopkinson, R. G. (1950). "Discomfort Glare and the Lighting of Buildings". *Transactions of the Illuminating Engineering Society*, Vol. 15(2), (39-79). Retrieved from Sage Publishing/Journals February 24th (2019), from <https://journals.sagepub.com/doi/pdf/10.1177/147715355001500201>.
- [9] Bay, A., Nielsen, E. L., Fontoynt, M., Lumbye, A., Osterhaus, W., Kessler, L. (2017). "Glare and Energy for Lighting", *El-Forsk research project (number 348-009)*. Retrieved from El-Forsk February 22nd, from <https://elforsk.dk/projekt/database/energieffektivt-lys-gennem-blaendingskontrol>
- [10] Einhorn, H. D. (1979). "Discomfort glare: a formula to bridge differences", *Lighting Research & Technology*, Vol. 11(2), (90-94). Retrieved from Sage Publishing/Journals February 22nd (2019), from <https://journals.sagepub.com/doi/pdf/10.1177/14771535790110020401>.
- [11] Iwata, T., & Tokura, M. (1997). "Position Index for a glare source located below the line of vision", *International Journal of Lighting Research and Technology*, Vol. 29(3), (172-178). Retrieved from Sage Publishing/Journals February 10th (2019), from <https://journals.sagepub.com/doi/pdf/10.1177/14771535970290030801>.
- [12] Kim, W., Kim, J. T. (2010a). "A distribution chart of glare sensation over the whole visual field", *Building and Environment*, Vol. 45(4), (922-928). Retrieved from Elsevier Science Direct February 14th (2019), from <https://www.sciencedirect.com/science/article/abs/pii/S036013230900256X>.
- [13] Kim, W., Kim, J. T. (2011b). "A Position Index Formula for Evaluation of Glare Source in the Visual Field", *Indoor Built Environment*, 20(1), (47-53). Retrieved from Sage Publishing/Journals March 7th (2019), from <https://journals.sagepub.com/doi/pdf/10.1177/1420326X10389267>.
- [14] Logadóttir, A., Christoffersen, J., & Fotios, S. A. (2011a). "Investigating the use of an adjustment task to set the preferred illuminance in a workplace environment", *Lighting Research & Technology*, Vol. 43(4), (403-422). Retrieved from Sage Publishing/Journals January 19th (2019), from <https://journals.sagepub.com/doi/pdf/10.1177/1477153511400971>.
- [15] Logadóttir, A., Fotios, S. A., Christoffersen, J., Hansen, S. S., Corell, D. D., & Dam-Hansen, C. (2011b), "Investigating the Use of an Adjustment Task to Set Preferred Colour of Ambient Illumination", *Color Research and Application*, Vol. 38(1), (46-57). Retrieved from Wiley Online Library January 19th (2019), from <https://onlinelibrary.wiley.com/doi/10.1002/col.20714>.
- [16] Rodriguez, R. G., Garretón, J. A. Y., & Pattini, A. E. (2016). "Glare and cognitive performance in screen work in the presence of sunlight", *Lighting Research & Technology*, Vol. 48(2), (221-238). Retrieved from Sage Publishing/Journals February 22nd (2019), from <https://journals.sagepub.com/doi/full/10.1177/1477153515577851>.
- [17] Salo, R., Henik, A., & Robertson, L. C. (2001). "Interpreting Stroop Interference: An Analysis of Differences Between Task Versions", *Neuropsychology*, Vol 15(4), (462-471). Retrieved from American Psychological Association PsycNET May 20th (2019), from <https://psycnet.apa.org/record/2001-05289-005>
- [18] Scarpina, F., & Tagini, S. (2017). "The Stroop color and word test", *Frontiers in Psychology* Vol. 8, article 557. Retrieved from National Center for Biotechnology Information (NCBI) May 13th (2019), from <https://www.ncbi.nlm.nih.gov/pmc/articles/PMC5388755/>



## LED professional Review (LpR) - Annual Subscriptions

### LpR Digital Magazine

- 6 issues
- pdf download
- high resolution pictures and graphs
- printable
- commercial use
- access to all previous issues
- Euro 78.80

### LpR Printed Magazine

- 6 issues
- Euro 158.40

<http://www.led-professional.com/subscription>

## Cover-page

Artwork: Thomas Klobassa,  
©LED professional 2019

Main Images: Arno Grabher-Meyer & Matthias Rhomborg, ©LED professional

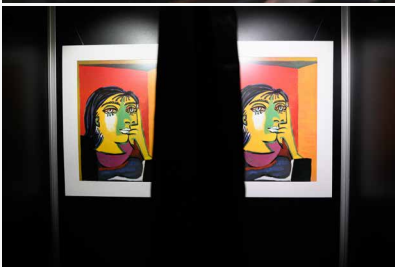

At LpS 2019 - Nordic Power presented a client's track light to demonstrate their "in-track-hidden" LED driver and Nichia highlighted the difference between high quality illumination and standard CRI light

## Next LpR

**DISRUPTIVE TECHNOLOGIES & APPROACHES:**  
Issue 77-Jan/Feb 2020

### TECH-TALKS BREGENZ

Dr. Christoph Waechter,  
Researcher, Fraunhofer IOF

The co-author and presenter of the winning paper of the LpS Scientific Award talks with LED professional about the work at Fraunhofer IOF in general, and the winning paper. He gives background information on the challenge, solution, manufacturing and ideas for future improvement of the approach. ■

### RESEARCH

**"Best Papers" at LpS 2019: Ultrathin Freeform Micro-Optical Elements - The Potential of Tailor-Made Light-Directing Structures on Foil**  
Recent research has shown that free-form (FF) optics can uniquely generate tailor-made radiation patterns or irradiance distributions in a very efficient way while the fabrication of such optics is challenging and costly. The researchers propose to utilize the potential of roll-to-roll UV nanoimprinting technology based freeform micro-optical elements (FF-MOE) on film to master the challenge. ■

### TECHNOLOGIES

**Offline Lighting Voice Controller - An Alternative to Alexa Online**  
The historical evolution of light control by users started with a mechanical switch, followed by potentiometer and dimming, touch panels and touch screens, gesture and movement detection control, and ending today with voice. The latter are mostly online speaker independants like Alexa, Google Home and Siri. But there are privacy and security concerns. The article describes a speaker independent offline voice controls system, explains the technology and discusses pros and cons. ■

### APPLICATIONS

**Simple and Easy Upgrade to a Bluetooth Mesh Smart Home**  
Home automation with and without voice control is in line with the trend. Affordable, simple and reliable solutions are required. The authors present a new solution that sets a new benchmark. A smart terminal that finds its place in a flush mount box to upgrade conventional switches, pushbuttons, or sockets with Bluetooth® (SIG) Mesh. ■

**An Alternative Wireless Controls System Technology**  
Lighting control systems that offer ease of use, scalability and personalization are required for projects like workplace lighting. - Automated connection of devices to each other without limitations to the network size are crucial. The article describes an IoT network solution with its underlying technology and an office lighting application. ■

subject to change

## Imprint

LED professional Review (LpR), ISSN 1993-890X

### Publishing Company

**Luger Research e.U.**  
Institute for Innovation & Technology  
Moosmahdstrasse 30  
A 6850 Dornbirn, Austria / Europe  
phone +43 5572 39 44 89  
fax +43 5572 20 60 70  
info(at)lugerresearch.com  
www.lugerresearch.com

**Publisher**  
Siegfried Luger +43 699 11 33 55 70  
s.luger(at)lugerresearch.com

**Editor-in-Chief**  
Arno Grabher-Meyer +43 699 11 33 55 18  
a.g-m(at)led-professional.com

**Int. Account Manager**  
Theresa Koenig +43 699 11 33 55 20  
theresa.koenig(at)led-professional.com

**MarCom Manager & TiL Editor-in-Chief**  
Sarah Toward +43 699 11 33 55 21  
sarah.toward(at)lugerresearch.com

### Your Sales Contacts

**Int. Sales Manager**  
Victoria Hufmann +49 179 59 69 301  
victoria(at)hufmann.info  
Norbert Hufmann +49 179 59 69 237  
norbert(at)hufmann.info

**China, Hong-Kong**  
Lolo Yeung +852 9732 2081  
lolo(at)castintl.com

**France**  
Brigitte Lindner +43 699 11 33 55 19  
brigitte.lindner(at)lugerresearch.com

**Germany**  
Armin Wezel +49 30 526 891 92  
armin(at)eurokom-media.de

**India**  
Priyanka Rai +91 124 478 7331  
priyanka.ra(at)binarysemantics.com

**South Korea**  
Jung Won Suh +82 2 78 58 222  
sinsegi(at)sinsegi-media.info

**Taiwan**  
Leon Chen +886 2 256 81 786-10  
leon(at)jkmedia.com.tw

**UK, Ireland, Benelux, Scandinavia**  
Zena Coupé +44 1923 85 25 37  
zena(at)expomedia.biz

**US East**  
Karen C Smith-Kernc +1 717 397 7100  
KarenKCS(at)aol.com

**US West & Canada**  
Alan A. Kernc +1 717 397 7100  
AlankCS(at)aol.com

### Copyrights - Luger Research e.U.

The editors make every reasonable effort to verify the information published, but Luger Research e.U. assumes no responsibility for the validity of any manufacturers, non profit organizations or individuals claims or statements.

Luger Research e.U. does not assume and hereby disclaims any liability to any person for any loss or damage caused by errors or omissions in the material contained herein, regardless of whether such errors result from negligence, accident or any other cause whatsoever. You may not copy, reproduce, republish, download, post, broadcast, transmit, make available to the public, or otherwise use LED professional Review (LpR) content without prior written consent from Luger Research e.U. - Institute for Innovation & Technology, Austria. ■



# CONTRIBUTE

## to the LED professional Review

### AUTHOR'S EDITORIAL CALENDAR 2020

ISSUE N°	IN THE SPOTLIGHT**/**	BONUS DISTRIBUTION**	ABSTRACT DUE	ARTICLE DUE	ONLINE PUB.	PRINT PUB.
77 Jan./Feb.	<b>DISRUPTIVE TECHNOLOGIES &amp; APPROACHES</b> Making a profit with lighting products has become harder since the introduction of LEDs as the preferred light source – especially in Europe and the US. Sophisticated new concepts that add value, designs, materials and smart manufacturing methods may provide a chance. This issue reveals the most ingenious approaches.	<ul style="list-style-type: none"> <li>Expo Electronica (Moscow, RU)</li> <li>Light + Building (Frankfurt, GE)</li> </ul>	Oct. 21, 2019	Oct. 28, 2019	Jan. 15, 2020	Feb. 03, 2020
78 Mar./Apr.	<b>TECHNOLOGIES FOR HEALTH &amp; WELL-BEING</b> Efficient lighting has become a prerequisite. Ongoing discussions question whether efficient lighting is also healthy lighting and if it supports well-being. This issue allows for an open discussion about the requirements for healthy light and the presentation of technologies and approaches needed to produce healthy light.	<ul style="list-style-type: none"> <li>Lightfair International (Philadelphia, USA)</li> </ul>	Dec. 16, 2019	Jan. 07, 2020	Mar. 16, 2020	April 01, 2020
79 May./Jun.	<b>FUTURE PROOF SYSTEMS &amp; SOLUTIONS</b> Buildings are usually constructed to last several decades. Therefore owners and operators expect future proof lighting solutions. Uncertainty about future proof lighting products is rises with the number of increasing competitors and the number of systems. Solutions for this issue will be provided in LpR 79.	<ul style="list-style-type: none"> <li>Int. LED &amp; OLED Expo (Kyntex, KR)</li> <li>GZ Int. Lightfair (Guangzouh, CN)</li> </ul>	Feb. 24, 2020	Mar. 02, 2020	May 15, 2020	June 02, 2020
80 Jul./Aug.	<b>ENVIRONMENTALLY FRIENDLY, LASTING DESIGNS &amp; APPROACHES</b> The problem of excessive Artificial Light at Night (ALAN) is a widely recognized phenomenon that is being discussed. The EU Commission supports the move towards a more circular economy to reduce waste. Technologies, designs and solutions that identify these aspects are addressed in this issue.	<ul style="list-style-type: none"> <li>IstanbulLight (Istanbul, TR)</li> </ul>	April 24, 2020	May 04, 2020	July 15, 2020	Aug. 03, 2020
81 Sept./Oct.	<b>TECHNOLOGIES FOR VISUAL PERFORMANCE &amp; COGNITION</b> The EU Commission supports the move towards a more circular economy. Additionally, research demonstrates that artificial light may negatively affect the environment. Technologies, designs and solutions that recognize these two aspects are addressed in this issue.	<ul style="list-style-type: none"> <li>LpS/TIL 2017 (Bregenz, AT)</li> <li>HK Lightfair Aut. Ed. (Hong Kong, HK)</li> </ul>	June 22, 2020	July 06, 2020	Sept. 01, 2020	Sept. 22, 2020
82 Nov./Dec.	<b>TECHNOLOGIES FOR SPECIAL TASKS &amp; APPLICATIONS</b> LED Light is not only used for illuminating rooms and open spaces. The applications of LEDs are manifold. In addition to use in general lighting, this issue acknowledges the importance of LED light sources in automotive, horticultural, medicinal, cosmetic, and environmental applications, including sensing tasks, to name just a few.	<ul style="list-style-type: none"> <li>Lighting Days (Lyon, FR)</li> </ul>	Aug 17, 2020	Aug 24, 2020	Nov. 16, 2020	Dec. 01, 2020

# INFRARED DREAM TEAM.



#INFRAREDDREAMTEAM

*WE speed up  
the future*

## Infrared Dream Team

The infrared emitters and photodetectors from Würth Elektronik ensure perfect optical coupling and extremely fast switching times. Provided in all industry standard packages. Optimize your sensing applications, data transfer or detection uses. Available ex stock. Samples free of charge.

- Perfect optical coupling
- Fast switching times
- Wavelengths: 850 & 940 nm
- With/without daylight filter

For further information, please visit: [www.we-online.com/infrared](http://www.we-online.com/infrared)

