

*The technology of tomorrow for general lighting applications.*

September 2007 | Issue

03

free version  
low resolution  
not printable

Vertical Light  
Emitting Diodes

Analog control  
technologies

True color sensors

# Solutions

## One lamp or a thousand LEDs

Flashlight, general lighting, traffic lights or jumbo color displays.

The answer's always the same:

Total lighting control solutions from STMicroelectronics

### Flash YOUR LEDs

Most advanced Flash Driver STCF03:

Dual mode buck-boost dc/dc converter

1.8 MHz PWM control scheme

Operating input voltage from 2.7 to 5.5V

Flash mode: up to 800mA

Torch mode: up to 200mA

Flash and torch exponential dimming

Flash intensity and duration programmable by I<sup>2</sup>C™

Part number	Topology	I <sub>out</sub>	Efficiency
STCF03	Buck – Boost	800mA	92%
STCF02	Buck – Boost	600mA	90%
STCF01	Boost	300mA	90%

### Display YOUR LEDs

Features of the STPxxCP/DP05 Power Logic family

4, 8, 16 channels, output currents are set by only one resistor

Wide Current range from 5mA to 500mA per output channel

Serial data and clock re-synchronized device by device

VDD 3.3 or 5 V

Derivatives with error detection or auto power saving.

Part number	Description	I <sub>out</sub>	Precision Channel/ Chip
STP04CM596	4 channels	500mA	±1% / ±6%
STP08/16CP05	8/16-channels	100mA	±1.5% / ±5%
STP08/16DP05	8/16-ch with error detection	100mA	±1.5% / ±5%
STP16CPS05	16-ch with auto power saving	100mA	±1.5% / ±5%

Part number	Description	I <sub>out</sub>	VDD
L6902D	250kHz, Step-down with integrated current control	1A	8-36V
L5970D	250kHz, Step-down	1A	4.4-36V
L5970AD	500kHz, Step-down	1A	4.4-36V
L5973AD	500kHz, Step-down	1.5A	4-36V
L5973D	250kHz, Step-down	2A	4-36V

### Power YOUR LEDs

Monolithic DC/DC converters

Operating input voltage from 4V to 36V

Up to 2A DC output current

Internal current limit

Inhibit for zero current consumption

Integrated current control (L6902D)



## Energy efficiency LEaDs the way



Saving energy helps to maintain a healthy environment while reducing the energy costs. The energy is often derived from power plants which burn fossil fuel causes air pollution and contributes to smog, acid rain, respiratory diseases and global warming. Against the backdrop of the finite nature of natural resources and in order to live up to its own high standards, e.g. the Zumtobel Group has awarded projects for Sustainability and Humanity in the Built Environment in mid September 2007.

Shortly, Gerard Kleisterlee, President and CEO of Philips said in a letter to employees: „We believe that big changes start small and that every one of us should contribute to saving our planet. What's more, we are convinced that those companies that combine the principles of economic growth and environmental

stewardship will be the winners of the future and offer long term rewards to you, our employees, and to our customers, partners and shareholders" (ann.: Philips sets target to double sales from green products to 30% of total revenue within five years).

According to an International Energy Agency report, electrical lighting globally consumes approximately 20% of electricity produced. More than 60% of this artificial light is generated by fluorescent tubes today.

Competing with fluorescent lighting systems (especially CFLs) is a challenge when developing LED based general lighting solutions, considering the efficiency contributions of all components involved.

One successful approach to increase the efficacy on LED component level is the vertical LED structure with chemical etched top surfaces roughening. But there are still junction temperature and phosphor (CRI) dependencies which have to be taken into consideration for a real life application (for LED efficacy deteriorations see comparison of 22 products from 10 manufacturers in this issue).

Hence improved cooling systems, optimized phosphors with optics and intelligent driving concepts are needed to overcome the undesirable effects. Shortly linear controlled LED controlling ICs came up to the market which may reduce the complexity and hence the costs of the electronic parts, integrated into highly efficient off-line and battery driven converter stages.

With the September issue of the LED professional Review (LpR) a lot of efficiency topics are covered in depth. System energy efficiency is only one aspect in the lighting domain, but it's one of the most valuable factors - leading us the way.

Please send us your feedback about the LpR content. We would like to get your opinion on how to continuously improve our services to you. Furthermore take the opportunity for your own contribution as well.

Yours Sincerely,

A handwritten signature in black ink, appearing to be 'S. Luger', written over a light blue horizontal line.

Siegfried Luger

Editor

### **Copyrights – Luger Research**

The editors make every reasonable effort to verify the information published, but Luger Research assumes no responsibility for the validity of any manufacturers, non profit organisations or individuals claims or statements. Luger Research does not assume and hereby disclaims any liability to any person for any loss or damage caused by errors or omissions in the material contained herein, regardless of whether such errors result from negligence, accident or any other cause whatsoever. „You may not copy, reproduce, republish, download, post, broadcast, transmit, make available to the public, or otherwise use of LED professional Review (LpR) content without the prior written permission from Luger Research – Institute for Innovation & Technology, Austria.“ ■

## Imprint

LED professional Review (LpR)

ISSN 1993-890X

### Publisher

Luger Research

Institute for Innovation & Technology

dep LED professional

Rhombergs Fabrik

A 6850 Dornbirn, Austria / Europe

phone +43 5572 394 489

fax +43 5572 394 698

editors@led-professional.com

www.led-professional.com

### Publishing Editors

Siegfried Luger, EMBE

Arno-Grabher Meyer

Jasmine Leger, Dr.

### Creative Direction

Thomas Ehgartner | DesignLab

Königshofstraße 47, 6800 Feldkirch

phone +43 5522 60000

office@ehgartner.eu

www.designlab.at



### LED professional Review (LpR) – Subscription

#### LpR Digital Magazine – free version

- pdf download
- low resolution, not printable
- private user

#### LpR Digital Magazine – full version annual subscription

- pdf download
- pictures and graphs in high resolutions, printable
- 6 issues
- commercial use
- Euro 78.80

#### LpR Printed Magazine – annual subscription

- 6 issues
- Euro 158,40

#### Send E-mail to:

editors@led-professional.com

#### LpR Issue – November 2007

- Thermal Management
- Application report
- Drivers
- LED Technology

# Content

<b>Editorial</b>	p 1
<b>Imprint</b>	p 3
<b>Project News</b>	p 5
<b>Product News</b>	p 6
<b>Research News</b>	p 10

## ■ Applications

### **LED Luminaries for General Illumination**

by Dr. Wilfried Pohl, Bartenbach Lichtlabor p 11

## ■ Technologies

### **LED Data Sheet comparison**

by Arno Grabher-Meyer, LED professional p 14

### **Light Extraction Boosts Efficiency of Vertical Light Emitting Diodes on Metal Alloy Substrate**

by SemiLEDs Corp p 24

## ■ Drivers

### **How linear LED driver IC's can make it irresistible to replace resistor biasing**

by Joachim Glaeser, Hakan Yilmazer, Infineon Technologies AG p 28

### **Next Generation LED Area Lighting**

by Bernie Weir and Frank Cathell, ON Semiconductor p 32

### **Innovative Analog Control Technologies for Mainstream LED Lighting Market**

by Andy Aaron and Jeanette Jackson, Light-Based Technologies Inc. p 36

### **Solving high-voltage off-line HB-LED constant-current control-circuit issues**

by Giovanni Carraro, International Rectifier p 41

## ■ Sensors

### **Improved LED systems with true color sensors**

by DI (FH) Fredrik Hailer, MAZeT GmbH p 45

## ■ Trends of Engineering System Evolution

### **Ideality**

by Siegfried Luger, LED professional p 52

## Advertising Index

STMicroelectronics	p C2
Tridonic	p 2
Everlight	p 23
Microchip	p 31
Power Vector	p 35
LED China 2008	p 44
Instrument Systems	p 41
Light-Based Technologies	p 41
Jencolor	p 51
Infineon	p C3
International Rectifier	p C4

## Project News

# Power Vector, Winona Lighting, i2Systems, and Pharos Architectural Controls light up Ballroom



Bartle Hall Convention Center

The Grand Ballroom of the new Bartle Hall Convention Center in Kansas City, MO features a new color-changing LED lighting system powered by Power Vector and lit by Winona Lighting and i2Systems.



Light scene in Bartle Hall's Ballroom

The ballroom is approximately 46,450 square feet and is ideal for concerts, award ceremonies etc. Winona Lighting chose Power Vector's IRIS LED Driver Dimmer™ for their "3-in-1" solution that includes power isolation, DMX 512A interface, and programmable current drivers. The IRIS units were daisy chained together and interfaced to V-Line Gen2-Color fixtures as part of a networked solid-state lighting system. The Pharos Lighting Playback Controller provides decorative lighting effects around the perimeter walls and ceiling of the Grand Ballroom.

### IRIS LED Driver Dimmer™:

Power Vector's three-in-one IRIS LED Driver Dimmer™ is designed for powering and controlling high-brightness LEDs incorporating POWER ISOLATION, DMX 512A, and up to 8 configurable CONSTANT CURRENT drivers into one compact module.

### V-Line Gen2-Color fixtures:

The V-Line Gen2 is a robust and high performance luminaire designed for wall grazing, wall washing and general illumination.

### Pharos Lighting Playback Controllers:

The Pharos Lighting Playback Controllers (LPC) are intended to be price-competitive with frame-store solutions but offer genuine lighting control functionality. Lighting is programmed on timelines with a particular timeline having control data for one, some or all the lighting fixtures being controlled. Multiple timelines are supported and so a single unit can control multiple distinct zones, or more complex presentations can be programmed with external triggers coming from multiple systems. ■

## Product News

# Seoul Semiconductor's Unveils World's Highest Brightness Single LED at 420 Lumens

Seoul Semiconductor (KOSDAQ; 046890), the eighth-largest LED manufacturer in the world, announced that its R&D team has achieved the industry's highest brightness single LED at 400 lumens. Seoul Semiconductor's high performance LED is significantly brighter than conventional single LED which can only emit up to 100 lumens. Seoul Semiconductor's high performance LED is the next-generation lighting source and is expected to accelerate the conversion of conventional lighting to LEDs.



*New high-performance single LED with 420 lumens (left) and SSC Z-power P4 (right)*

The higher brightness and successful miniaturization of Seoul Semiconductor's latest LED technology translates to substantial cost savings for customers. Seoul Semiconductor's single package product emitting up to 420 lumens at 600 mA at maximum and 350 lumens at average, is the world highest brightness among conventional LEDs at the level of 8 watt. The size is ultra slim, similar to that of a single LED package emitting 100 lumens. In addition, the brightness of Seoul Semiconductor's new product at 420 lumens is comparable to that of more than four conventional LEDs. The new LED technology's ultra-compact size coupled with the higher performance at 420 lumens gives engineers greater design flexibility and substantially lowers the cost of the application. By contrast conventional LED severely limits the design options available to engineers as more units are required to attain the same level performance.

"The competition in the LED industry is heating up as customers increasingly demand brighter and smaller products," said Yanghee Han, vice president of sales and marketing at Seoul Semiconductor. "Seoul

Semiconductor's high performance LED technology at 420 lumens enables the company to not only satisfy the high expectations of the marketplace but it also opens up a new market where conventional LEDs are excluded due to its inherent performance limitations."

Seoul Semiconductor has been able to concurrently achieve technology capable of delivering higher performance at a more compact architecture. This milestone is a result of Seoul Semiconductor's consistent investment in research and development, and focus and commitment to position itself as a world leading LED manufacturer. Seoul Semiconductor is already the leading LED manufacturer in South Korea.

Seoul Semiconductor's high performance LED can be used for universal applications such as general residential lighting, automotive headlights, architectural lighting, headlight for task, streetlight, torch lighting, camping lighting, and signage lighting.

The higher performance, compact architecture and cost advantages afforded by Seoul Semiconductor's new LED technology will enable the company to penetrate markets that are inaccessible and beyond the reach of conventional LEDs. This suggests that the application area for the technology is unlimited. Seoul Semiconductor is planning to commercialize this new product by the fourth quarter, 2007. ■

## Golden DRAGON® with lens for general lighting



Depending on the lens used, the new Golden DRAGON® from OSRAM Opto Semiconductors is a strong light source for medium or flood beam characteristics with white or colored light. The special feature of this LED is that it makes it much easier to construct luminaires and therefore opens up a much wider range of design options. Minimal dimensions will

inspire luminary designers to create exceptional products for accent lighting or as reading lights that consume only a few watts.

With a 20° or 40° beam characteristic - depending on the lens - the high-power LED is ideal for accent lighting, spotlights, reading lights or desktop lights. Even with their integrated lenses these light sources are less than 1 cm high, giving designers almost unlimited options. The lighting area can be split, with small multiple dots of light inspiring some unusual designs. The available white tones cover the entire spectrum from cold white to warm white. Red, yellow, blue and green Golden DRAGON® LEDs with 20° or 40° lens add to this creative freedom.



Not only are these light sources a designer's dream, they also consume very little energy. A Golden DRAGON® with a 20° lens for example has a typical brightness of 60 lm at an operating current of 350 mA and achieves an efficiency of 54lm/W. The LED achieves a luminous intensity of 155 cd. ■

LED type (350 mA, 1.12 W, 6500K)	Typical brightness (lm)	Typical efficiency (lm/W)	Luminance (cd)	Luminance per watt (cd/W)
Golden DRAGON® 20°	60	54	155	139
Golden DRAGON® 40°	60	54	81	72

## Enfis announces UNO Neutral White Array Exceeds 1,300 lumens from 0.5cm<sup>2</sup>



Enfis Ltd, a global leader in the development and manufacture of smart, multi-watt plug-and-play light engines and arrays, announces that its latest UNO White Array has now achieved an output of over 1,300 lumens of neutral white light. The array produces an output of 1,365

lumens from an emitting area of just 0.5cm<sup>2</sup>, providing a powerful point source that can be easily manipulated optically to provide a range of lighting solutions.

Besides offering the arrays, Enfis will also be integrating the arrays into its range of UNO Light Engines. Uniquely, the Enfis UNO Light Engine is a complete solution with fully integrated electronic and thermal management. By utilizing Enfis' smart array technology, and complete light engine solutions, users can benefit from quality white light from a highly efficient and powerful 'spot source', with the assurance of long-lasting, reliable, superior performance. All this capability comes in a package that is simple to integrate, reducing time-to-market and associated cost and risk. ■

## Schott Glass beats Plastic

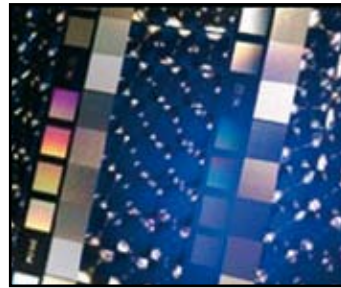

New pressing technique from SCHOTT enables high precision mass production of diffractive optical elements from glass for the first time. Until now, diffractive optical elements for mass production could only be manufactured out of plastic, with all of its known weaknesses,

including high scattering losses, low resistance to temperature, moisture, lasers and chemicals. Now, SCHOTT has come up with an alternative. The international technology group based in Mainz is now manufacturing diffractive optical elements from optical glass. These elements are extremely precise and efficient and can be manufactured in larger quantities using the precision blank molding technique.

One can hardly imagine modern optical systems of lasers, sensors, lighting and imaging devices without diffractive optics. These extremely small elements that diffract the light inside minute spaces and bundle it into beams with exact shapes and direct it in the desired direction represent the key to miniaturization of optical systems. Until now, these elements for serial applications have been manufactured using plastic or fused silica with the help of sophisticated and, therefore, expensive lithography techniques and etching processes.

New diffractive optical elements (DOEs) made from high index glass from SCHOTT feature high diffraction efficiency of up to 95 percent. They also exhibit high mechanical, thermal and chemical durability and make it possible to combine various optical functions inside a single element. DOEs can be produced for use as blazed diffraction grating, computer generated holograms (CGH) and Fresnel zone lenses.

The precision glass molding that is now being used by SCHOTT to produce the DOEs, is at the heart of the unique manufacturing process, it has been used for years to manufacture large aspherical lenses for sensors, cameras and projectors, yet has also proven itself in manufacturing micro lenses.

Now, SCHOTT has succeeded in using the precision molding technique to manufacture diffractive optical elements and pressing the contours of the highly precise shaping tool onto the surfaces of glass thousands of times in an identical manner. "No other company is capable of manufacturing these types of optics with such reproducible precision," notes Helge Vogt, New Products Manager at SCHOTT AG. The new diffractive optical elements are available now. ■

## Gallium Introduces First Downlight Featuring Lumileds Rebel LED



Gallium Lighting announced the introduction of the first commercial LED downlight featuring the Lumileds Rebel LED. The Rebel LED provides an efficacy of up to 91 lumens per watt, which is 20% higher than the most efficient compact fluorescent lamps. Because Rebel LEDs have a hemi-

spherical light distribution, the optical efficiency of an LED downlight is typically higher than a comparable compact fluorescent downlight. Independent Testing Laboratories, Inc recently verified that Gallium's GS6 downlight can deliver more than 1,000 lumens while consuming only 21W, which is almost twice the efficacy of a comparable compact fluorescent downlight.

The Rebel LED also has a rated life of 50,000 hours, which is four times the life of compact fluorescent lamps. When operated during normal business hours, Rebel LEDs have a service life of 25 years.

„Since LEDs contain no mercury, our products have always been greener than compact fluorescent luminaires," said Keith Bahde, Ph.D., President of Gallium Lighting. „With the latest generation of LEDs, we now offer substantial energy savings as well. Coupled with the maintenance cost savings, LED lighting provides an attractive return on investment. LEDs now outperform compact fluorescent in every respect." ■

made from epoxy glass-on-aluminium and is equally easy to process in PCB manufacturing.



*Bond-Ply TCP-1000 - LED Test Card from BERGQUIST.*

Bond-Ply TCP-1000, which comes in the form of a Metal Core PCB, offers superior thermal performance over standard FR4 substrates at a highly competitive price. The aluminium base layer comes in standard thicknesses of 1.0 and 1.6mm whereas the circuit-foil is available in 35 µm and 70µm. Other foil thicknesses are available upon request. Laminated panels are available in 18 x 24-inch as well as 20 x 24-inch sizes. Bergquist also offers circuits that are custom configured to specific design parameters.

Designed specifically to offer an alternative to various FR4 configurations, Bond-Ply TCP-1000, with a thermal conductivity of 1,5W/m-K, has a thermal performance that is at least 3.5 times better, supporting the high performance levels needed for applications with increased lumens per Watt while managing the LED junction temperature effectively. ■

## New cost-effective thermal management material for High Brightness LED applications from Bergquist

Bond-Ply TCP-1000, a new dielectric material from The Bergquist Company, satisfies the extreme thermal challenges of applications using high brightness LEDs (HB-LEDs). Without proper thermal management techniques HB-LEDs quickly warm-up, reducing their light out-put. Life-time is also related directly to the junction temperature, so the selection of a good thermally conductive substrate helps considerably in reducing the risks of over-heating the HB-LED.

Using Bond-Ply TCP-1000 as a circuit board laminate delivers more effective heat transfer from temperature-sensitive components than standard prepreg materials. It competes effectively with constructions

## High-Power, High-Efficiency HB LED Driver with Rapid Current Pulsing

August 29, 2007 - Maxim Integrated Products (NASDAQ: MXIM) introduces the MAX16821 high-power, synchronous high-brightness LED (HB LED) driver that has rapid current pulsing and is the first to drive common-anode LEDs. Its patent-pending, rapid-current-pulsing LED technology meets the demanding requirements of projection applications, thus making it ideal for front-projection, rear-projection TV (RPTV), and pocket-projector applications that require very fast LED dimming capabilities. Additionally, the unique, innovative driver architecture of the MAX16821 allows HB LEDs to be mounted in the common-anode configuration, a necessary requirement for truly

efficient thermal management that reduces system integration and assembly costs.

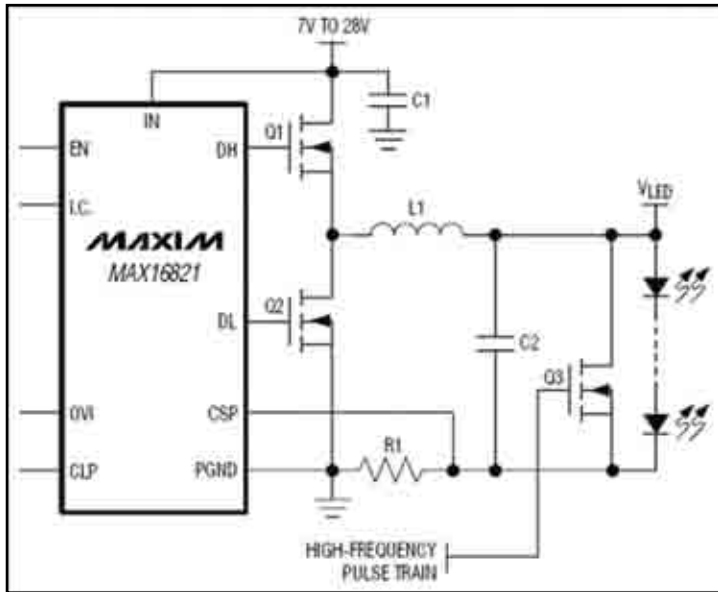

Typical topology with MAX16821 (PATENT PENDING)

#### Key features:

- Up to 30A Output Current
- True-Differential Remote Output Sensing
- Average Current-Mode Control
- 4.75V to 5.5V or 7V to 28V Input-Voltage Range
- 0.1V/0.03V LED Current-Sense Options Maximize Efficiency (MAX16821B/MAX16821C)
- Thermal Shutdown
- Nonlatching Output Overvoltage Protection
- Low-Side Buck Mode with or without Synchronous Rectification
- High-Side Buck and Low-Side Boost Mode with or without Synchronous Rectification
- 125kHz to 1.5MHz Programmable/Synchronizable Switching Frequency
- Integrated 4A Gate Drivers
- Clock Output for 180° Out-of-Phase Operation for Second Driver
- -40°C to +125°C Operating Temperature Range

The MAX16821 also features a unique pin configuration capability that allows the device to be operated in either synchronous buck or synchronous boost mode. Synchronous buck and synchronous boost modes allow the LED driver to operate at very high efficiencies, a performance requirement that is particularly important in high-power applications such as automotive exterior lighting and emergency lighting systems.

The wide switching frequency range (125kHz to 1.5MHz) allows small inductors and filter capacitors to be used in applications such as pocket projectors where system designers are faced with extremely tight space constraints. For systems requiring multiple drivers, the MAX16821 also features a clock output with 180° phase delay that can control a second, out-of-phase LED driver. This feature can be used to minimize LED current ripple, thereby reducing the size and cost of the input and output filter capacitors even further.

The highly integrated MAX16821 operates from 5.4V to 28V with an LED current-sense voltage of 0.03V, providing the lowest dissipation of power. (Other current-sense voltage versions are also available.) Additional features include programmable hiccup, overvoltage protection, reverse current limit, and an output-enable function. The MAX16821 operates over the automotive temperature range of -40°C to +125°C and is available in a tiny, lead-free, 5mm x 5mm x 0.8mm, 28-pin TQFN package with an exposed pad. ■

## First 3-channel DMX dimmer from OSRAM

With its Optotronic OT RGB DMX dimmer, OSRAM has now entered the world of DMX 3-channel dimmers for LED systems. Since DMX supports up to 512 individually addressable channels, the new dimmer lends itself particularly well to creating effect-oriented lighting in discotheques, theatres or concert halls, as well as to the large-area illumination of architecture.



Optotronic OT RGB DMX DIM

The Optotronic range from OSRAM includes control gear units, dimmers and „all in one“ devices specially designed for use in LED lighting. The new dimmer now makes it possible to integrate LED systems such as OSRAM Linearlight Colormix, Linearlight Colormix Flex or Backlight easily into DMX Digital Multiplex universe. The new dimmer utilises pulse width modulation (PWM) to permit individual colour mixing of

LED modules over the whole dimming range. The connected modules are addressed via the coding switches in the housing cover. Control is accomplished by means of a commercially available DMX controller. Due to its compact, flat dimensions, the dimmer is suited for any – even narrow – installation situation. The integrated strain relief and the covers on both input and control side ensure a safe and independent installation.

The unit meets the requirements of protection class II (protective insulation) and can be used indoors and outdoors in temperatures of -20 to 50°C. Featuring a rated input voltage range of 10 to 24V and low power loss, the dimmer is supplied via an Optotronic control gear unit with a power range of up to 2A per channel. Consequently, one dimmer can, for example, control two four-metre modules of the OSRAM Linearlight Colormix Flex. ■

## Research News

### Philips Lumileds' Lumiramic™ phosphor technology makes luminaire design and manufacture easier

Philips Lumileds shortly introduced a new phosphor technology, Lumiramic, developed jointly by the company's Advanced Laboratories in San Jose and Philips Research in Europe. Lumiramic phosphor technology enables targeted production of white LEDs to specific correlated color temperatures (CCT) on the black-body curve resulting in high volume availability in the most desired color temperatures. Utilizing Lumiramic phosphor technology, Philips Lumileds may reduce the number of fine bins at a given CCT by 75% or more. This will greatly simplify the efforts of the lighting community which has asked the LED industry to reduce the variation in white LEDs and more effectively enable luminaire to luminaire consistency. Eliminating complex binning schemes, ensuring consistent high-volume supplies of white LEDs on the black-body curve, and making it easier than previously imagined to meet future Energy Star guidelines are just some of the efforts Philips Lumileds is undertaking to facilitate and speed the development of never before possible lighting solutions.

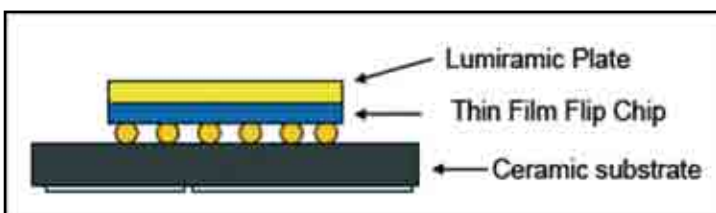

Lumiramic Technology

Lumiramic phosphor technology utilizes a ceramic phosphor plate and the company's new Thin Film Flip Chip (TFFC) technology. TFFC technology, recently introduced in Luxeon Rebel, is the only thin film process that removes the anode and cathode from the light output path and provides an unobstructed plane to which the Lumiramic plate can be applied. This optical alignment is not possible with other thin film technologies. The technology is already being incorporated into the company's LED automotive headlamp products, so that the auto industry's stringent color consistency requirements are met easily and through a completely scalable manufacturing process.

"Philips Lumileds is vertically integrated meaning we develop, manufacture and use our own chip, phosphor and packaging technologies. Thus our scientists and engineering teams have the unique ability to direct our efforts with the intent that advances in one area are not just supported by other technologies, they are designed to work in conjunction with advances in each of the other technology areas," said Frank Steranka, Executive Vice President of Research & Development. "TFFC and Lumiramic are a perfect example of two technology advances that independently provide great value to the market but together, enable an entirely new level of lighting performance. Lumiramic and TFFC were two of the key technologies used to achieve the 115 lm/W performance announced earlier this year and we continue our work on the remaining technologies that will take our performance to these levels and beyond." ■

### Cree Achieves Highest NIST Verified Efficacy from a High-Power LED

Cree, Inc. (Nasdaq: CREE), a leader in LED lighting components, announced it has achieved R&D results of 129 lumens per watt for a cool-white LED and 99 lumens per watt for a warm-white LED. These are the best results reported for packaged, high-power LEDs, and they clearly indicate that Cree is extending its lead in solid-state lighting through its continued investments in LED technology.

The results have been verified by the National Institute of Standards and Technology (NIST). NIST's tests confirmed that the cool-white (5,813 K) LED produced 135.7 lumens of light output and achieved 129 lumens per watt efficacy. The warm-white (2,950 K) LED produced 104.2 lumens of light output and achieved 99 lumens per watt efficacy. The institute tests LEDs at 350 mA and measures the output after five minutes of operation to ensure thermal stabilization. ■

## Applications

# LED Luminaires for General Illumination

> Dr. Wilfried Pohl, Bartenbach Lichtlabor

Light Emitting Diodes (LEDs), in the 1960ies used as small colored indicators with a few milliwatt power and an efficacy less than 0,1lm/W, are now undoubtedly the most revolutionary innovation in lamp technology since decades. Powered meanwhile by several Watts, emitting white light with an efficacy of more than 50lm/W, and with a color rendering index (CRI) greater than 80, they are on the way now to capture the General Illumination market.

The benefits of LEDs are a long lifespan up to 100.000h, color mixing possibility (flexible color temperature Tf), 'cold' spectrum (no infrared), design flexibility and brilliant light due to its small size, easy control and dimming, safety due to low-voltage operation, ruggedness, and a high efficacy (lm/W) compared to incandescent lamps.

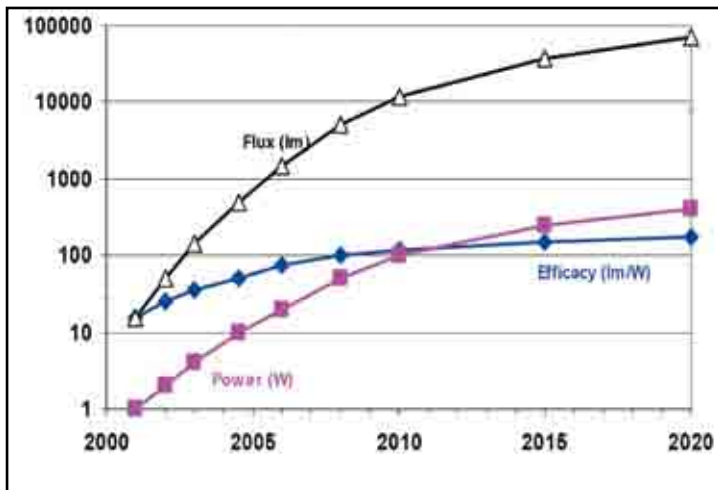

Schematic evolution of white LED performance

## Economics

Due to the low prices and high lumen output fluorescent tubes with an efficacy of >100lm/W and life spans >20.000h are the most economic and wide spread lamps, more than 60% of the artificial light is generated by this lamp type today. Compared to this, LED's are expensive and offer a much lower light output. On the basis of luminary costs the following dimensions result from this:

Lamp type	mean luminary costs (in Euro/Mlmh)
Incandescent, Halogen	10
Fluorescent	1
Metal halide	5
LEDs	20

The gap between conventional light sources and LEDs is decreasing but at the moment still is too large for economical lighting. Only for the GLs-lamp (general light bulb) and the halogen lamp, both incandescent lamps and the most used lamp types in homes, with a very low efficacy (<20lm/W) and life time (<4000h), LEDs are an economic alternative. Up to now the LED general lighting market is mainly focused on 'architectural lighting'.

## Barriers and challenges

Other barriers for mainstream applications are missing industrial standards (holders, controls and ballasts, printed circuit boards, etc.), the required special electronically equipment (drivers, controls), short innovation cycles of LEDs, and special optics rather different from conventional metal fabrication.

The spectral distribution and intensity of the LED radiation depends strongly on its temperature, they are much more sensitive to heat conditions than conventional lamps. It is therefore essential to care for an optimal heat transport to keep the temperature of the solid as low as possible, i.e. a special thermal management is required.

LEDs of one type series have a wide spreading of their radiation features (production tolerances), therefore they are classified in so called binning, i.e. they are graded in different classes regarding luminous flux, dominated wave length and voltage. For applications with high demands on color stability it is necessary to compensate and control these production and operating tolerances by micro controllers to reach predefined color features (spectra's).

All these features and requirements make high demands on the development of a LED-luminary.

## Examples

For Trumpf, a German medical equipment company, a special surgery luminary was developed in the last years. The optics consists of a lens matrix (180 small lenses) which creates a very homogenous spatial light distribution over the surgery's wound, with minimal shadows and an

illuminance of 160.000 Lux. The color temperature is variable from 3000K up to 6000K (with constant illuminance), and the illuminance level and distribution is controllable, thus adjustable to different medical situations and to different daytimes. Due to the 'cold' LED-light (no Infrared) the surgeries are not exposed to any heat radiation which increases the comfort during operation significantly.



TRUMPF 'LED 5' surgical light



LED downlight (combined with halogen lamp for adjustable ambient lighting)

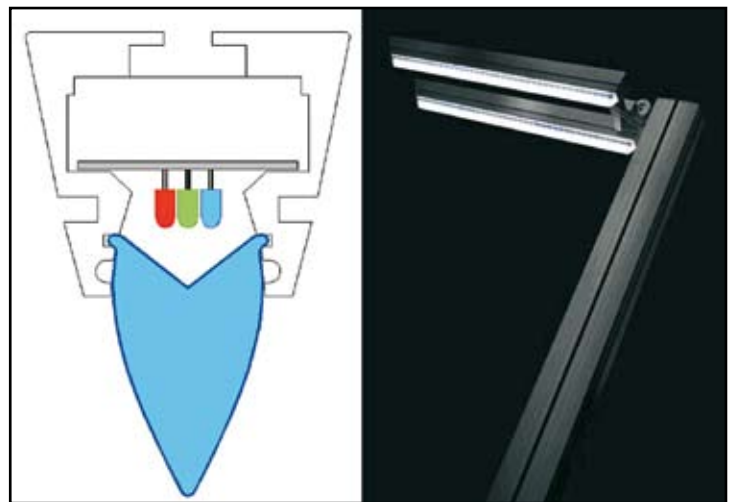

Streetlight HESS 'Millenium' (aspheric lens mixing RGB-LEDs)



LED illuminated conference room at Bartenbach (2000)

## Conventional lamps and future prospects

But what happens with the already used and widespread lamps? The antiquated general light bulb (GLs) will be replaced in the near future by compact fluorescent lamps, halogen lamps and LEDs, and due to their low efficacy (<15lm/W) and life span (1000h) in some countries light bulbs will be forbidden by law.

Fluorescent lamps are the most efficient and economical lamps. This lamp type is very well-engineered and big improvements are not conceivable medium term. The conversion of UV to visible radiation by the phosphors is restricted by quantum laws, and a further breakthrough is not predictable at the moment.

High Intensity Discharge lamps (HID) are the alternative to fluorescent lamps for applications where more light output in smaller volumes is needed. The mostly used type for indoor applications is the metal halide lamp (on a mercury basis, white light with good color rendering, up to 100lm/W), for outdoor applications sodium lamps (very bad color rendering, up to 180lm/W) are also in use. There is a big improvement

potential, and the lamp manufacturers are upgrading HID lamps step by step, and the efficacy of the next generation metal halide lamps will reach 150lm/W.

One of the promising new developments are the OLEDs (organic light emitting diodes), a special type of solid-state light source. Currently used only as flat panel displays, they will be usable in 5-10 years for special architectural applications, providing to architects and designers thin and flexible luminous sheets like 'lighting wallpaper' for ceilings, walls, windows etc.

Electroluminescence (EL) lamps, which can be made in any color, are used for displays, advertising boards and safety signs. Similar to OLEDs, they will hit the lighting market only in special applications.

## Outlook

Following the actual LED performance forecast, white LED lighting will soon outperform most traditional lamps (superior lifetime, decreasing prices, and increasing efficacy) which open the way for LEDs to be the light source of the future with a broad field of applications. LEDs will become a competitive lamp also for economic lighting, but it will not supersede fluorescent and HID lamps. Due to its continuous spectrum, it is the perfect lamp for replacing the general light bulb (GLs) and halogen lamps.

LEDs need to be equipped with special electronics and optics, this will create a whole new industry for LED luminaires. One of the challenges will be the management of the maintenance and life cycles of LED-luminaires to encourage sustainable LED luminaire design.

New findings regarding biological effects (e.g. melatonin suppression) of light and the influence of light on health (e.g. shift working) generate an increasing demand for innovative lighting that gives better control over the color (spectrum), shape, and intensity of light, which creates a huge demand for LEDs applications in general lighting and for luminary manufacturers. ■

## ADVERTISING

### LED professional Review (LpR)– Media Kit 2007

Send Email to:

[editors@led-professional.com](mailto:editors@led-professional.com)

Ref: LpR Media Kit

or call us at: +43 5572 394489

# LED Technology

## LED Data Sheet comparison

> Arno Grabher-Meyer, LED professional

LEDs have made big steps forward during the last years with continuous improvements in efficacy, CRI and reliability. Within datasheets really auspicious values for luminous flux, efficacy and other parameters are highlighted by manufacturers. But why do we see just a low number of really outstanding good LED luminaries that reflect the quality of the improved LEDs? Why is there such a big gap between the LED data and the data of the luminaries? There are numerous reasons. LEDs as illuminant have different design criteria depending on manufacturer and LED type in relation to classical illuminants like halogen lamps or fluorescent lamps. Another reason probably is that datasheets don't reflect real life operation.

The amount of information and data in datasheets of manufacturers is quite different. Sometimes important data are missing, accurate reading of graphs is not easy, and efficacy, lumen output or other parameters are shown at different co-parameters, e.g. while one manufacturer uses a junction temperature of 25°C the other uses 40°C or even uses the pad temperature as reference. Also the reference current for efficacy and lumen output can be different. Often a direct comparison is not possible and a lot of time-consuming calculations are necessary. In some cases datasheets for different products of one and the same manufacturer don't show the same set of data and charts or parametric values are based on different co-parameters. Even at the same test current, the lumen output of different products is not directly comparable because the voltage of the different LEDs at the same current might not be identically. Hence power dissipation of different products varies from less than 1.1 Watts up to more than 1.2 Watts at 350mA; a difference of around 10 to 15%. As a result the LED with a better efficacy value in the datasheet could deliver just the same or even a lower luminous flux in the application.

LED-professional has compared the most recent and most efficient LEDs of leading manufacturers and some low cost LEDs based on their datasheets. Overall 9 cold white, 5 neutral white and 9 warm white products from 10 manufacturers were investigated. Two different scenarios were applied. First scenario is for a spotlight at an ambient temperature of 25°C. Second scenario is for a built in downlight with an equivalent ambient temperature of 50°C.

### Background for the two scenarios

All datasheets values are results of measurements under determined testing-conditions that are not directly linked to real life applications, e.g. the usually propagated junction temperature of 25°C cannot be reached using passive and not sophisticated cooling systems at the very common ambient temperature of 20 to 25°C.

The most important question for customers is how the different LEDs perform under real-life conditions and how big are differences to the nominal datasheet performance. - in praxis useful lumens instead of initial lumens are relevant.

At the first glance parameters of the different products seem to differ not that much.

Because of parameter interactions a clear statement is not possible without calculations, but what assumption should be made?

The chosen scenarios are representing very common applications of today's lighting systems using halogen lamps that should be replaced by LEDs. The scenarios represent completely different thermal conditions. For the spotlight application it's possible to find a design that causes a moderate thermal stress and in contrary for the downlight application one have to expect a high thermal stress for the LED. In both cases we postulated an often used thermal design for MR16 sized lamps with a thermal resistance of 10K/W. MR16 size was taken because LED technology should provide at least the same design options like halogen lights and LEDs should replace incandescent and halogen technology. As consequence we've chosen 25°C and 50°C as (equivalent) ambient temperatures.

### About the investigated products

The investigated LEDs have different packaging types, and different power ranges from a maximum rated power of around 2.5 Watts or a current of 700mA up to 5.5 Watts. Some products are single chip and others multi-chip solutions. Some of the multi-chip solutions are driven in parallel, others in series. The same product type can have other maximum power ratings depending on the color temperature. Usually the neutral white and warm white products can just be driven with a maximum current of 700mA, whereby the cold white counterpart can be driven up to 1000mA. Some LEDs can withstand junction temperatures up to 150°C.

### Which parameters were investigated?

- Efficacy
- Luminous flux
- Junction temperature (Tj)
- Voltage for a given power consumption at different currents, mostly 350mA, 700mA and 1000mA (or maximum allowable current)

### Why choosing these parameters?

Efficacy and luminous flux are two critical key parameters for designing a product that finally should compete with conventional light sources like fluorescent light or MR16 halogen light. Power dissipation at a



defined current and resulting junction temperature are main influence factors.

Efficacy and luminous flux are not linear correlated to driving current. These parameters are also influenced by  $T_j$ . Voltage is depending on  $T_j$  too.

## What about other critical parameters?

For sure there are a lot of additional parameters, which are relevant for lighting designers, lighting planners and architects. These parameters are usually not documented in datasheets quite well. Some of them are also influenced by the driving conditions and  $T_j$ . They just can be compared by time-consuming and expensive measurements. CCT, CRI, homogeneity of color, accuracy of light distribution (Lambertian, etc.) are so important that the results of this investigation shall not be taken to judge product quality, but to sensitize for these facts and the complexity of the topic.

## What was the systematic approach for the analysis?

For the analysis of the graphs from the datasheets we assumed that just one parameter was changed and all other parameters were held constant.

Most calculations started from the nominal values of the datasheet and if necessary using values that could be extracted from the different graphs.

Luminous flux was taken from the best available binning for the different CCTs. Thereby the mean value was taken.

### Step 1:

- Using nominal current and voltage at the given test temperature power dissipation was calculated.
- Efficacy was calculated by the division of luminous flux by calculated power dissipation for the nominal values.

### Step 2:

- $R_{th}$  from case to air was assumed to be 10°C/W, an often referenced and practicable value for MR16 designs.
- With  $R_{th}$  from junction to case  $T_j$  was calculated for  $T_{Amb}=25^\circ\text{C}$ ,  $T_{Amb}=50^\circ\text{C}$  and  $T_j=25^\circ\text{C}$  (as the most common value in datasheets).
- Voltage at  $T_j$  was calculated using the temperature coefficient of voltage.

- Luminous flux was corrected using given temperature dependent relative luminous output chart.
- Efficacy at  $T_j$  was calculated by division of Luminous flux by power dissipation at  $T_j$ .
- Resulting power dissipation was used to calculate luminous flux.

## Uncertainties and simplifications

As mentioned before, not all datasheets showed clearly defined co-parameters and some data were extracted or calculated from information of additional papers like application notes. Manufacturers claimed measurement tolerances from 6 to 10% for their products, hence also assuming a tolerance of +/-10% for all results.

For simplification the whole power consumption was also taken to calculate heat (power) dissipation and junction temperature

## Result for nominal datasheet values at $T_j = 25^\circ\text{C}$

These results represent the specifications promoted in most advertisements and datasheets. Degradation without influence of temperature can be seen.

General behavior for all CCTs is identical: Ambient temperature must be unrealistic low depending on the driving current respectively used power - for one Watt  $10^\circ\text{C}$  to below  $-40^\circ\text{C}$  at five Watts.

### CCT=6000K (blue diagrams):

The three most efficient products also show good thermal performance. To achieve 230 to 240 lumens using 3.4 to 3.8 Watts and to hold junction temperature at  $25^\circ\text{C}$  the ambient temperature has to be below  $-12^\circ\text{C}$  to  $-20^\circ\text{C}$ .

At the other end a LED, just rated for 700mA with lower efficacy, would need an ambient temperature below  $-38^\circ\text{C}$  for its maximum output of 120 lumens.

The most efficient product with about 100 lumen/Watt at one Watt degrades to below 70 lumen/Watt using 3.5 Watts, still better than the initial efficacy of some other products that e.g. start with 50 lm/Watt and degrade to below 30 lumen/Watt consuming almost 5.5 Watts of power.

### CCT=4000K (yellow diagrams):

All products need around  $5^\circ\text{C}$  consuming one Watt to keep a junction temperature of  $25^\circ\text{C}$ . Products just rated for 700mA maximum current can hold nominal  $T_j$  with less than  $-10^\circ\text{C}$  ambient temperature reaching almost 140 lumens; others can stand up to five Watts, but need more than  $-40^\circ\text{C}$  to perform with 216 lumen.

The least efficient products emit just about 100 lumen by consuming 4 Watts and therefore ambient temperature must stay below  $-30^\circ\text{C}$ .

Efficacy reduction of the nominal most efficient product is from 77 lumen/Watt to 60 lumen/Watt - still better than the least efficient product at nominal 1 Watt.

Efficacy of one product has a relatively small change in efficacy over the whole power range from 58 lumen/Watt at one Watt to 45 lumen/Watt at 5.2 Watts.

### CCT=3000K (orange diagrams):

A bunch of LEDs need a similar ambient temperature for the initial power of one Watt. Most of them need around  $5^\circ\text{C}$  to hold the nominal Junction temperature; one just need  $10^\circ\text{C}$  but another at least  $-8^\circ\text{C}$ .

The situation is comparable to the products with a CCT of 4000K. To drive with high power and to achieve high luminous flux ambient temperature has to stay below  $-40^\circ\text{C}$ .

Again some products perform with a higher efficacy at maximum stress than others at initial 1 Watt power consumption.

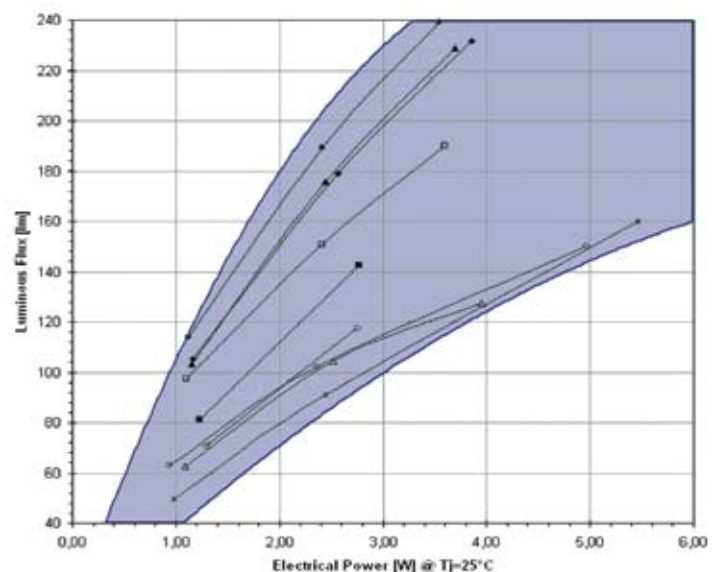
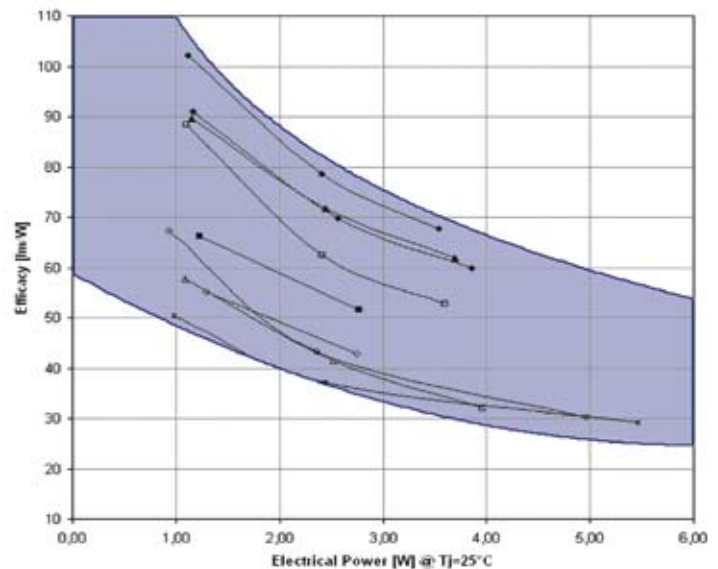
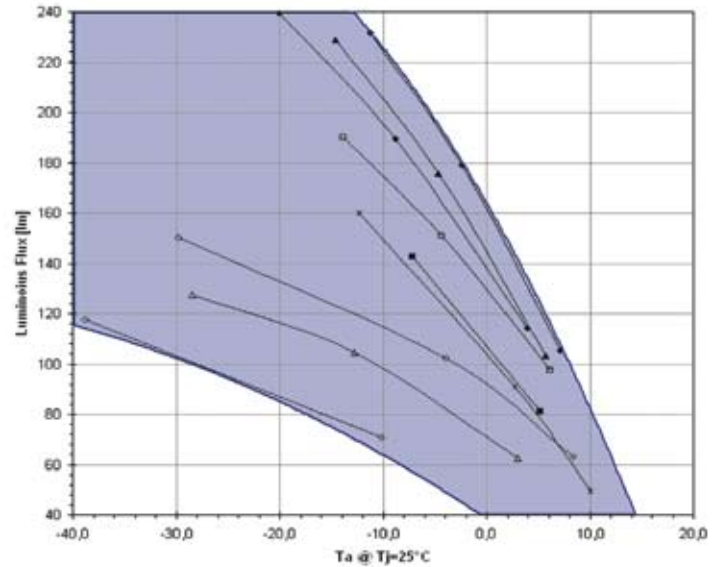

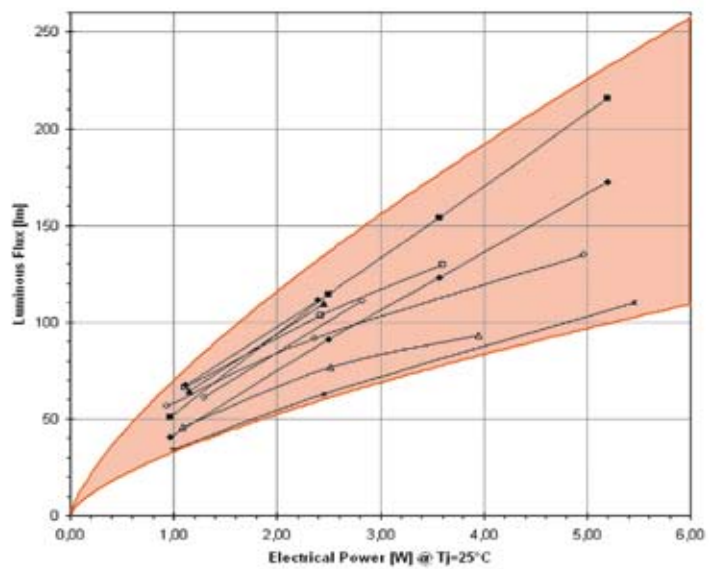
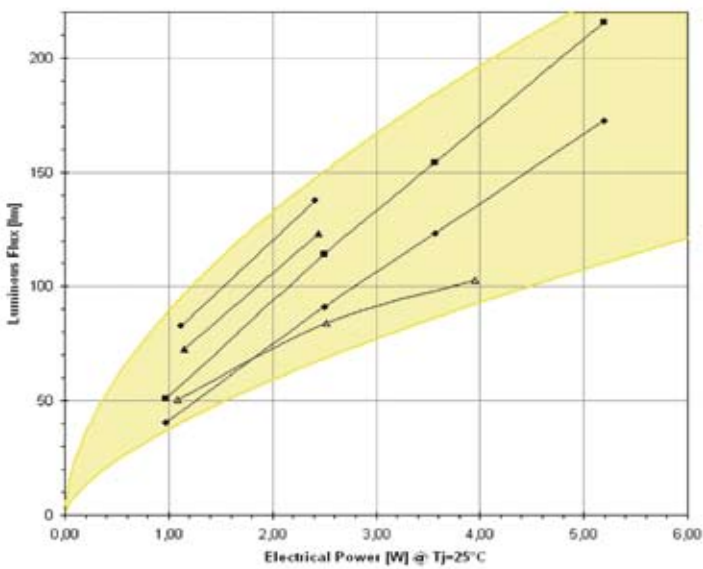
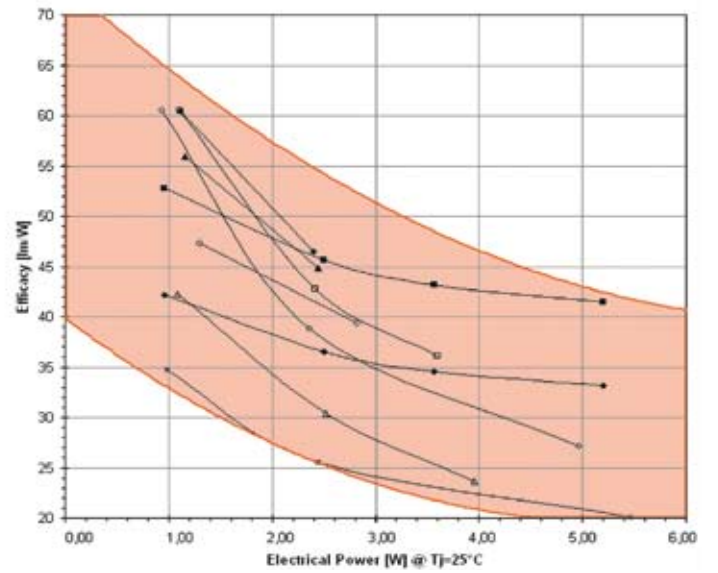
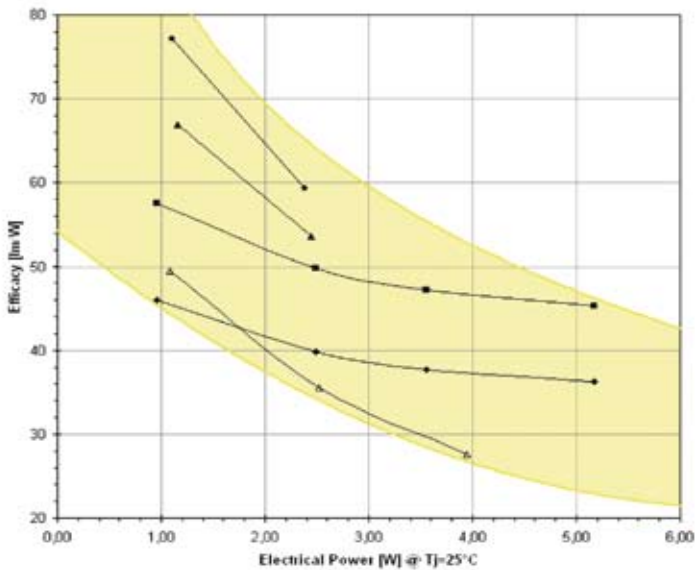
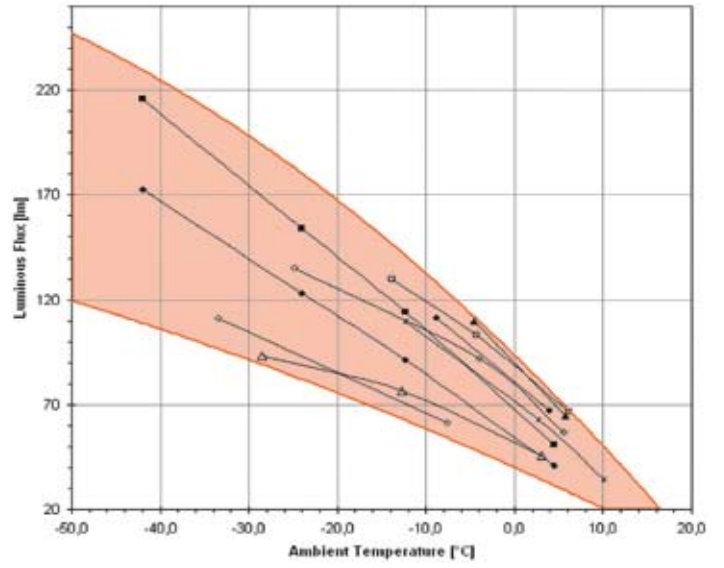
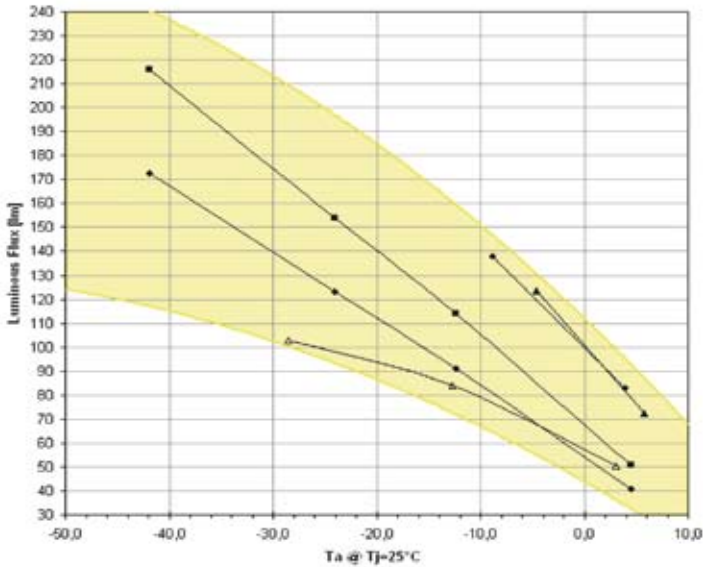

## Calculated result for $T_{Amb} = 25^{\circ}\text{C}$

Most products show acceptable thermal performance with a maximum junction temperature between  $55^{\circ}\text{C}$  and  $70^{\circ}\text{C}$  at 2.5 to 3.7 Watts power consumption. Products with higher rated power consumption of up to 5,5Watts can reach critical  $90^{\circ}\text{C}$  junction temperature.

### CCT=6000K (blue diagrams):

At a power consumption of around one Watt efficacy lies between 45 and almost 100 lumen/Watt.

Maximum lumen output of the best products is about 200 to 210lumens at 3.3 to 3.7 Watts. As result efficacy is lowered to 60% of the initial value, hence 55-60lm/W.  $T_j$  for these three products is between  $60$  and  $70^{\circ}\text{C}$

A product with a poor thermal design has at the initial 1.2W a junction temperature of  $60^{\circ}\text{C}$  and an efficacy of 50lumens/W and reaches at 2.5 Watts critical  $90^{\circ}\text{C}$  at an efficacy of 35lm/W.

### CCT=4000K (yellow diagrams):

The products split in two different groups. First, products with higher efficacy rated up to 2.5Watts; second, LEDs up to 5 Watts, but less efficient. Within this group we can also find one product in a version with a CRI of 70 and a version with a CRI of 85. This second version is at least 20% less efficient!

Highest luminous flux of almost 150 lumens is reached with an efficacy of 30lm/W at a power consumption of 4.9 Watts. As a consequence junction temperature reaches critical  $92^{\circ}\text{C}$ .

The least efficient product with just 24lm/W can produce 90lumens at 3.7 Watts and reaches a junction temperature of almost  $80^{\circ}\text{C}$ .

The most efficient LED just can stand a power of 2.4 Watts, but reaches 130 lumens with 55lm/W efficacy and therefore can hold junction temperature below  $60^{\circ}\text{C}$ .

### CCT=3000K (orange diagrams):

In the group with the lowest initial efficacy higher rated power consumption clearly produces also maximum luminous flux.

For maximum luminous flux of 150 lumens power consumption is almost 5W; as result  $T_j$  is  $92^{\circ}\text{C}$ . This product has a CRI of 70. The version with a CRI of 85 has 25% lower efficacy and luminous flux. The manufacturer claims the same data for the 3000K versions as they do for the 4000K versions.

The product with the best efficacy (58lm/W) at one Watt has a decrease of efficacy of almost 30%. It is just rated up to 2.4 Watts, but junction temperature can be kept well below  $60^{\circ}\text{C}$  at a luminous flux of 100lm.

The least efficient product generates a lumen output of 95 lumens with an efficacy of 18lm/Watts at 5.5W, but a low junction temperature of  $62^{\circ}\text{C}$ .

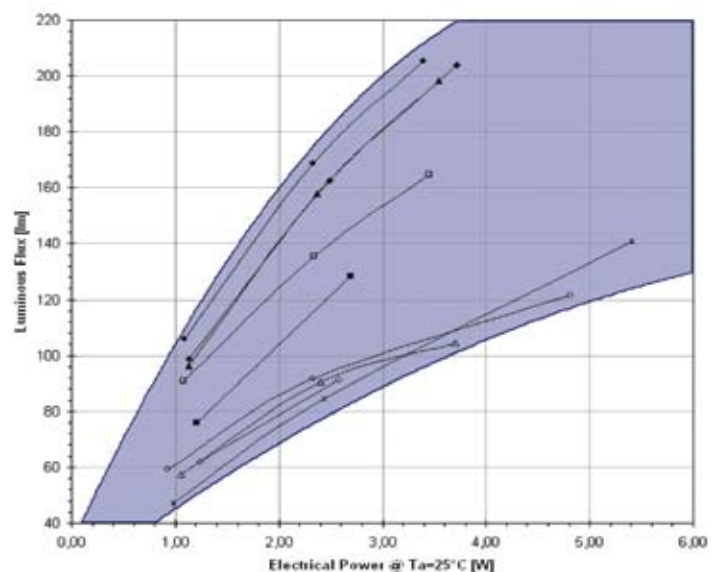
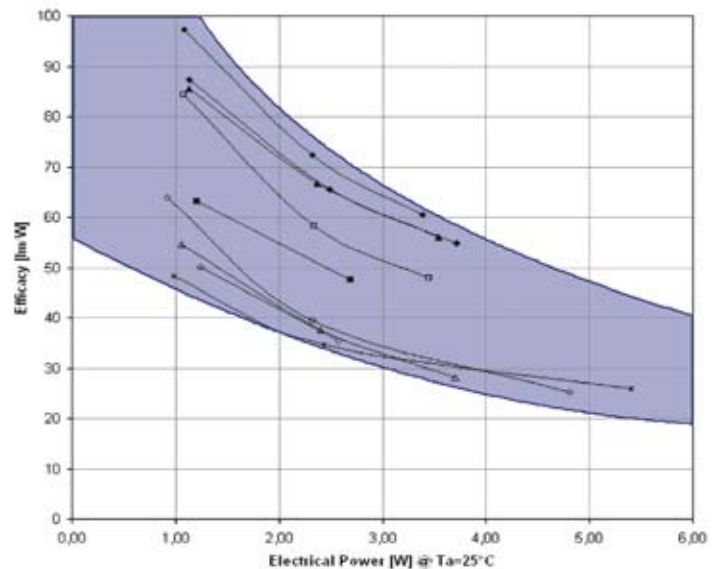
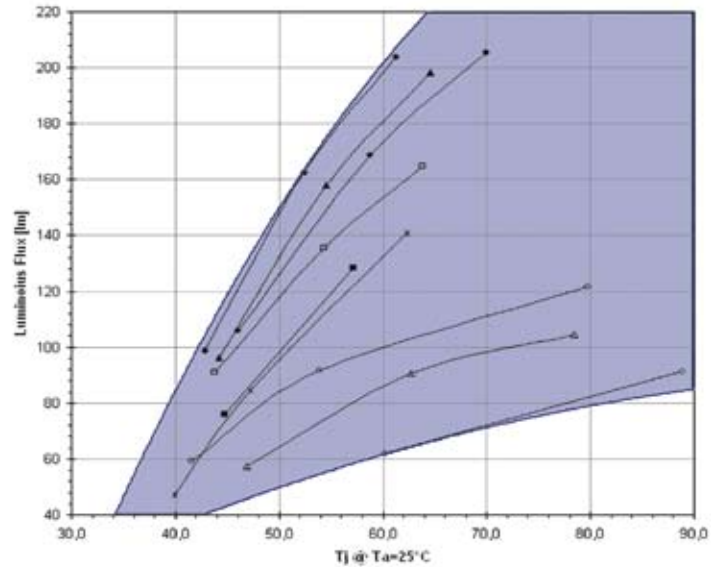

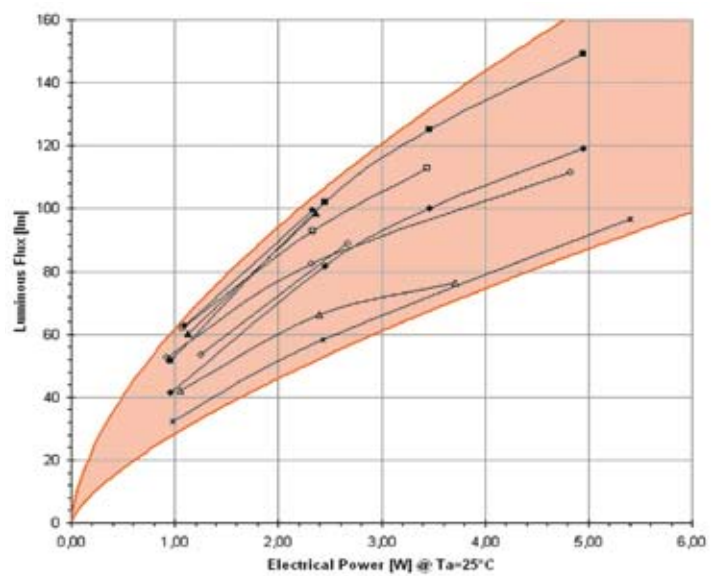
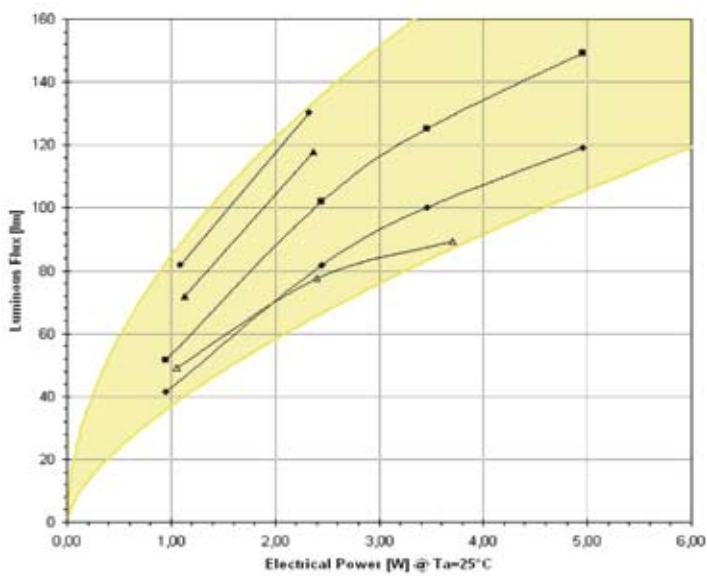
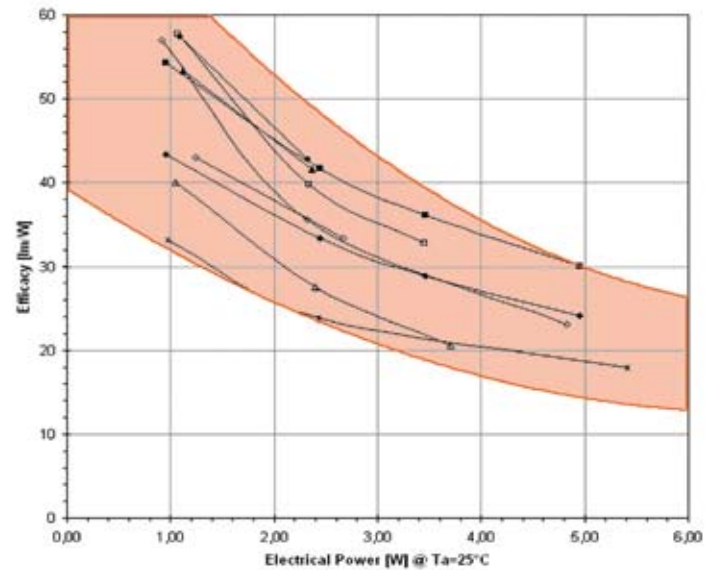
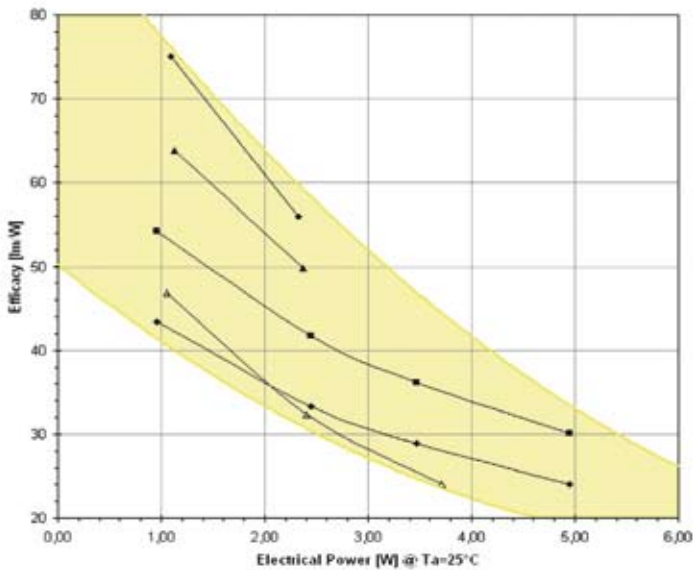
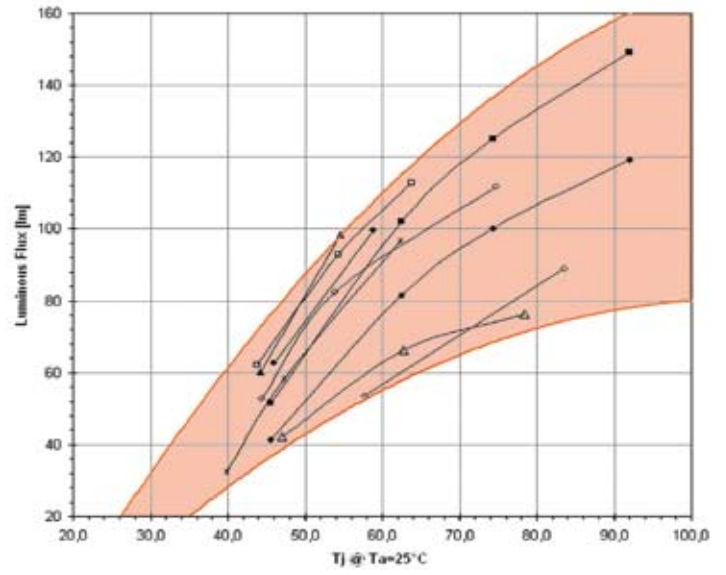
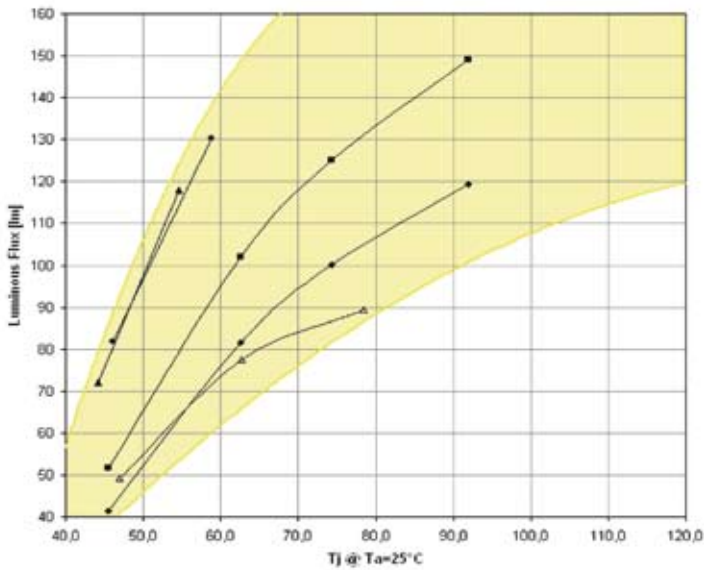

## Calculated result for $T_{Amb} = 50^{\circ}C$

It had to be expected that under these conditions efficacy and luminous flux would be relatively low, but junction temperature of some products rises above critical  $100^{\circ}C$  at maximum power and even  $60$  to  $70^{\circ}C$  at initial power. Even if no product reaches allowed limits, lifetime will be shortened dramatically at these temperatures.

At the maximum rated power most LEDs barely reach  $50$  to  $60\%$  efficacy of the initial datasheet values.. Products with lower maximum rated power are more efficient.

Maximum luminous flux is  $180$  lumens for CCT= $6000K$ ,  $120lm$  for  $4000K$  and just  $110lm$  for warm white, whereby power consumption of the warm white LED is at  $4.8W$ . In both other groups an efficient solution and not the maximum rated power is crucial.

### CCT= $6000K$ (blue diagrams):

Even under these conditions the most efficient products emit up to  $180lm$ , consuming between  $3$  and  $3.4$  Watts with an efficacy of  $52$  to  $58lm/W$ . The junction temperature for these products is between  $85$  and  $95^{\circ}C$ .

The least efficient LED with  $45lm/W$  at the initial condition is less efficient than the best products at maximum rated power.

Maximum calculated junction temperature within this category is  $115^{\circ}C$  at  $2.4$  Watts, a luminous flux of  $90lumens$  and an efficacy of  $36lm/W$ .

### CCT= $4000K$ (yellow diagrams):

A product just consuming around  $2.5$  Watts has the best lumen output. Efficacy of this LED is  $52lm/W$  emitting almost  $120lm$ . The junction temperature of  $85^{\circ}C$  is moderate in relation to most competitors  $T_j$ .

A second product with similar power capabilities also performs quite well with almost  $110lumens$  and a junction temperature below  $80^{\circ}C$ .

The other products clearly exceed junction temperatures of  $100^{\circ}C$  with a power consumption of up to  $4.8$  Watts and emitting between  $80$  and  $110$  lumens.

### CCT= $3000K$ (orange diagrams):

Results are comparable to  $T_{Amb}=25^{\circ}C$ . The LED with a rated power of  $4.8$  Watts emits  $115lm$ , but runs hot with  $115^{\circ}C$ .

With a junction temperature of just  $88^{\circ}C$ , a power consumption of  $3.4W$  a second product overcomes the  $100lumens$  mark.

A whole bunch of products reaches up to  $90lm$ , with a power consumption around  $2.5$  Watts and junction temperatures of  $80$  to  $90^{\circ}C$ . These are – with almost  $40lm/W$  at  $2.4W$  and  $700mA$  – the most efficient products within this group.

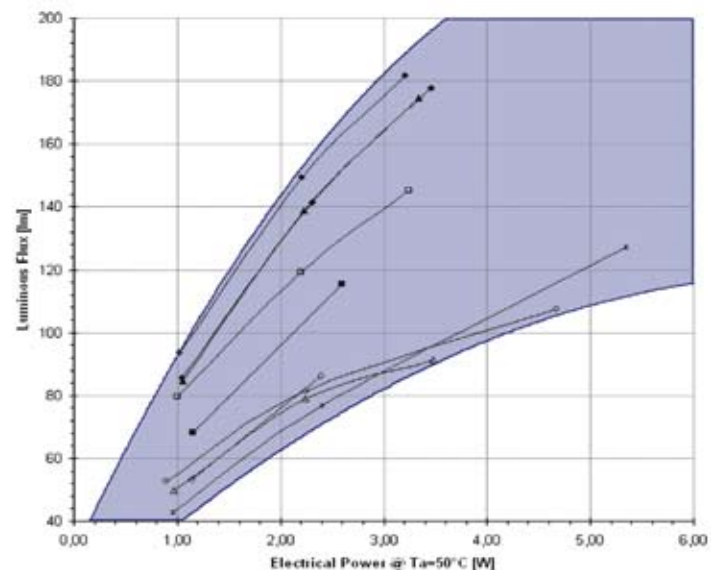
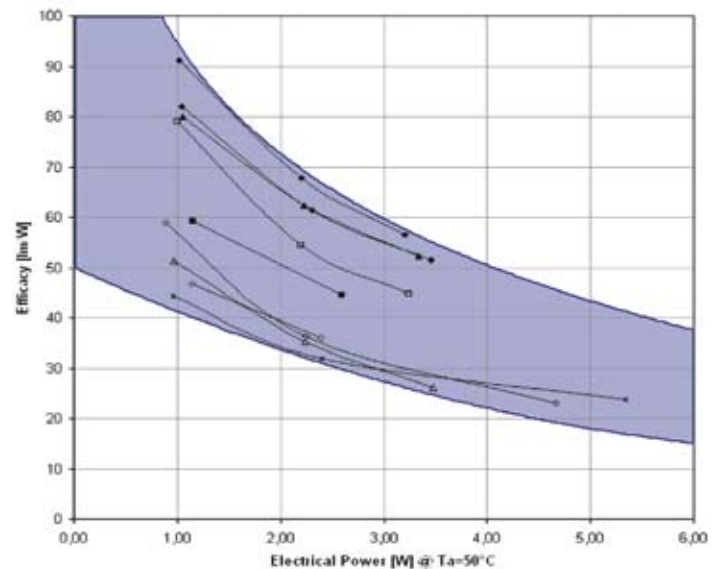
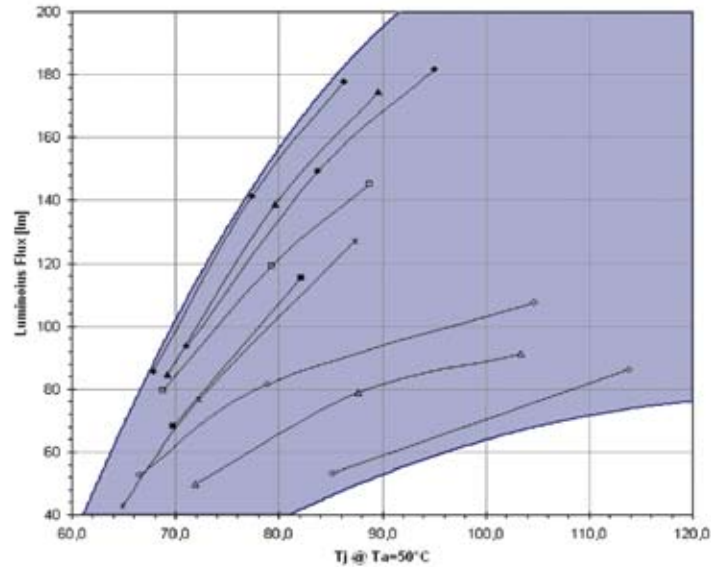

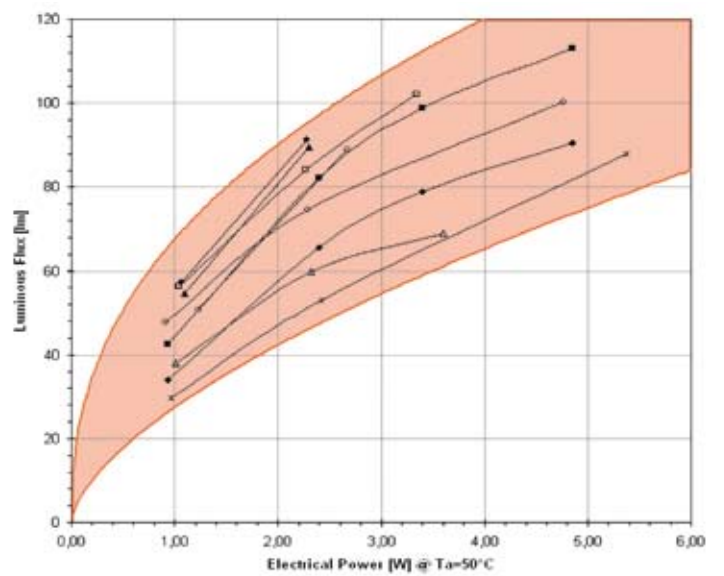
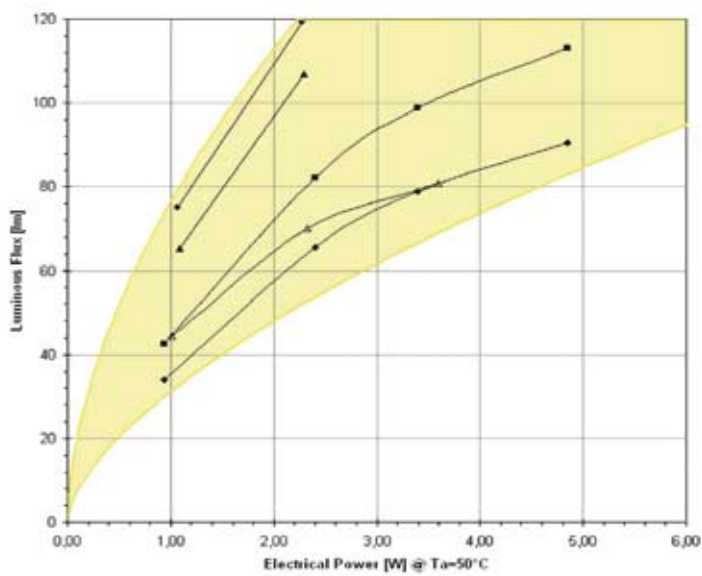
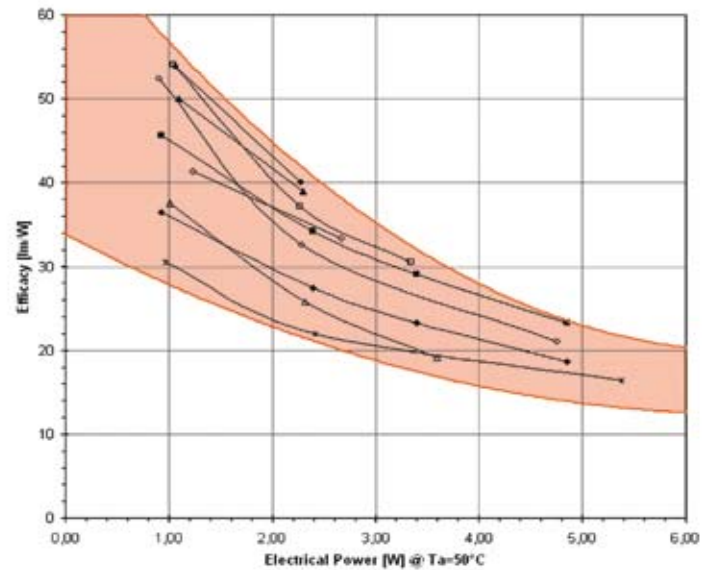
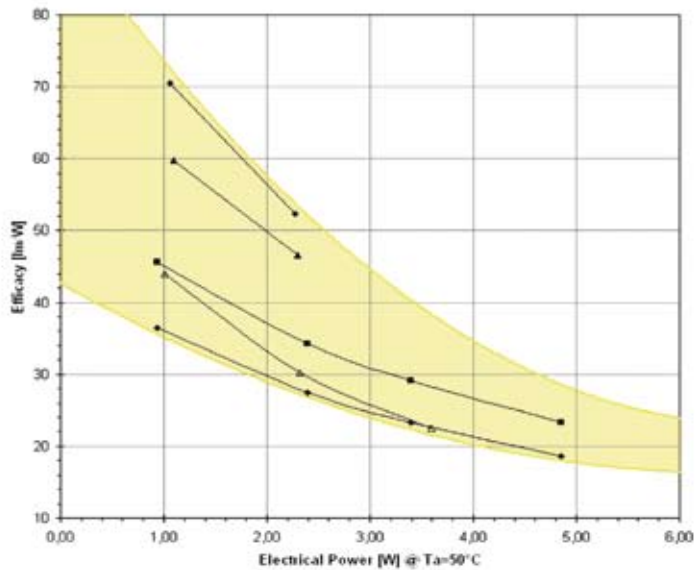
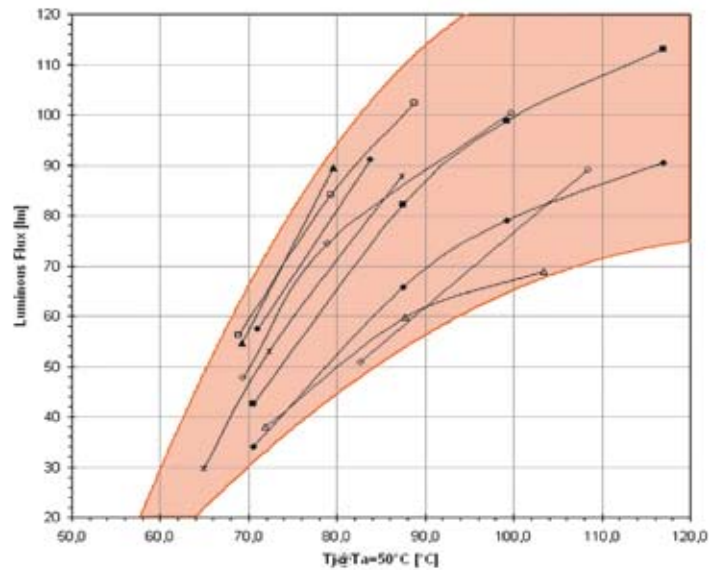
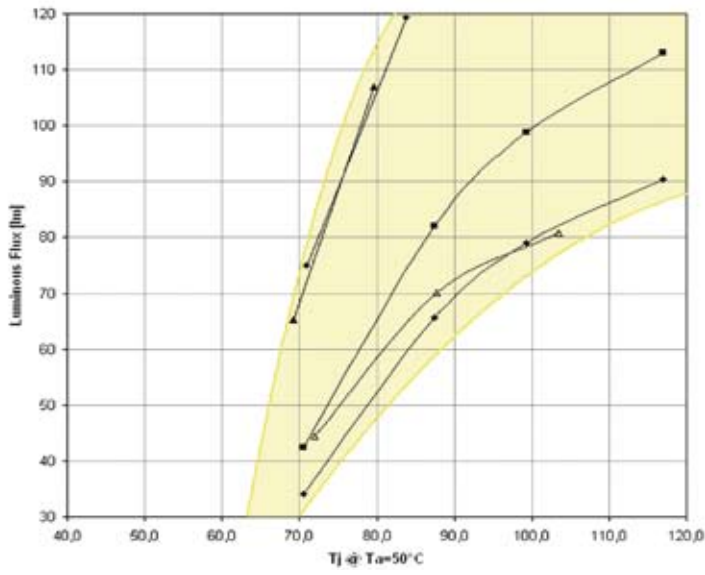

## Summary

Efficacy for the different products varies depending on the color temperature, power consumption and junction temperature within a range of 16lumens/Watt for the least efficient warm white LED at 5.4 Watt and 100lumens/Watt for the most efficient cold white LED at 1.1 Watt.

At the commonly used 350mA, as equivalent to 1 Watt +/-10%, the nominal efficacy range for LEDs with CCT=3000-3500K is 35 to 60 lumen/W, for LEDs with CCT=4000-4500K 45 to 75 lumen/W and for cold white LEDs (CCT>6000K) 50 to about 100 lumen/W.

At nominal power and an ambient temperature of 25°C efficacy reduces between 5 and 10%; at an ambient temperature of 50°C between 10 and 15%. This reduction depends predominantly on the thermal resistance of the product and heat sink design.

At the maximum rated power efficacy reduction is 30% up to 50% in relation to the nominal values. One fifth to one third of this reduction is a result of increased junction temperature (see: Temperature to normalized intensity curves in datasheets). The main portion, over two third of this reduction has to be explained by current dependent effects (see: Current to normalized intensity curve in datasheets).

At maximum allowed current power consumption can drop by 10% (from e.g. 5.3 to 4.8 Watts) depending on the junction temperature, caused by a voltage reduction through the temperature coefficient of forward voltage. It varies from -2 to -8mV/°C.

By the way it is remarkable that CRI has also a strong influence on efficacy too. The basically same product with an improved CRI of 85+ instead of 70 has a 20% lower efficacy; respectively the version with higher CRI is just available in a lower luminous flux-binning. In addition it's worth to notice that these products are claimed to have identical data for CCT=3000K and CCT=4000K.

## Conclusions

Recent products have very different performance regarding efficacy and luminous flux. For all products nominal data of datasheets are far better than what we finally can expect in real live applications.

Current, temperature and temperature coefficient of forward voltage are main influence factors. All three parameters have to be taken into account for design decisions very carefully.

Single chip and multi chip products behave differently. For single chip LEDs we can expect a higher influence of efficacy degradation by the current, because they have to handle a high current density. Multi chip solutions usually have lower current densities but are designed for higher power consumption; therefore thermal influence can be more distinct and also temperature coefficient of forward voltage can gain influence.

Well chosen driving currents, low thermal resistance of the LED package and an excellent, not to say sophisticated temperature management are key factors to achieve good efficacy, high luminous flux and durable products under real live conditions.

## Consequences for applications

For different applications and goals different design strategies might be beneficial:

To achieve good efficacy multiple LEDs should be driven well below maximum allowed current, because efficacy dramatically decreases at higher current and increased junction temperatures.

For a small and cost optimized design without the needs for highest luminous output and maximum efficacy, e.g. effect lighting, a single or low number of LEDs driven at maximum current can satisfy today's requirements. ■





LED by EVERLIGHT

# Full Colors Ultra Bright HighPower LEDs

With the leading innovation and specialty, EVERLIGHT develops the ultra bright, high-power LED in full colors, which within one single part that satisfies the demands of architecture and room lighting designs.

As the pioneer of the world-class LED optoelectronic industry, our everlasting enterprise mission is to develop the products integrated with environmental concern, to create better life for all mankind and charming delights of the world.



EHP-B02



EHP-5393



EHP-C04



The Leader of LED Optoelectronic Industry

#### EVERLIGHT ELECTRONICS CO., LTD.

TAIPEI HEADQUARTERS

TEL : +886-2-22672000 E-MAIL : [spc@everlight.com](mailto:spc@everlight.com)

AMERICA OFFICE

TEL : +1-972-4904008 E-MAIL : [salesmkt@everlight.com](mailto:salesmkt@everlight.com)

EUROPE OFFICE

TEL : +49-721-024473 E-MAIL : [info@everlight-eu.de](mailto:info@everlight-eu.de)

**EVERLIGHT**

LIGHTING FOREVER

# Light Extraction Boosts Efficiency of Vertical Light Emitting Diodes on Metal Alloy Substrate

> SemiLEDs Corp.

GaN-based sapphire-free Vertical Light Emitting Diodes on metal alloy substrate have recently shown a spectacular performance using a new surface engineering technique. Instead of a planar surface used in previous version, new VLEDMS employs a surface corrugated so the effective escape surface for photons and their angular randomization is enhanced. High power white LED having efficiency >100 lumen/watt is achieved through a combination of surface engineering and optimization of the N-layer thickness underneath the corrugated surface.

## Introduction

The GaN-based wide band gap semiconductor is widely used in various applications such as the handset keypad, LCD backlighting, camera flash and full-color outdoor display. However, the use of Light Emitting Diodes (LED) for solid state lighting applications were limited, due to technology problems associated with GaN based conventional LEDs on sapphire. Vertical sapphire-free GaN based LEDs on metal substrate (VLEDMS) have shown much better performance and promise to deliver an efficiency much higher than any conventional light source [1]. In this paper we show that in addition to many advantages of VLEDMS over conventional LEDs, in terms of better current spreading, faster heat dissipation and higher electrostatic discharge, VLEDMS also enables new top surface engineering for efficient light extraction to further improve efficiency. The key to increasing the escape probability is to give the photons multiple opportunities to find the escape cone. This assures efficiency over 100 lumen/watt white LEDs using VLEDMS new structure [2].

## Drawbacks of conventional LEDs on sapphire

Figure 1(a) shows structural diagrams of the conventional GaN LED on sapphire substrate, first and second generation sapphire-free VLEDMS. For the conventional GaN LED on sapphire, the p-GaN layer thickness is usually kept below 2000Å, as p-GaN absorbs the photons with wavelength in the interested spectrum. To increase the light extraction efficiency, either truncated hexagonal pyramids or pits were formed on the p-GaN surface using various techniques. The drawbacks of the conventional structure for an effective light extraction lay in the

thickness of p-GaN layer which must be thin enough to avoid re-absorption of photons. In other words, any engineering of p-GaN surface may affect the active layer underneath leading to compromised device characteristics. The second drawback of conventional LEDs on sapphire is that it lacks a mirror on the backside to reflect photons back to the rough surface for a better light extraction. To overcome these shortcomings, VLEDMS was designed to boost the external quantum efficiency while relieving the demand for a thin p-GaN layer. All the surface engineering occurs on the thick N-layer (>4µm).

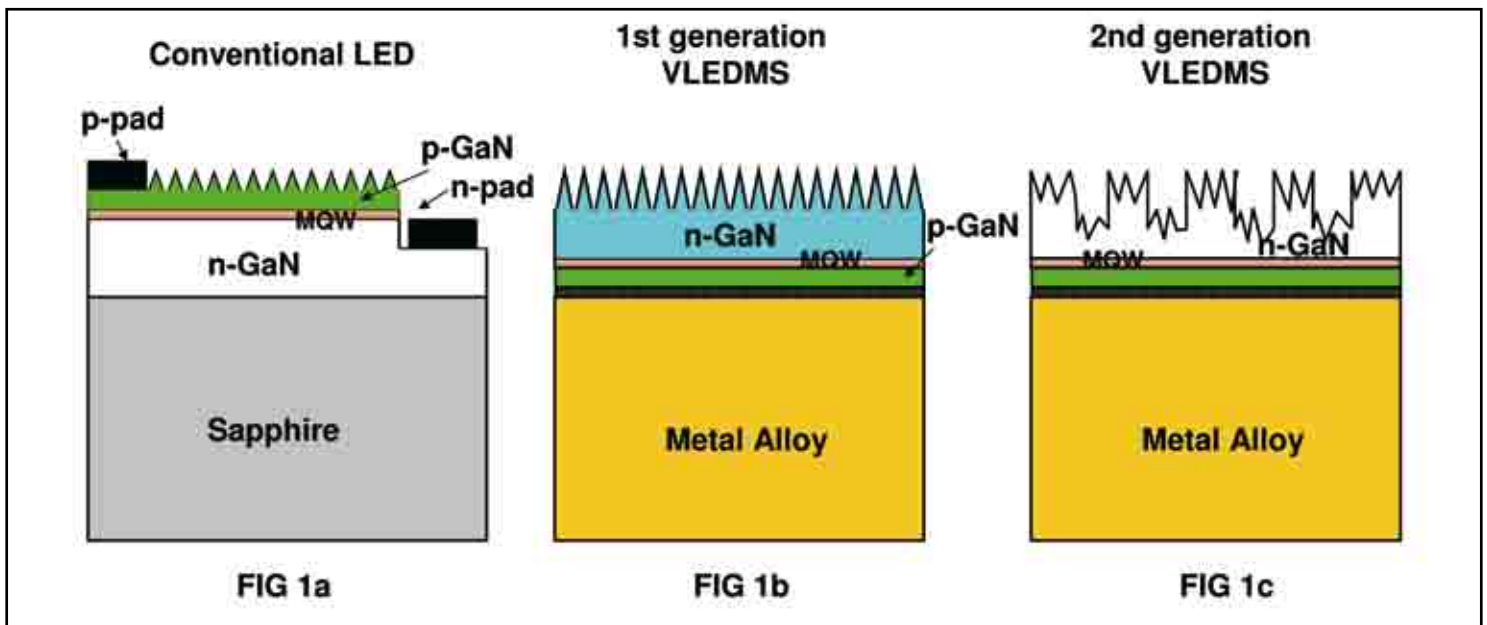

Fig. 1 (a) shows the structure diagrams of the conventional GaN LEDs on sapphire substrate.

Fig 1 (b) shows the first version of VLEDMS structure with the chemical etched top surface roughening.

Fig 1 (c) shows the second version of VLEDMS to enhance further the angular randomization by scattering of the photons at a corrugated, pyramid shaped surface.

In the first version of VLEDMS, the GaN LED structure is placed on a high reflectivity surface, as shown in the Fig.1(b) with the top surface roughened by etching to allowing more photon to escape the surface. To further enhance the number of photons escaped from the surface, a new technique to form corrugated pyramid shaped (CPS) surface as shown in Fig. 1(c) is developed. The new CPS surface increases the surface areas having angular randomization allowing more scattering of photons.

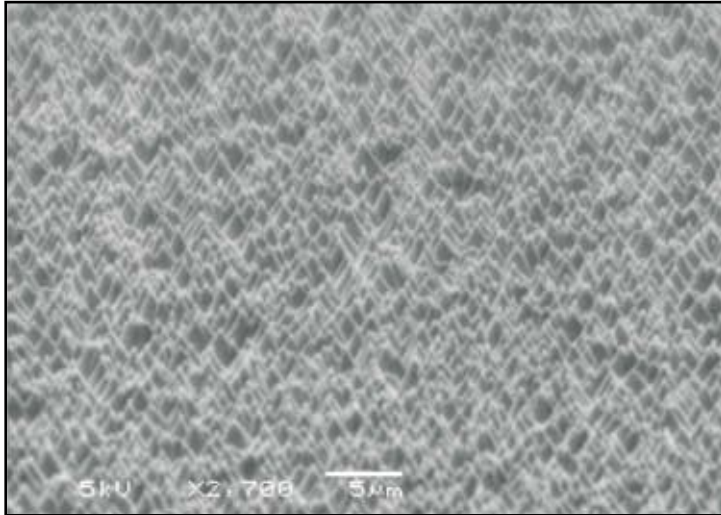

Fig 2a

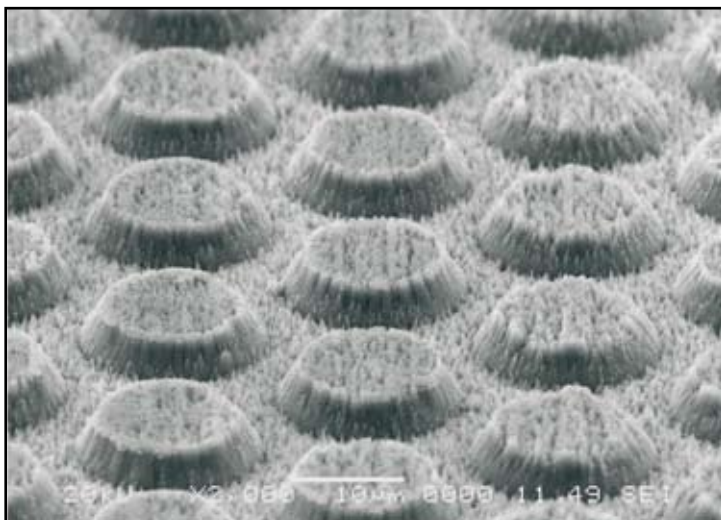

Fig 2b

The scanning electron microscope surface of VLEDMS of version 1 (shown in Fig 2(a)) and version 2 (shown in Fig 2(b)), respectively.

Figure 2 shows the scanning electron microscope surface of VLEDMS of version 1 and 2, respectively. At 350mA, an improvement of 20% is observed for the VLEDMS with corrugated pyramid shaped (CPS) surface as shown in Fig. 3(a).

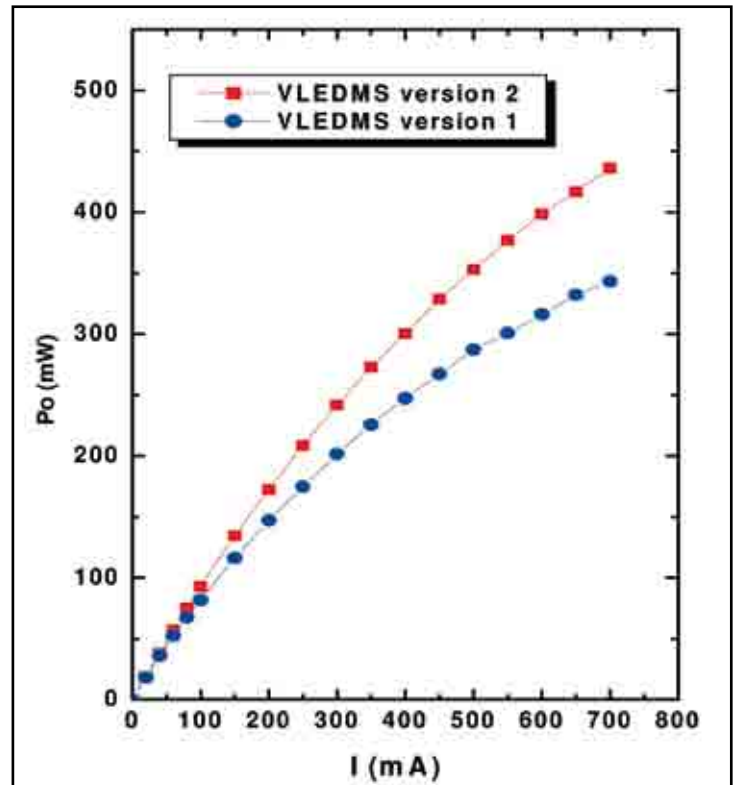

Fig 3a

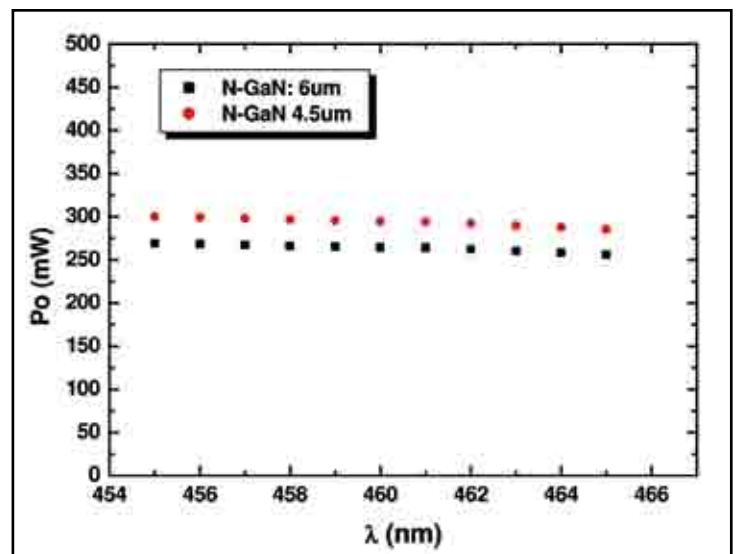

Fig 3b

VLEDMS with corrugated surface has power improvement of 20% as shown in Fig. 3(a). The brightness distribution of VLEDMS with different N-GaN thicknesses are shown in Fig 3(b).

Another aspect of the second generation VLEDMS is that the N-GaN layer averaged thickness can be tailored much thinner than in the case of a planar VLEDMS. Any re-absorption of photons in the N-layer by free electrons or by the mid-gap states will lead to a loss of efficiency. Besides providing higher extraction (more scattering sites), the VLEDMS

with CPS technology also lowers the effective N-GaN thickness minimizing the re-absorption effects without scarfying the quality of the active layers. Fig. 3 (b) shows the brightness distribution of VLEDMS with different N-GaN thicknesses. A reduction of N-GaN layer thickness from 6 microns to 4.5 microns improves 12% of brightness.

## Roadmap of VLEDMS efficiency

There is no doubt that the efficiency is the first factor which determines the success of LEDs in the process of replacement of conventional light sources. In this aspect, VLEDMS has many advantages over the conventional LED on sapphire. The advantages for the GaN VLEDMS are the following: First, there is only one n- electrode pad directly made on the top of the n-GaN. The active layer remained intact and can emit more light in comparison with conventional GaN LEDs on sapphire in the same chip size. Second, the direction of current path of the VLEDMS is vertically from the bottom anode to the top cathode. Therefore, the vertically current path [3], without current crowding effect, has much lower serial dynamic resistance than that of the lateral current path. In addition, the n-GaN has much higher conductivity than that of p-GaN. The n-GaN can spread the current well without using any semi-

transparent conductive layer. Thus, no light was absorbed by the semi-transparent layer and higher light output efficiency could be obtained [1]. The better current spreading of n-GaN allows scaling up the chip size without a loss in efficiency. Third, due to the highest thermal conductivity of the metal alloy substrate, the VLEDMS have much higher heat dissipation capacity [4-5]. Consequentially, higher current operation condition could be achieved, especially for the solid state lighting application. Table 1 shows data of 40 mil chip packaged with phosphor to produce white light. At 350mA, >100 lumens output was observed. As mentioned above, the package can sustain the current much higher than 1A while still preserving high efficiency: >60lumen/watt at 3.5 W.

MvpLED Performance (Integrating Sphere Model: ISP500-100)								
IF(A)	Im	W	x	y	CRI	CCT	Wd	Wp
0.350	100.732	0.283	0.34863	0.378872	73	4966	566.1	456.1
0.350	101.56	0.286	0.34823	0.377422	73	4976	566.2	455.5
0.700	171.788	0.509	0.3459	0.372296	73	5034	565.8	454.8
1.000	228.887	0.683	0.34498	0.369926	73	5062	565.7	453.9

Table 1: The data of 40 mil chip packaged with phosphor to produce white light.

The roadmap of VLEDMS efficiency is shown on Fig. 4. Using new and optimized EPI and device structures together with advanced CPS technology, the next generation single chip VLEDMS operated at 350mA having light output greater than 150lumens will be achieved by mid 2008.

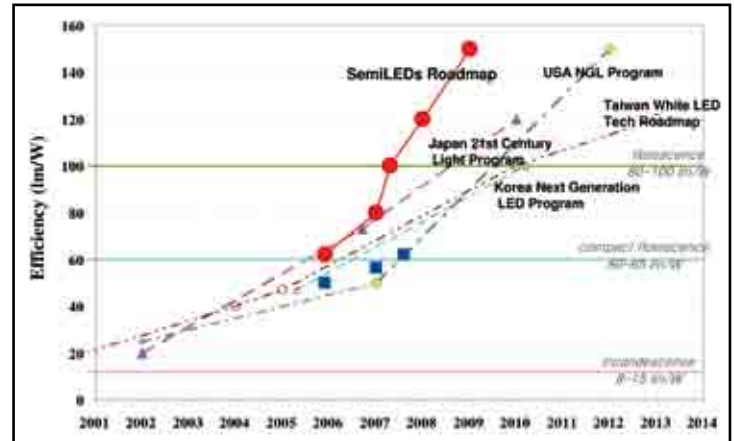

Fig 4 shows the roadmap of VLEDMS efficiency.

## Conclusion

In conclusion, the VLEDMS new version for better light extraction is described and characterized in this article. An efficiency of 100 lumen/watt or better was achieved by optimization of rough, corrugated surface to enhance randomization of photon scattering. A roadmap of improved efficiency of VLEDMS will certainly contribute to advancement of solid state lighting as 150 lm/watt is scheduled to be achieved by middle 2008. ■

## References

- [1] T. Fujii, Y. Gao, R. Sharma, E. L. Hu, S. P. DenBaars and S. Nakamura, *Appl. Phys. Lett.* 84 855 (2004).
- [2] I. Schnitzer, E. Yablonovitch, C. Canneau, T. J. Gmitter and A. Scherer, *App. Phys. Letter* 63(16), p. 2174 (1993)
- [3] Z. S. Luo, Y. Cho, V. Loryuenyong, T. Sands, N. W. Cheung, and M. C. Yoo, *IEEE Photo. Tech. Lett.* Vol. 14, 1440, (2002).
- [4] T. Doan, C. Chu, C. Cheng, W. Liu, J. Chu, J. Yeh, H. Cheng, F. Fan and C. Tran, *Proceedings of SPIE* 6134, 61340G-1 (2006).
- [5] Chen-Fu Chu, Chao-Chen Cheng, Wen-Huan Liu, Jiunn-Yi Chu, Hao-Chun Cheng, Feng-Hsu Fan, Jui-Kang Yen, Chuong Anh Tran, Trung Doan, *Phys. Stat. Sol. (c)* Vol.4, Issue 1, 17-20 (2007).

# LEDs. The next dimension in lighting technology.

[www.tridonicatco.com](http://www.tridonicatco.com)



Ster Century Thessaloniki, Grecia

High quality of light, high efficiency, more colour, greater dynamics – and all with exceptional economy. With powerLED from TridonicAtco you have greater control over light. For architecture and object lighting, for illuminated signage and emergency lighting, for traffic systems and for industrial applications. As a pioneer of chip-on-board technology and dynamic lighting, TridonicAtco has developed powerLED for maximum life and perfect output. See for yourself – at [www.tridonicatco.com](http://www.tridonicatco.com)

a world of bright ideas®

**TRIDONIC.ATCO**

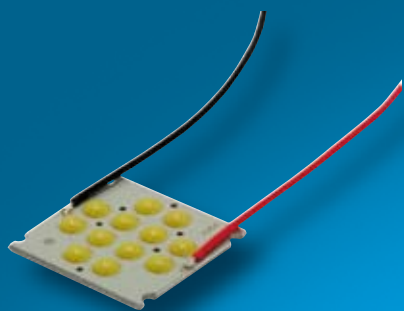

powerLED EOS P216



powerLED EOS P211



LED Converter



LED Controls



Accessories

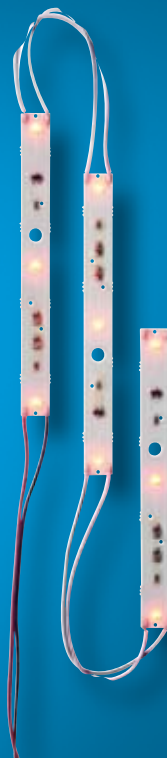

LED Chain P515

## LED Drivers

# How linear LED driver IC's can make it irresistible to replace resistor biasing

> Joachim Glaeser, Hakan Yilmazer, Infineon Technologies AG

As it seems to be the cheapest and easiest way to use a simple resistor to limit the current in an LED string why should one bother using linear driver ICs?

In fact, the benefits offered by linear drivers outweigh by far their higher purchasing cost in comparison to resistors. The most important advantages are:

- Avoidance of complicated and costly logistics of different resistor types for compensation of varying forward voltages. Adjusting the brightness can be done by PWM dimming.
- Decrease of the system cost because a non-stabilized system supply can be used.
- Reduction of space required on board
- More LED's within a string and herewith system efficiency improvement.
- Ideal biasing and protection of the LED's in order to maximize lifetime.

There are numerous applications like signage, rope lights, advertising panels, architectural lighting, automotive interior and exterior lighting, aircraft lighting etc. where linear drivers very often meet the sweet spot of the respective application.

Besides the mentioned advantages, linear drivers face their limits at battery based mobile applications where boost of the supply voltage is required.

The following explains the advantages and gives hints for implementing linear LED drivers.

### Benefit from constant current

Due to its diode characteristics, a LED requires a source of constant current rather than constant voltage. Limiting the LED current to a constant value with a series resistor would need a large voltage drop across the resistor, reducing system efficiency. On the other hand, a small voltage drop across the series resistor would lead to large deviations from the desired LED current when system voltage or LED forward voltage varies.

Maintaining a constant LED current protects the LEDs from overheat due to over-current caused by system voltage or LED forward voltage variation. Adaptation of the series resistor to different LED forward

voltage classes becomes obsolete. Hence, LED drivers help to improve the overall preciseness of the system's luminosity. Degradation in light emission is minimized.

Figure 1 shows an automotive application using 3 LEDs with a nominal forward current of 350mA. Very low drop out voltage increases system efficiency. Selecting a series resistor would be quite difficult: at low battery voltage, the forward current would be low and the LED brightness not sufficient. In case of transients (load dump, double battery), the LEDs may be damaged. A constant current source would prevent damage and offer higher brightness at low battery.

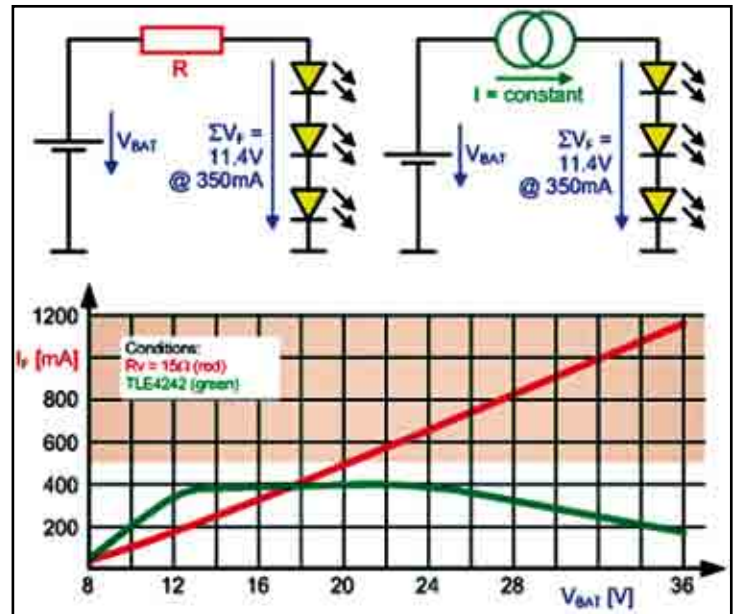

Figure 1: LED driving with series resistor versus constant current LED driver TLE4242

The maximum number of LEDs in a single string strongly depends on the voltage drop across the resistor or LED driver. When using a resistor, a large voltage drop is desired to achieve the most constant current possible. However, this means generating heat instead of light. A linear LED driver combines both, low drop across the IC and constant current. More LEDs per string are possible, which leads to a higher efficiency of the entire system.

The drop out voltage for the TLE 42xx series is typ. 0.5V, max. 0.7V; for the BCR 4xx series typ. 1.2V, max. 1.5V.

### No passive filtering components

Unlike switched mode converters that boost to a high voltage in order to supply a long LED chain, there is advantage of parallel strings: As linear drivers produce no emission, almost no external components are needed leading to negligible costs for passive filtering components.

### Use as high side switch

Infineon linear LED drivers can be switched off by a logic signal. The TLE 4241 and TLE 4242 consume less than 1µA quiescent current in off-mode which make them suitable to use as a high side switch.

## Dimming via PWM

There are two possibilities to dim a LED: Adjusting its forward current level or PWM of a predefined forward current. However, modifying the forward current is not preferred for two reasons: Firstly, the LED is not operating at its optimum efficiency point over the brightness range. Secondly, a forward current different from the nominal LED current may lead to a color shift of the light output. PWM dimming solves both of

these problems by modulating the LED output with a low-frequency PWM signal. The LED is turned on at a single current drive level. Its brightness is adjusted by changing the average amount of time that the LED is active. Dependent on duty cycle, the frequency should not be lower than 200Hz; 500Hz to 1kHz is normally sufficient. PWM control is integrated into a single chip solution as the TLE 4241, TLE 4242 or BCR 450. The Infineon BCR 40x series allows PWM dimming by using an external digital transistor.

## LED diagnosis

In order to identify a failing LED, the TLE 42xx series indicates an open load condition at the status output. It can be directly connected to a microprocessor using a pull-up resistor to VCC.

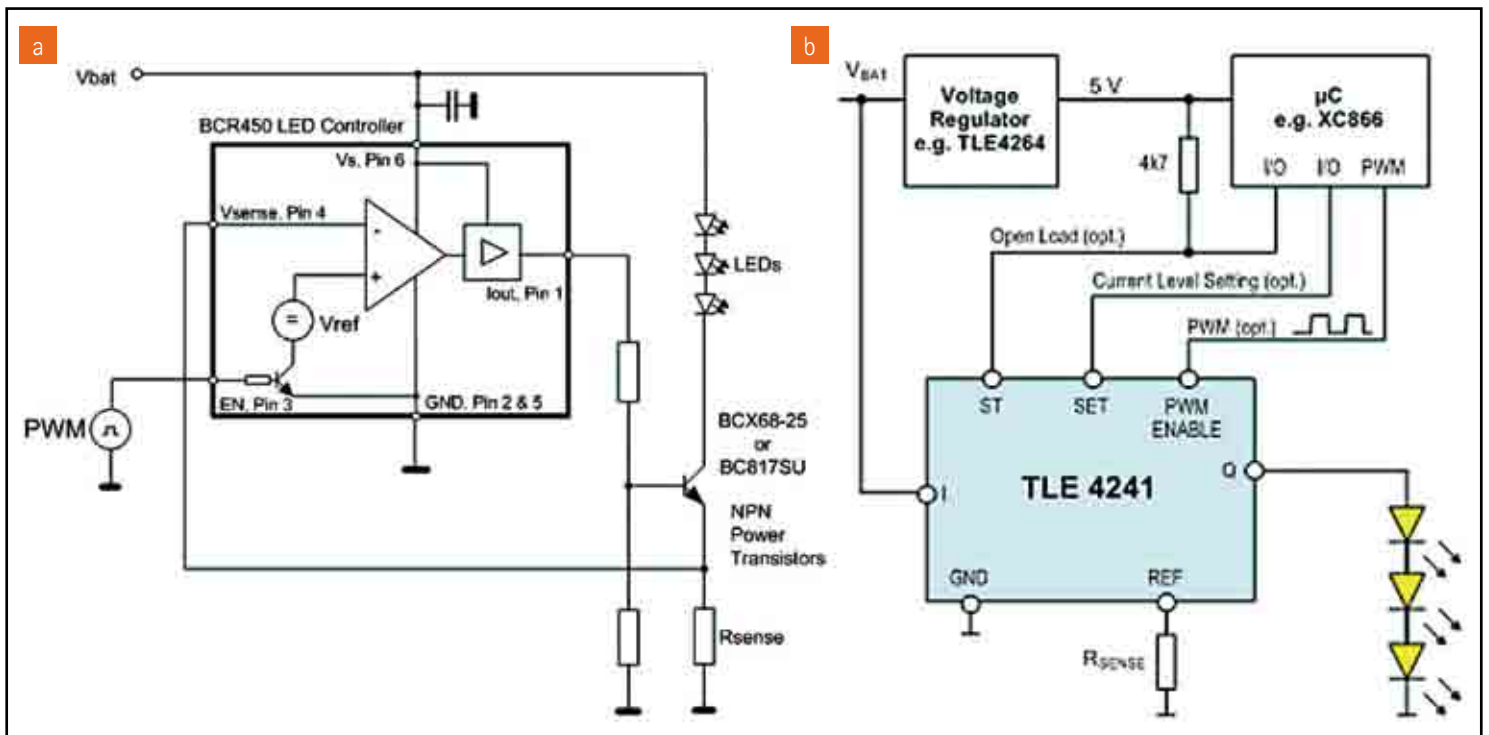

Figure 2: shows different application possibilities for using linear LED drivers (Fig 2a left, Fig 2b right).

### Notes:

a: Low cost BCR 450 linear LED driver used in combination with external power stage.

b: The TLE 4241 LED driver provides PWM control and open load detection

## Protection and safety

LEDs generally have a positive temperature coefficient, i.e. the LED forward voltage decreases as the LED gets warmer, causing the LED to draw more current as temperature goes up. This potentially leads to thermal runaway and destruction of the LED. Therefore, constant current control of the diode current is required.

Infineon's TLE 4xxx and BCR 4xx linear constant current LED drivers are suited for use in harsh environments like traffic lighting, architectural lighting, railway, transportation or automotive applications. The products allow transients up to 45V (dependent on type) and operate at junction temperatures up to 150°C which allows substantial headroom for self-heating. In case of system faults, over current and over temperature protection safeguard the IC and the application. The TLE 4xxx series withstands a reversely connected supply voltage.

## Possibilities for heat dissipation and distribution

In order to minimize heat generation and to achieve constant brightness at varying system voltage, the maximum sum of the LED forward voltage shall be close to, but equal or below the supply voltage minus the LED driver's dropout. The maximum losses at the LED driver occur at minimum LED forward voltage and maximum input voltage.

Several possibilities for heat dissipation and avoiding temperature gradients on the PCB are appropriate:

- Use of several tiny and cost effective packages in parallel, but separated from each other on PCB.
- Separating of driver circuit and power transistor (for example see Figure 2a). The principle also allows adapting the power transistor to the diode current actually required.
- Use of high performance packages with tab as the tiny SCT595 or the larger TO263 for good thermal contact to the PCB and lowest thermal resistance.

---

## Summary

Linear constant current LED drivers are the most cost-effective method of optimal LED driving. Their flexibility and technical advantages increase efficiency, optimize system costs and help LED applications to become widespread. ■



# LED Driving Solutions for Efficient Lighting Applications



## Efficient LED Control from Microchip

- High efficiency solutions
- Intelligent control for additional functions
- Off-the-shelf reference designs
- Range of options to drive LED current
- Solutions for lighting control standards – 0-10V, DMX512, DALI

Energy-saving LED lighting requires highly efficient solutions to drive the LED current. Using a switch-mode power supply (SMPS) minimises energy wasted in the control circuitry.

Microchip offers a broad range of SMPS solutions for LED driving, with a selection of reference designs that lets you decide the trade-offs between circuit

complexity; component count; input and output voltages; and other factors.

Need intelligent control? Microchip provides solutions for simple analog driver ICs that can be used independently or with a microcontroller for added intelligence, as well as applications examples that integrate the LED drive function into the microcontroller.

**For more information on LED Driving Solutions, go to the  
Microchip Lighting Applications Design Center at**

**[www.microchip.com/lighting](http://www.microchip.com/lighting) or contact us at [lighting@microchip.com](mailto:lighting@microchip.com)**

**microchip**  
**DIRECT**  
[www.microchipdirect.com](http://www.microchipdirect.com)

New  
**Pb-free!**  
RoHS Compliant

 **MICROCHIP**  
[www.microchip.com](http://www.microchip.com)

The Microchip name and logo are registered trademarks of Microchip Technology Incorporated in the USA and other countries. All other trademarks and registered trademarks are the property of their respective owners. © 2007 Microchip Technology Inc. All rights reserved. ME175Eng/06.07

## Next Generation LED Area Lighting

>Bernie Weir and Frank Cathell, ON Semiconductor

There is significant global attention focused on the need for energy efficient lighting. According to an International Energy Agency report, electrical lighting globally consumes approximately 19% of electricity produced. Recent news reports and government proclamations have focused attention on the inefficiency of the incandescent lamp and heightened awareness at the consumer level to more energy efficient solutions such as compact fluorescent lamps (CFL). In addition, as high brightness white LEDs continue to advance, they represent another promising technology for energy efficient general lighting. In addition, the US ENERGY STAR™ program is drafting standards for Solid State Lighting at the residential and commercial level. What these news events fail to highlight is that roughly 70% of the energy consumption for lighting is outside the home and involves uses such as retail, industrial manufacturing, and public services such as schools, hospitals and area illumination. This last area covers a variety of applications such as roadway illumination, pedestrian thoroughfares, parking structures as well as the lighting of public spaces such as parks. In addition in the private sector, large area lighting is used in industrial plants and on-site parking for retail and commercial structures. Without a doubt, within this space, there are significant opportunities to develop more energy efficient lighting solutions.

Large area illumination entails more than simply providing lighting as it must address aspects of public safety, operating environment, style and aesthetic considerations, energy consumption, system reliability and maintenance costs, as well as the task of managing where the light is being projected to provide adequate light while avoiding light trespass, glare and light pollution. The pattern and illuminance requirements are critical for roadway lighting and are dictated by the street type, expected traffic flow, and agreed upon standards. As a result, there are many different designs of area lights to address practical considerations as well as energy use and architectural concerns. For example, in 2004 New York City sponsored an international City Lights design competition to see what new design ideas could be developed to give the city an innovative streetscape for the 21st century and replace the designs that had been in place over the last 50 years.

The most common light sources for area lighting are high intensity discharge (HID) types such as high pressure sodium, metal halide, as well as low pressure sodium and mercury vapor lamps. Advanced HID lamps such as metal halide have good efficacy of >80lm/W and reasonable lifetimes of 10-15K hours. This translates into 2-4 year lifetime when used 4000 hrs/year (typical Northern Europe usage pattern). Unfortunately due to the difficulty of access, the cost of replacing a lamp in street light is expensive in terms of maintenance time and labor cost. Replacement can be very problematic in tunnels and bridges where access is limited and can result in traffic congestion if a lane must be

blocked for repair. In addition, burned out street lights have public safety implications as well and some municipalities have strict time limits for replacement time. Other issues with certain lamp types is that they may typically take 5 minutes to start and if there is a power failure it may take up to 20 minutes to restart a hot lamp. Beyond energy consumption, there are other environmental considerations since most HID lamps contain mercury, they must be properly disposed of so the mercury does not enter the ecosystem. Even though current generation lamps are reasonably energy efficient, since the lighting stock has a typical lifecycle of 30+ years, not all area lighting employs high efficiency lighting technologies. A recent report prepared by the E-Street Initiative on Intelligent Energy funded in part through the European Union estimated that there are roughly 90 million public light sources through Europe and of them, approximately 1/3 are based on high pressure mercury vapor lamp technology which is not energy efficient. The focus of the E-Street initiative is to study the application of smart network controlled lighting systems to reduce energy consumption. For example a network lighting infrastructure could be controlled to reduce light output in the late evening when there is very limited traffic on the roadway thus saving energy. As can be seen, there are numerous factors why significant attention has been drawn to understand how new technologies can be brought to bear to address these challenges.

There are a number of reasons that high brightness "white" LEDs are of interest in this area. First and foremost is their long lifetime. Properly engineered LED systems can achieve more than 50,000 hours of operating life to 70% lumen maintenance. With lifetimes such as this, an outdoor area light can achieve an operating lifetime of more than 12 years which significantly reduces the ongoing maintenance and replacement costs. Secondly, LEDs continue to advance rapidly in terms of performance and cost. Commercially available high power white LEDs can achieve light output of 70-100 lumens per lamp with efficacy in the range of 70 lm/W. The Optical Industry Developers Association (OIDA) recently updated their white LED roadmap and they are now anticipating that by 2009 performance will more than double to 200 lm per lamp with efficacy of 150 lm/W. As a point of reference a 100W Metal Halide HID lamp may produce 8000-9000 lumens. It is not exactly fair to compare Lamp and LED output directly since lamps have light output in all directions and there can be significant fixture losses in getting the light to the pavement. This is not an issue for LEDs since they are direction in nature. Without taking into effect the luminaire losses, approximately 120 LEDs (70 lm/package) would be necessary to replace the lumen output of a 100W lamp. This number would be reduced in half if the 2009 OIDA goals are achieved. Moreover White LEDs can offer improved quality of light especially when compared to high pressure sodium lamps which have a yellowish orange light and a poor Color Rendering Index. LEDs also offer designers new flexibility to create innovative and distinctive lighting fixture designs. In addition, since LEDs are low voltage DC devices, it makes it easy to create new off-grid lighting concepts such as LED light bus stops which combine solar cells with rechargeable batteries. Systems like these are already deployed in places like the City of London.

LED array fixture designs vary widely as the light requirements are dictated by the specific lighting requirements of the location. The area to be illuminated is dependent on the height of the luminaire and the spacing between poles. For example a pedestrian/bike path may have relatively short poles and require 20 LEDs to light an area while a residential street light may require 100 LEDs or more. In addition, street lighting has very specific light pattern requirements since the goal is to light up the roadway without shining the light into the front of the houses that are on the street so there are specific patterns that must be met depending on the type of installation which requires more complex optical designs. There are also tradeoffs between the number of LEDs used and the drive current. In principle, fewer LEDs driven at higher current may seem like a viable choice, but the higher current and power may significantly complicate the thermal management. Moreover, LED efficacy drops with increased current and junction temperature. Of course one must keep in mind that to achieve the specified LED lifetimes, the junction temperature rating must be respected. Thermal considerations are an important factor for LED based luminaires since the heat dissipated is concentrated in the LED package and must be removed from the fixture.

A LED luminaire consists of one or more arrays of LEDs, along with control electronics to convert the AC mains power into current for the LEDs. Since area lights requirements need different lumen output, one approach to be considered is a modular design consisting of a string of LEDs and a driver circuit. Multiple strips would be used depending on the required light output. The advantage of this concept is that the same electrical design can be reused for different lighting requirements by adding further arrays. In addition since multiple arrays are used within a luminaire, if there was a single electrical open circuit LED, only a single strip of LEDs will cease operation so the luminaire will continue

to provide light albeit at a reduced level. The electronic controls need to comply with industrial and international standards. Within the EU, this type of product falls within IEC61000-3-2 which applies limits to power line harmonic distortion (power factor). Even in regions such as the United States where this standard is not in use, the utility companies typically require a minimum power factor for un-metered area lights, typically >0.90. There are passive approaches to this using heavy, mains frequency (50/60 Hz) inductors and capacitors; however, the active switch mode approach is commonly used in ballasts. In this latter case an additional boost type PFC converter is employed ahead of the main converter to provide power factor correction.

One additional consideration is whether galvanic isolation is required for safety. For area luminaires where access is limited, it is not uncommon to see a non-isolated design. The main advantage of a non-isolated design is that a bulky transformer can be replaced with a lower cost inductor. Next it is important to consider the real requirements in driving LEDs. While LEDs do require a constant current, this current does not have to be pure DC, but can be a pulsating DC as long as the average and peak values of the current are compliant with the LEDs' specified current ratings. And third, although the RMS current output should be regulated, the LEDs present a constant load to the power supply such that transient response characteristics of the supply are not an issue. As a consequence, a simple yet effective PFC and constant current converter can be implemented within one power stage using ON Semiconductor's NCP1216 control IC along with a power MOSFET, an inductor and a few additional passive components. Since the output typically does not require filtering of the 100/120 Hz line frequency component, large electrolytic capacitors are not required in the circuitry which not only reduces size, but improves overall power supply reliability. A schematic of the circuit is illustrated below (see Fig.1):

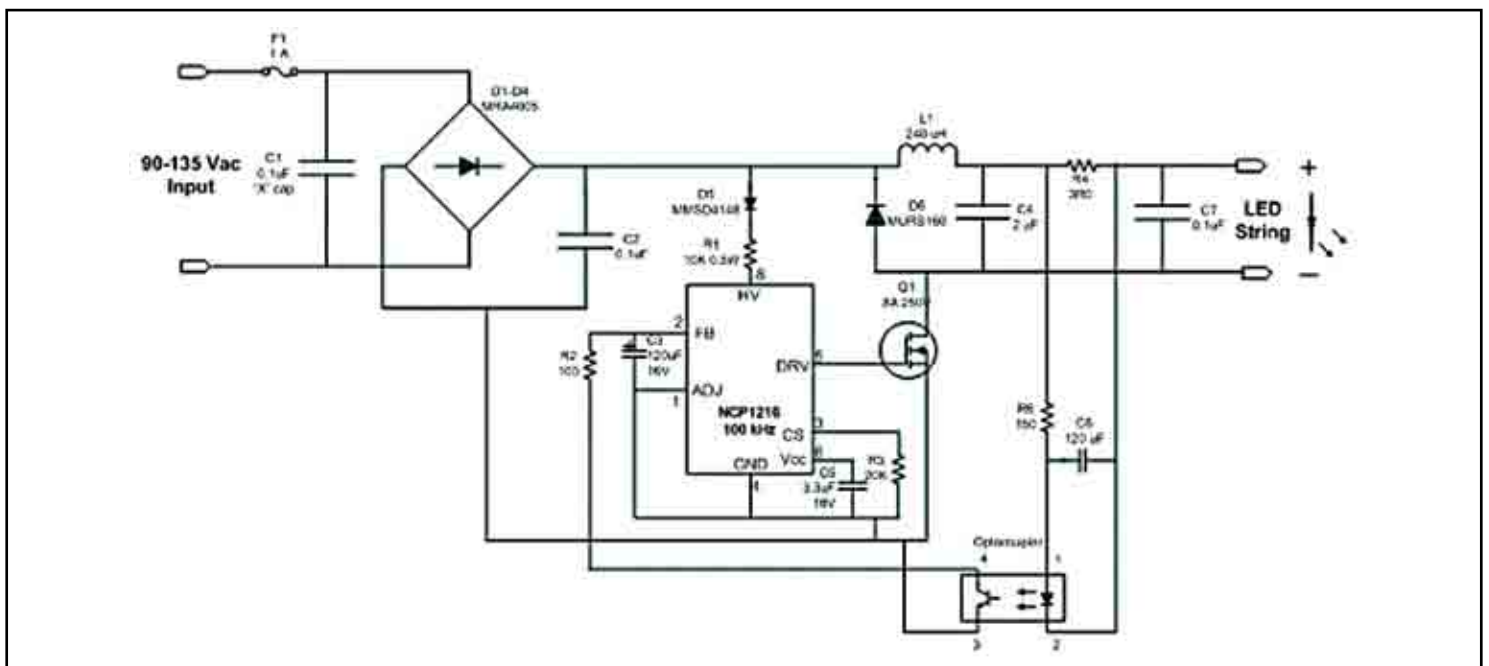

Figure 1 Circuit Schematic for 115 Vac, 350mA Configuration

The schematic shows the most basic implementation of the non-isolated converter circuit. Those experienced in power conversion technology will recognize this as a simple buck converter in which the AC mains voltage is rectified (via D1 through D4) and then converted to a lower voltage by the buck circuit composed of inductor L1, MOSFET switch Q1, output capacitor C4, and controller. In this specific implementation for 90 to 135 Vac input, a simple feedback circuit consisting of parallel current sense resistors R4, the integrating network R6 and C6, and the optocoupler allow the circuit to operate in a constant current output mode. Normally, an optocoupler is not required in a non-isolated design, but in this case it is used to level shift the current sense signal present at the top of the LED string. The specific implementation of this circuit allows it to provide high power factor as well as a constant current. The buck input capacitor C2, sometimes referred as the "bulk" capacitor, must have a high reactance to the 120 Hz, full-wave rectified waveform presented by the input bridge rectifier circuit; otherwise the power factor would be substantially degraded as is typical with a capacitive input filter. A typical value for this capacitor would be in the range of 0.1  $\mu$ F to 0.47  $\mu$ F depending on the desired output power level of the circuit.

The inductor L1 is designed such that its inductance is sufficiently low that the buck converter operates in the discontinuous conduction mode. This condition is essential for high power factor in this circuit. This means that during the switch off-time, the energy stored in the inductor will go to zero and the current flowing through it will cease prior to the turn-on of Q1 for the next switching cycle. It is more common to operate a buck converter in continuous conduction mode such that the freewheeling diode D6 is always conducts when Q1 is off and the current never goes to zero in the inductor. This latter mode requires a higher inductance for L1, however, the current ripple component in the choke can be made very low, thus facilitating minimal capacitive filtering at the output via C4. The value of C4 in the discontinuous mode can also be very small because it is only necessary to filter out the high frequency switching component of the current waveform. The output ripple waveform profile presented to the LED load is a reduced version of the 120 Hz pulsating dc present at the input of the buck converter. A typical value for C4 is 1 to 5  $\mu$ F and should be implemented with a low ESR film (polypropylene) capacitor.

The NCP1216 controller is implemented such that the duty cycle or pulse width of the MOSFET is controlled by the feedback signal presented on pin 2 from the optocoupler. Resistor R3 sets up the controller to run specifically in a conventional PWM mode as opposed to the current mode. The feedback signal is integrated by the R/C network of R6/C6 such that the average DC value of the 120 Hz waveform is used as a feedback signal. This network forms a low frequency pole at about 10 Hz and, as such that the optocoupler does not respond to the 120 Hz envelope of the output ripple. The end result is an essentially constant on-time for the MOSFET during its switching cycles. This low bandwidth, closed loop condition is also necessary for high power factor. As a consequence of the circuit operations described, the input impedance to the buck converter looks purely resistive, and as a result, the input

mains current envelope follows the input voltage envelope and the power factor approaches unity. At the same time the controller maintains an average output current independent of line voltage or LED forward voltage drop thus providing a regulated, constant average current to the LED load. The gain of the current loop is a function of the optocoupler current transfer function slope and is adequate for typical constant current operation of LED loads.

This circuit configuration does have some limitations. The maximum series LED forward voltage ( $V_f$  max) is a function of the minimum AC input voltage, the output capacitance (C4), and the maximum duty cycle of the NCP1216. This value can be approximated by the following simple relationship:  $V_f$  max (dc) = 0.55 Vac in min. So for a 90 to 135 Vac input this would result in a  $V_f$  max = 0.55 x 90 = 49.5 Vdc if constant light output was desired down to the brownout condition. If  $V_f$  is much larger than this value the output will start showing current droop. In addition, to achieve good power factor, the current through the inductor must be discontinuous which results establishing a lower limit to the number of LEDs. The optimum inductor value will vary with the line voltage and the total series  $V_f$  of the LED lamp string. Testing has shown that the following inductance values are adequate for most off-line applications assuming typical line variations, and an LED  $V_f$  from maximum to about 50% of the  $V_f$  max. For an input range of 90-135 Vac, the range of inductor value for a 350mA average LED current is 220-250  $\mu$ H. For an input range of 190-285 Vac, the range of inductor value for a 350mA average LED current is 390-470  $\mu$ H based on a 100 kHz switching frequency of the PWM controller. Figure 2 and 3 illustrate the power factor and current regulation performance under nominal operating conditions.

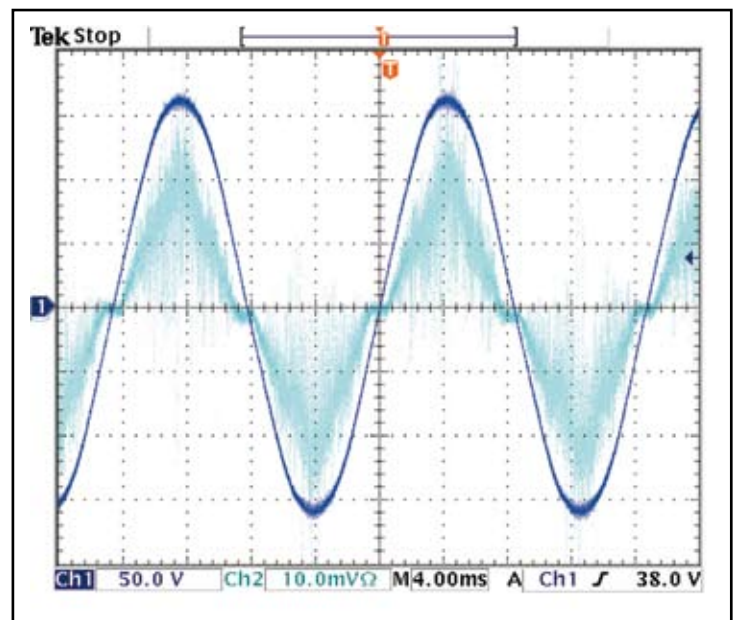

Figure 2 – Input Voltage and Current Waveforms  $V_{in} = 115$  Vac,  $V_f = 31$ V,  $I_{out} = 350$ mA nom

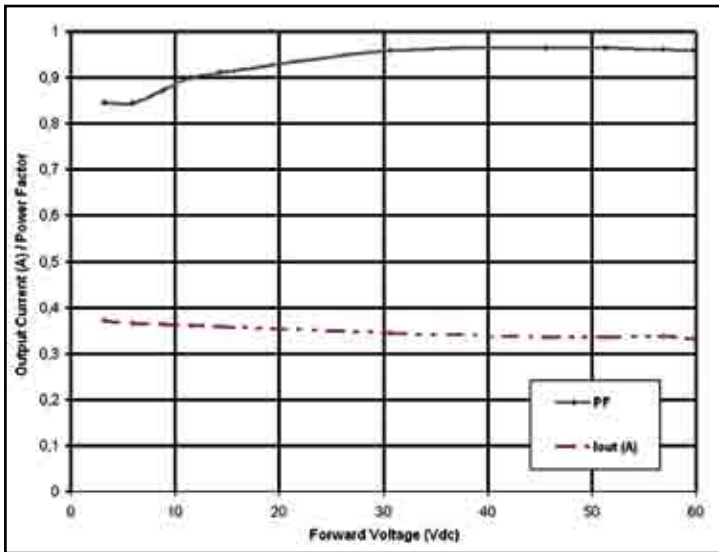



Figure 3 - Power Factor and Current Regulation versus LED Forward Voltage ( $V_{in} = 115 \text{ Vac}$ )

## Conclusion

As has been illustrated, a high power factor single stage LED driver circuit has been developed which is optimized for driving arrays of LEDs. While this example showed the circuit operation for a 115 Vac mains application, the circuit can be modified for 230 Vac or 277 Vac by making minor changes to the components to support the increased operating voltage and change the inductor value to assure discontinuous operation. For 230 Vac operation, the number of LEDs that this circuit can drive would also double allowing more LEDs to be powered from a single driver.

The use of LED arrays in Area Lighting applications is starting to gain traction around the globe with numerous trials and small scale deployments taking place. Many government bodies are already familiar with the benefits of LED technology as seen by the wide deployment in traffic signals so they recognize the value of long life products that do not require the same level of maintenance cost. There are hurdles that need to be addressed concerning total cost of ownership as well as regula-

tory and logistical considerations. For example, most public area lamps are not metered and depending on how they are administered, a local utility will have a tariff system in place where the city is charged based on the number and type of lamps used. In addition, the maintenance and upkeep may also be outsourced or city-managed. As a result the economic benefit analysis and decision making process can become quite complex. Today the economic benefit and power saving from LED area lighting is highly dependent on the type of lights being replaced and the end use. For example the city of Raleigh, North Carolina recently replaced 140 120W High Pressure Sodium lamps in a parking structure with LED fixtures and they were able to reduce energy consumption by 40% while virtually eliminating annual maintenance cost. This can only become more attractive as LED performance continues to advance both in light output, efficacy, and cost. Clearly, in the next few years we will see more deployments of LEDs for Area Lighting applications especially in lower power lighting applications where fewer LEDs are required and the light output can be tailored to the specific needs of the end application. For these applications, the driver circuitry must be optimized to meet the electrical and regulatory requirements, be scalable to address the diversity of LED configurations and achieve the cost targets for widespread deployment. ■



**POWER VECTOR IS: ENGINEERED LED POWER**

Our Team of engineers, designers, and software specialists has a history of delivering innovative and effective power solutions. Power Vector's 3-IN-1 IRIS LED Driver Dimmer™ combines Power Isolation DMX512A Interface, and up to 8 Configurable Channels for driving and dimming ANY high brightness LEDs.

- 86 Watts
- Ideal for any High Brightness LEDs from 350mA up to 1.5A
- Class 2 Outputs
- USITT DMX512A Compatible
- Power Vector's Unique Dimming Method, used in all our products

Coming soon, Power Vector's TRINITY LED Driver Dimmer™.

**3 IN 1 LED DRIVER DIMMERS**

Power Isolation

DMX Interface

Current Drivers



**PUZZLE SOLVED**

Have a look at our website [www.powervector.com](http://www.powervector.com).  
For more information call 1-888-LED-3IN1(533-3461)  
or email to [info@powervector.com](mailto:info@powervector.com).

# Innovative Analog Control Technologies for Mainstream LED Lighting Market

> Andy Aaron and Jeanette Jackson,  
Light-Based Technologies Incorporated

The lighting industry commonly applies digital technologies to control light-emitting diodes (LEDs) even though analog methods are superior in many ways. Controlling light-emitting diodes (LEDs) includes managing the brightness, color and temperature of LEDs for a variety of illumination applications. New analog techniques such as that used by Light-Based Technologies' (LBT) LB3CSA1 application specific integrated circuit (ASIC) are entering the mainstream LED lighting market proving a viable alternative to pulse-width modulation (PWM) and other digital LED control technologies.

## Benefits of Analog LED Control Technologies

Simplicity, intelligence and cost-effectiveness are key benefits to using pure analog components in LED product designs. In addition, they are able to overcome many of the inherent challenges of digital LED control technologies.

### Simplicity

Analog control functions simplify the design and engineering process for LED products and applications. LEDs are generally analog in nature where particular consideration should be given to their narrow control margin. It seems reasonable then to assume that controlling LEDs with intelligent analog solutions streamlines the entire LED control process by removing the analog-to-digital (A-D) and digital-to-analog (D-A) converters applied in digital systems. Pure analog also simplifies the ability to control brightness, polarity, color and cycle with one small package. The LB3CSA1 8 pin ASIC allows all of these control functions with just two variable inputs such as variable resistors (VRs). This single ASIC provides all information required to control brightness and color mix to any LED assembly without additional complex microprocessors or components.

### Intelligence

Analog control for LEDs offers an unprecedented intelligence to the LED industry. The analog information generated by the LB3CSA1 represents an infinite number of colors within a single grayscale range of control. In other words, a single electrical input value correlates to a complete color value anywhere within the analog color gamut.

Digital is by definition limited to discrete numbers representing a control limitation of 16,777,216 colors (based on current 3x8 bit D-A conversion). As shown in Figure 1, there is no opportunity for mid-PWM or mid-ON/OFF selection. Alternatively, the LB3CSA1 analog solution offers a manageable infinite resolve of color spectrum information limited

only by electronic measurement principles. Infinite resolve becomes crucial for high speed, high resolution LED presentations, as well as compact, efficient regeneration of data or computation of mathematics.

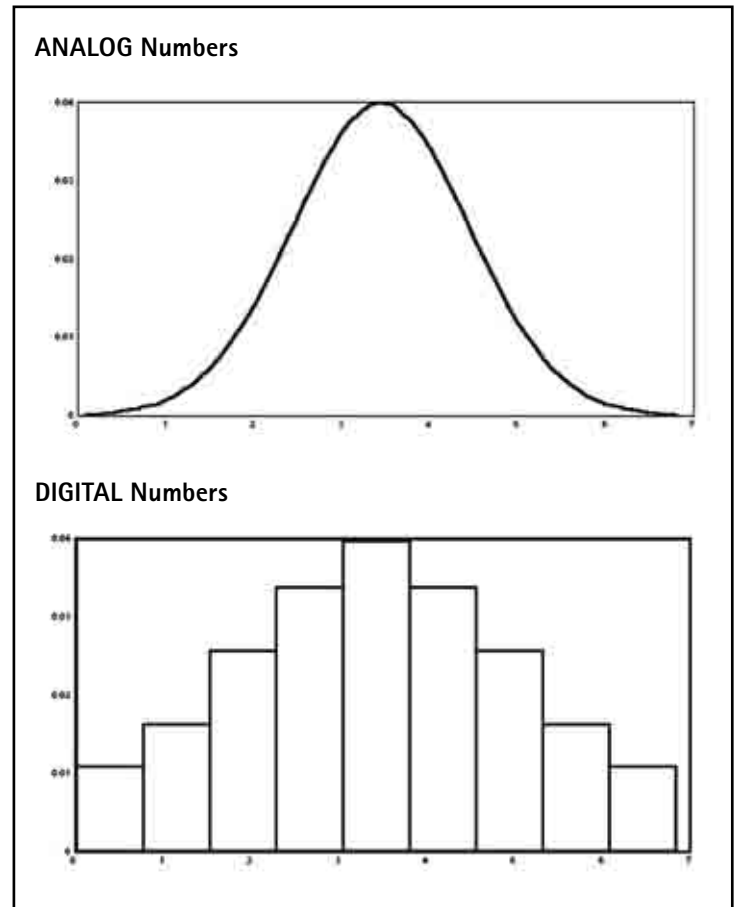

Figure 1: Analogue and Digital Number Comparison

### Cost-Effective

Emerging analog techniques are a cost-effective, self-intelligent alternative to energy-hungry digital methods of LED control while still maintaining a magnitude order gain of function and performance. This justifies argument that high-performance analog technologies are superior.

One example of a cost-effective analog control component is the LB3CSA1, which is available for the same cost or less than digital 8 pin packages yet carries all of the added benefits of analog resolve. Cost decreases in relation to potential because analog concepts provide an unrestricted framework and great economies of scale for design engineers to apply to product developments. By employing analog solutions, companies can now offer sophistication, simplicity and performance at mainstream market prices.

## Analog Technologies Overcome Challenges Presented by Digital LED Control

There are several challenges when using a digital means to control LEDs. Complexity, color management, energy consumption, dependability and brightness control lead these concerns. Recent development of analog technologies, including the LB3CSA1 and its associated intellectual property, offer a unique approach to controlling LEDs while simultaneously resolving many of the challenges presented by digital methods.

### Complexity

Until recently, most companies focused on high-speed digital technical developments to control LEDs. This meant that interfacing LEDs to any form of intelligent digital control required many steps of processing and work not required if you choose the right analog technique. One example of a digital control system uses the following list of modules:

1. DMX512 interface hardware and software
2. Individual or grouped microcontrollers with pulse-width modulated outputs
3. A-D and D-A converters (internal or external to the microprocessors)
4. Control and driver interfaces to LED array(s)
5. Series feedback and control loops
6. LED array(s) with associated microcontrollers

The majority of these components are necessary for even the most basic applications with additional microprocessors required to address individual LED pixels.

Analog controls are a simple yet powerful alternative to digital control methods. The LB3CSA1 analog solution removes most of the complexity of a digital LED control system with the following:

1. Simple user interface for input voltage values
2. Control module with one or more LB3CSA1 ASICs depending on the desired application
3. Transistor drivers to the LED array(s)
4. LED array(s)

Analog matrixing techniques are available to provide color motion ("wall wash") effects or display video data through banks or screens of LEDs, respectively, with or without an ASIC at each pixel. These options are further simplified by embedding LB3CSA1 technology into the base of composite red, green, blue (RGB) LEDs. This patented application offers individually addressable two or three pin RGB LEDs: Pin 1 is voltage color set, Pin 2 is a bipolar linear control gate and Pin 3 is ground.

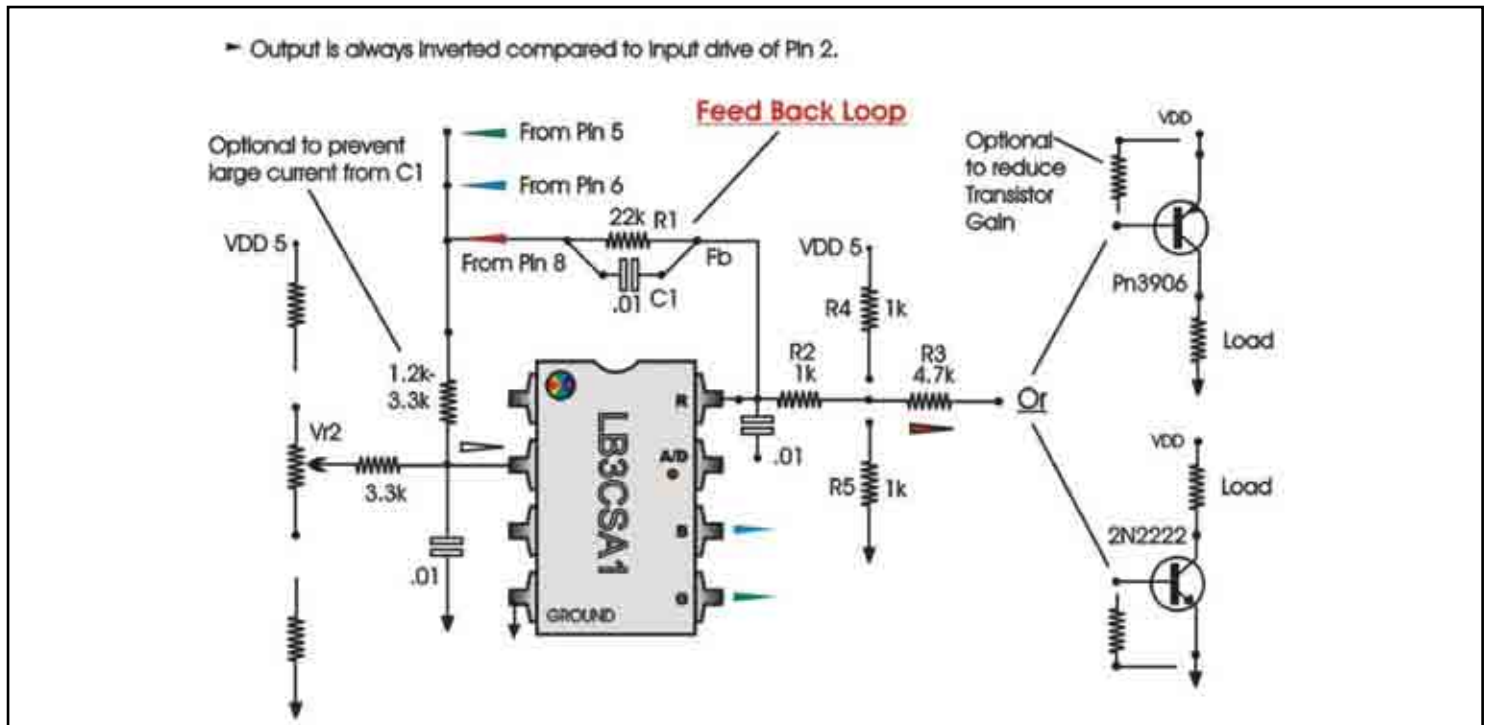

Figure 2: Analog Feedback Loop

Notes: (1) Greater resolution of Pin 2 to output relationship is available by placing a smaller VR value in between or at either end of a voltage divider. (2) Option is available to wire as color select for analog tuning. (3) If the output is connected to top and bottom rails at the same time, the output will float at center when Gate is center. The output will begin to push or pull hi or low from the center versus the normal full rail to rail sink and source.

## Color Management and Correction

Both analog and digital technologies rely on the manufacturers binning process to minimize color variations in LED products. From there, it is up to the control module of the LED device to manage color temperatures, and correct the color and brightness of the LED array to match the users desired end result.

Digital control technologies such as PWM require more work than analog technologies to perform color management and correction functions. Digital techniques require optical and electrical feedback loops in connection with the control module via a series of processors and filters to begin the color management and correction process. Since these practices are relatively new, there are still many challenges to overcome such as the need for high speed pulse width to accommodate any real time, or close to real time, activities.

As shown in Figure 2, analog color management and correction technologies using the LB3CSA1 are simple. In this example, the output load level is sent as positive or negative feedback and is inverted by gate Pin 2 via a photo transistor, CDS cell or wire. This technique allows color levels to be direct and self-correcting since the outputs are fed back to adjust the drive current in real time. This provides constant correction for wear on the load to maintain consistent output throughout the LED device.

Feedback values can be taken from any output location as long as the value is inverted. To assist in balancing the response of each channel to suit the color temperature and speed and to equalize different loads on the channels, specific resistor (R) 1 and capacitor (C) 1 values can be applied to provide unique filters with alternate pass and rejection properties. Additional benefits of this analog color management and correction technique includes:

1. Reduced gain bursts from input over modulation
2. Reduced over sensitivity under light load conditions
3. Reduced distortion during linear modulation of Pin 2
4. Reduced oscillations that can occur when light loads are half way ON or floating OFF

## Energy Consumption

Digital technologies are used for most information and communication applications around the world. The fact is digital technologies are limited by the number of 0-1 combinations used to perform a specific function within a reasonable time frame. Furthermore, power and energy consumption to process all of the 0-1 combinations required to execute complex functions becomes excessive.

Energy consumption associated to LED control is minimized when analog concepts are employed. Series of digital 0-1 values are replaced by single analog values in the form of voltages or other contemplated analog numbers. With these numbers, the LB3CSA1 module automatically regenerates the color information to be displayed or distributed with no

digital assembly required. For example, to display a select color on a single pixel, a digital processor is instructed to create and send 24 bits of 0-1 data to the assigned pixel's microprocessor. There, the 24 bits of information are processed, sent through D-A converters and displayed on the LED array. Alternatively, the LB3CSA1 uses a single analog number to provide the same 24 bit color information direct to the LED array without any microprocessing. This illustrates a relative energy consumption of 1/24th.

In addition to operational time and energy savings, there is minimal heat dissipation as a direct result of less work and resistance in the process. There are also unique analog addressing techniques available that enable one LB3CSA1 ASIC to provide all of the information required to control an entire series or screen of LEDs without a microprocessor at each pixel. Collectively, these techniques and applications represent a high efficiency analog information processing and display device.

## Dependability

Developing reliable control systems is essential for a business to prosper in the LED lighting industry. As noted above, digital techniques tend to be complex and hard driven providing more opportunity to break down over the life of the product. Using analog methods reduces heat, time and associated work cycles of components, consequently there is less concern for reliability issues. Analog techniques also use fewer components in product development allowing companies to apply cost of product to quality rather than quantity of components.

The LB3CSA1 ASIC and associated IP is an ideal solution for a dependable control system because it offers constant current, static control and slow start options when driving the LEDs. Analog principles, also known as "smooth varying" technologies, take the physical properties of continuous linear or non-linear values. This includes voltages and light intensities that characteristically transition in an analog nature. To get steady, flicker free performance from PWM controllers, extremely high speed processors are used to signal the LED to turn ON and OFF fast enough to appear ON continuously. With this solution, LEDs can be signaled as slow as 30 times a second without a visual flicker effect. Some Engineers argue that turning an LED ON and OFF at such high speeds can be damaging, negating key benefits of long lasting, quality solutions when applying LEDs in mainstream lighting products.

## Brightness Control

Brightness control is another challenge when using digital technologies to drive LEDs. At present, for independent brightness control, most companies enable supplementary ICs to interface to microprocessors in the control system, or have pulse-width modulation techniques built into the microprocessors. The LB3CSA1 has streamlined brightness control into the same package as color and information control. With a simple variable resistor (VR) or other single wire mechanism, users can select the brightness setting (either polarity) with no other processing or complex parts.



## LB3CSA1 ASIC and Intellectual Property

LBT has developed several analog technologies to provide simple, cost-effective alternatives to digital processes. The LB3CSA1 ASIC is one variation of this technology that expands into the lighting and information technology (IT) industries, and demonstrates a truly energy efficient, intelligent alternative to common digital practices.

## LB3CSA1 Product Specification

The LB3CSA1 is a direct voltage/current to preset three phase voltage/current converter. It allows users to input analog (direct current) DC and/or alternating current (AC) voltage to resolve a controlled mix of linear current outputs. The three analog outputs are arranged to represent all elements of an analog color light spectrum.

In LED control applications, the outputs control devices such as RGB or white LEDs for phased color mixing, single color positioning and brightness control. This includes static color select, continuous color select and continuous cycle settings, all controlled with a low voltage input. The output arrangement can be modified to suit hundreds of design applications, including the option of increasing or decreasing the number of phases for unique output structures.

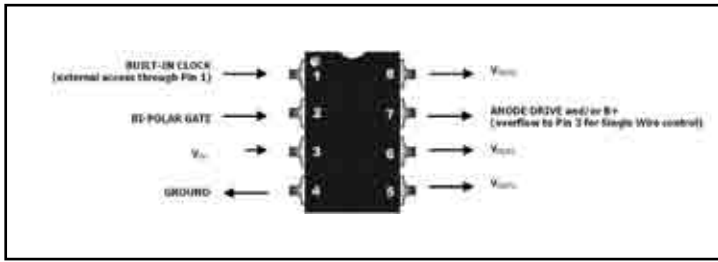

Figure 3: LB3CSA1 Pin Layout

## LB3CSA1 Inputs and Outputs

The LB3CSA1 enables direct, open-ended interfacing to a variety of inputs and outputs. The pin layout for the ASIC is shown in Figure 3.

Pin 1 is a self-contained RC clock for a 1-2-3 (or RGB output as decoded) using standard decimal counting principles. It supplies the source clock signal count and can receive a digital clock trigger for output demodulation functions such as 1-2-3 tracking or chasing applications. Pin 2, the bi-polar gate, is the current or luminous control and allows both polarities to be manipulated with a simple VR value.

The LB3CSA1 has two modes selectable at Pin 3: (1) Linear Mix Select from 0.0 to 2.4 volts and (2) Continuous Cycle at 2.5 volts, at which point Pin 1 clock is activated. Figure 4 outlines the correlation between 0 to 2.4 input voltages and the phased output among the three variables.

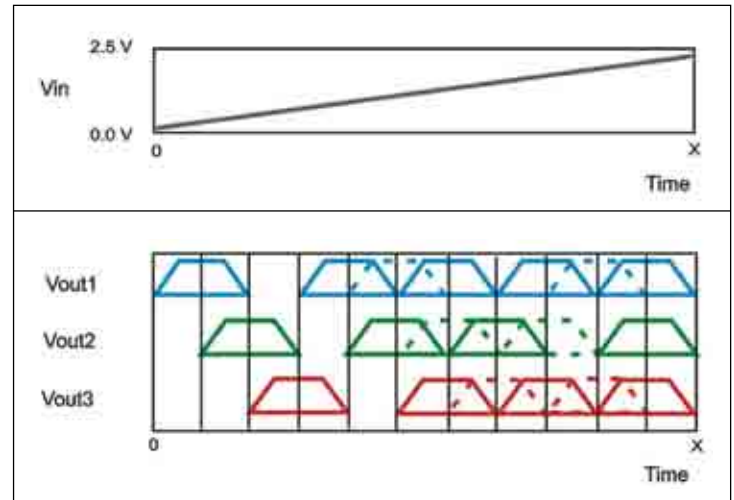

Figure 4: LB3CSA1 Input to Output Relationship

Generally, the LB3CSA1 can interface to any input signal from any technology. Some common applications include audio, optical, video and microcontroller input direct to Pin 3. This also includes electrical values such as:

- Direct Current/Voltage
- Digital/Analogue Converter
- Frequency/Voltage
- Alternating Current
- Photo Electronics
- Photo Resistors
- Variable Resistor
- Pulsating Direct Current
- Modulated Analogue

There are several output interface circuits that enable the LB3CSA1 to drive a variety of loads, including RGB and white LEDs, matrix displays, fiber optics, neon tubes, incandescent light bulbs and more. Collectively, these input and output interface circuits enable users to create truly innovative products for the lighting and IT industries.

## Increasing Drive Current

The LB3CSA1 outputs 20 mA per channel. There are many ways to increase current for higher power applications. Figure 5 outlines a MOS-FET transistor interface with approximately 2.5 amps of current. Other options include 150 mA, 350 mA or other mA drive interfacing values depending on the needs of your application.

### Notes:

- (1) After 2.4 volts the ASIC sets to continuously cycle through the outputs
- (2)  $V_{OUT1}$  is available in different arrangements and quantities
- (3)  $V_{IN}$  can be set with a static resistor value (speed and brightness can be set via Pin 1 and Pin 2)
- (4) Input and output waveforms can vary to suit desired function
- (5)  $V_{OUT1}$ ,  $V_{OUT2}$  and  $V_{OUT3}$  are separated for clarity

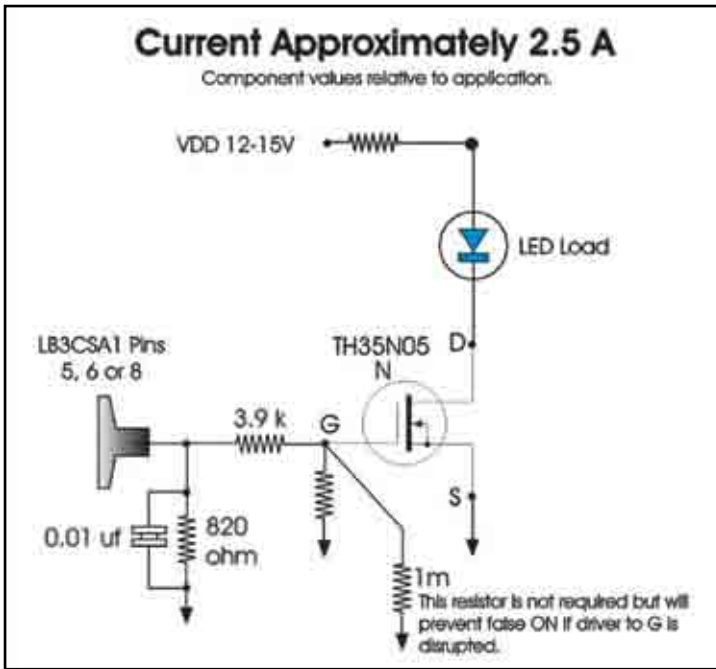

Figure 5: MOSFET Interface to LB3CSA1

## Size

Designers are discovering the compact space advantage offered by this analog technology. The LB3CSA1 is an 8 pin package to fit any functional layout, and is available as a die, SOP8, DIP8, MSOP8 or QFN8 package. The LB3CSA1 requires minimal peripheral hardware to provide all of its performance features.

## LB3CSA1 Performance Features

LEDs have been applied in machine vision and indication applications for years. Today, they are redefining the illumination industry as a reliable, smart alternative to traditional forms of lighting. The features associated with the LB3CSA1 include:

- Pure analogue, therefore seamless, multiphase information generation technology
- Built-in clock with up to 1 megahertz (MHz) cycle speed
- Direct, open-ended interfacing to all forms of analog (and digital) technologies
- Integrated full-spectrum color and cycle select, speed control and brightness control
- Single wire, single value data regeneration for information communication infrastructure

These features make the LB3CSA1 ideal for thousands of intelligent LED applications including direct sensor to color indication with motion, temperature and light; audio modulation for cellular, MP3 and other similar devices; color and brightness control for backlighting, signage and general lighting applications; cost-effective solution for innovative

consumer level products such as RGB string lights; and simplified video display technologies where LEDs are the light source for each pixel. There is also great opportunity to revolutionize LEDs by offering a two or three pin composite RGB LED with color select, control gate and ground in place of the existing four pin structure. This would minimize copper wire consumption and eliminate microprocessors currently used to do the job.

## Continuing Innovation

To complement the innovative control technologies, LBT has developed a new high-efficiency LED driver. This innovation offers expansion of series LED arrangements without the need for series-parallel techniques or concern for voltage drop due to the increase in length. In fact, this technology enables engineers to drive a large quantity (up to 1000) of LEDs or other solid-state devices in continuous series arrangements with any reasonable desired supply voltage from 12 volts AC and up. The benefits of these new drivers include:

Safe – low voltage supply module with all of the benefits of a high voltage, plug-in lighting system

- Energy efficient – current draw minimized to a single element on the load plus the supply itself
- Energy Star – practically zero current draw unless load is applied
- Heat dissipation – minimal to no heat dissipation
- Cost-Effective – price directly related to size, quality and performance

The most recent application in production phase is a white LED MR16 bulb that offers high performance (lumens/watt) and efficiency (low mA draw) for the general white light market.

## Conclusion

The LB3CSA1 and associated IP is a revolutionary analog alternative to complex digital LED control technologies. This approach removes problems associated with digital techniques with one simple, intelligent and cost-effective solution. ■

## Solving high-voltage off-line HB-LED constant-current control-circuit issues

> Giovanni Carraro, International Rectifier

HB-LED (high-brightness light-emitting diode) use is on the rise in a growing list of applications. Driving their acceptance is an impressive list of attributes attractive to OEMs and end users alike. HB-LED's combination of high efficiency, small size, and safe low-voltage operation open opportunities for more flexible designs than traditional lighting devices. The lamps exhibit excellent cold weather performance, superior color gamut and brightness, and excellent operating life. They are also free of mercury—a growing advantage as environmental concerns push the lighting industry toward cleaner technologies.

However, with LED per-package wattages and operating currents having reached 5 W and 1.5 A, respectively, the devices' large manufacturing tolerances (Table 1) reveal that traditional control methods, such as resistive current limiting, are neither sufficiently accurate nor efficient. New circuits address the need for accurate and efficient current control

and, in some cases, economically provide useful features that simplify the application-level design.

Luxeon III	VF (V) @ 25°C			VF variation	VF Tempco (mV/°C)
	Min	Typ	Max		
White, Green, Blue	3,03	3,7	4,47	19,50%	-2
	@0.7A	@0.7A	@0.7A		
Red, Amber	2,31	2,95	3,51	20,30%	-2
	@1.4A	@1.4A	@1.4A		

Table1: Example of LED forward voltage variations

### String theory

HB-LED's brightness and color are both functions of forward current. To ensure that each HB-LED in a string produces the same light output, connect them in series. This arrangement, however, requires a current-control circuit with a large compliance voltage. Parallel connections yield poor results owing to the steepness of the HB-LED's IV curve,

**Light-Based Technologies**  
Simplify your designs with intelligent, cost-effective analog LED control and driver technologies.

**Intellectual Property**  
Unique portfolio of technologies, product designs and application techniques for the lighting and information technology industries.

**LBT High-Efficiency LED Driver**

- Current draw minimized to a single element on the load + supply
- Practically zero current draw unless load is applied
- Minimal to no heat dissipation
- No series-parallel arrangements required (12VAC can run more than 30 white LEDs at 20 mA in Series only)

\* Applications include LED replacement bulbs, SSL products, signage, matrix displays, and more.

**LB3CSA1 LED Control ASIC**

- Analog infinite resolve technology in three phase output format
- Built-in color, cycling, overlap, speed and brightness control
- Open-ended interfacing to all input sources and output loads
- Suitable for hundreds of design applications

\* Applications include RGB and white LED control, sensory and indication lighting, IT, and more.

Toll Free: (800) 875-0170 (North America)  
Global: (604) 939-4957  
Email: [info@lightbasedtechnologies.com](mailto:info@lightbasedtechnologies.com)  
[www.lightbasedtechnologies.com](http://www.lightbasedtechnologies.com)

## LED Test and Measurement



Measure all optical and electrical parameters of single LEDs, high-power LEDs and LED modules in conformity to international standards accurately and within seconds. With equipment from INSTRUMENT SYSTEMS – the world leader in LED metrology.

- Luminous intensity (candela)
- Luminous flux (lumen)
- Dominant wavelength (nm)
- Color coordinates (x, y, z)
- Spatial radiation pattern
- Thermal behavior



**INSTRUMENT SYSTEMS**  
LIGHT MEASUREMENT

phone +49 89 45 49 43-0  
[info@instrumentsystems.de](mailto:info@instrumentsystems.de)  
[www.instrumentsystems.de](http://www.instrumentsystems.de)

**WE BRING QUALITY TO LIGHT**

manufacturing tolerances that affect  $V_F$  (the forward voltage), and  $V_F$ 's drift over temperature. For example, the  $V_F$  of Lumiled's Luxeon III might vary from part to part by as much as 20% (Table 1).

Drivers for series-connected HB-LED strings must maintain constant average load current despite changes in the lamp's electrical parameters, such as temperature related drifts. A small sense resistor in series with the HB-LED provides continuous feedback of the string current.

A ground-referenced sense resistor simplifies the current-sense circuitry but requires a high-voltage driver in the buck converter. To avoid isolation transformers a design must choose either high-side sensing and a low-voltage driver or low-side sensing and a high-voltage driver. An effective method to achieve the latter is to use a high-voltage buck-converter driver with time-delayed hysteretic control (Figure 1)

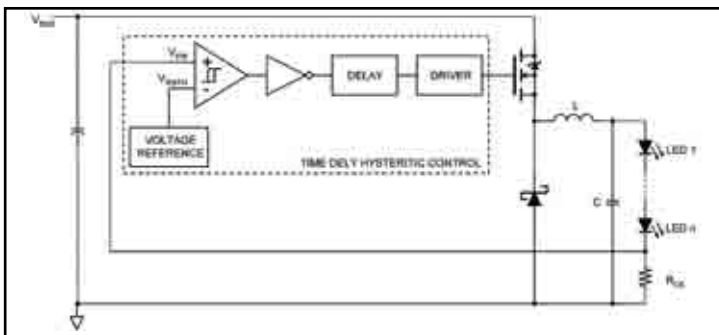

Figure 1: Time-delay hysteretic-control circuit block diagram..

## Keep current

This circuit's controller regulates the output current by comparing the feedback voltage,  $V_{IFB}$ , to a nominal 0.5 V internal reference,  $V_{IFBTH}$ . When  $V_{IFB}$  is below  $V_{IFBTH}$ , the MOSFET is on, powering the HB-LED string from the DC bus. Simultaneously, the LC resonant circuit stores energy while  $V_{IFB}$  increases. When  $V_{IFB}$  reaches the threshold  $V_{IFBTH}$ , the MOSFET turns off after the circuit's intrinsic fixed-time delay.

The delay allows  $V_{IFB}$  to increase beyond the threshold prior to the MOSFET's turn-off. With the MOSFET off, the resonant circuit releases its stored energy, powering the string. During this interval,  $V_{IFB}$  linearly decreases until it reaches the fixed threshold. Though the comparator switches at the threshold crossing, the circuit's delay allows  $V_{IFB}$  to decrease further before turning on the MOSFET and beginning the next cycle.

The result of the fixed time delay and the circuit's consequent continuous switching is that the controller regulates the string current to an average value  $I_{OUT(AVG)}$ , which is the numeric quotient of  $V_{IFBTH}$  (nominally 0.5V) and the sense resistor,  $R_{CS}$ . This relation is valid so long as the LC tank is large enough to maintain sufficiently low ripple—less than 0.1 V.

The regulation method, which exploits the controller's delays to achieve hysteresis, allows the buck converter to operate adaptively as long as the ratio of input to output voltages stays reasonably bounded. Increasing the input-output-voltage ratio increases current ripple. The input voltage and current-limit requirements set the duty cycle. This topology provides continuous and accurate current control independent of both input and HB-LED forward voltage variations.

Figures 2 and 3 and Tables 2 and 3 reflect results this circuit attains while driving two boards of six LUXEON FLOOD 25-0032 HB-LEDs in series at 350 mA and the input voltage in the universal input range of 90 to 265 VAC. Table 2 shows good current regulation over the input-voltage range.

VAC Input (VAC)	Pin (W)	Iin (mA)	Iled (mA)	Vled (V)	LO freq (kHz)	VBUS (V)	Efficiency $\frac{V_{led} I_{led}}{Pin}$
90	14.8	241	340	33.4	200	120	76.7%
120	15.5	207	342	33.4	180	165	73.7%
140	16.1	190	345	33.4	160	190	71.6%
180	17.4	188	348	33.4	137	245	66.8%
220	19	157	356	33.4	115	300	62.6%
265	20.8	150	362	33.4	95	360	58.1%

Table 2: Experimental results with 12 HB-LEDs (two LUXEON flood 25-0032 boards) @ 350. mA Figures 2 and 3 indicate slightly worse ripple for higher input voltages as theory predicts, owing to the correspondingly small duty cycle. This suggests better performance in low mains-voltage regions such as North America and Japan. However, even under the worst-case condition, the controller maintains tight current regulation over the AC input range of 90 to 265 VAC. Additional measurements using one board of six HB-LEDs (Table 3) shows  $\pm 1.3\%$  regulation varying the load voltage from 33.4V to 16.4V.

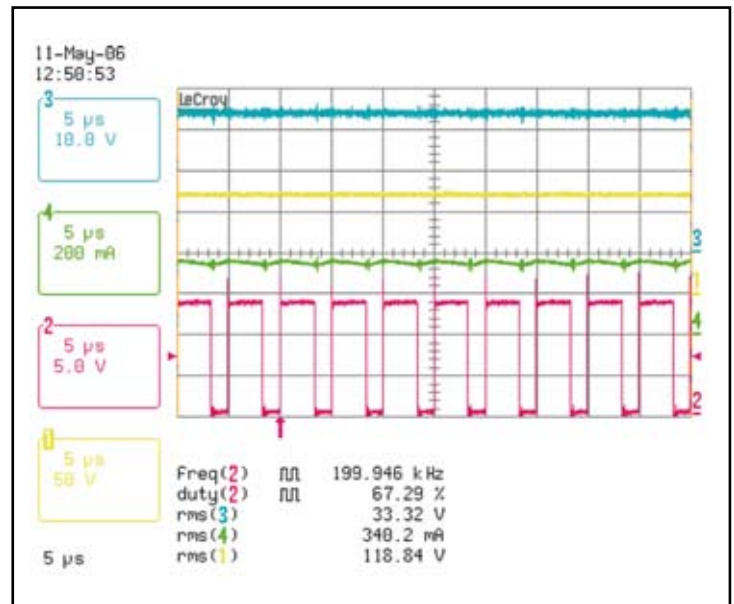

Figure 2: Oscilloscope Images: 12HB-LEDs @ 350mA 90VAC input: Yellow: (CH1) DC-Bus voltage; Red: (CH2) LO pin voltage; Blue: (CH3) HB-LEDs Voltage; Green: (CH4); HB-LEDs Current

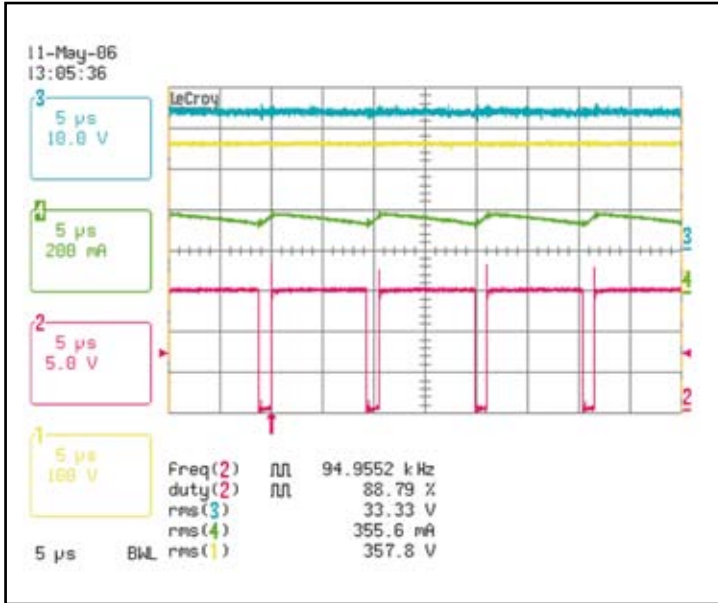

Figure 3: Oscilloscope Images: 12HB-LEDs @ 350mA 265VAC input: Yellow: (CH1) DC-Bus voltage; Red: (CH2) LO pin voltage; Blue: (CH3) HB-LEDs Voltage; Green: (CH4) HB-LEDs Current

The six-HB-LED system was less efficient than the 12-device configuration because this topology's efficiency is an inverse function of the bus-to-output voltage ratio, also illustrated in table 3. The efficiency of the six-HB-LED system can improve, however, by modifying the resonant circuit.

VAC Input (VAC)	Pin (W)	Iin (mA)	Iled (mA)	Vled (V)	LO freq (kHz)	VBUS (V)	Efficiency $\frac{Vled \cdot Iled}{Pin}$
90	14.8	241	340	33.4	200	120	76.7%
120	15.5	207	342	33.4	180	165	73.7%
140	16.1	190	345	33.4	160	190	71.6%
180	17.4	168	348	33.4	137	245	66.8%
220	19	157	356	33.4	115	300	62.6%
265	20.8	150	362	33.4	95	360	58.1%

Table 3: Experimental results with six HB-LEDs (one LUXEON flood 25-0032 board) @ 350 mA

## In synch

Modifying the converter to a synchronous-buck topology improves the circuit's efficiency, particularly for higher load currents and input voltages, with a minimal increase in circuit complexity and cost (Figure 4). Because the bus-to-output voltage ratio sets the buck converter's duty-cycle, the low-side device conducts for most of the switching period in high ratio systems. The MOSFET's  $I^2RDS(on)$  conduction losses are usually small compared to the diode's  $V_I$  dissipation term. However, to properly compare the two topologies, also consider the losses due to the diode's reverse-recovery time compared to that of the MOSFET's body diode.

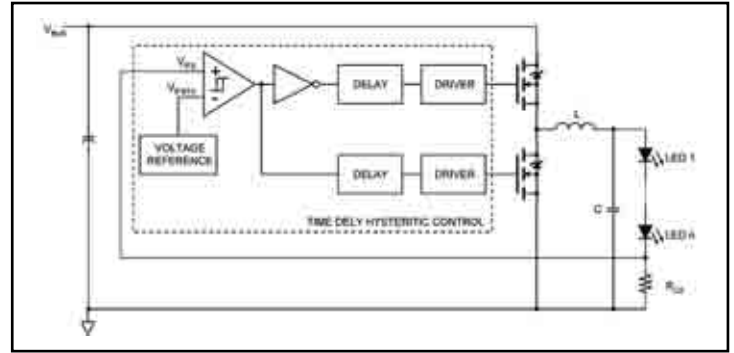

Figure 4: Time Delay Hysteretic Control block diagram circuit implemented in a synchronous buck converter configuration.

When the high-side MOSFET turns on, the common node, VS, rapidly slews from ground to VBUS and the low-side MOSFET or the diode conducts current from VS to ground during the reverse-recovery time. This results in power loss, heating, and component stress to the low-side switching device. The diode's reverse-recovery time is typically much shorter in comparison to the MOSFET's body diode. At low frequencies and load currents, the MOSFET body diode's long recovery time may not be an issue but at high frequencies and currents be sure to compare each topology's total losses through the low-side device to optimize your design.

To mitigate the MOSFET body diode's reverse recovery losses, connect a Schottky diode in parallel with the MOSFET. Due to the difference in the two devices' forward voltages, the inductor will draw its current through the Schottky during the switching deadtime. When the high-side FET turns on, the Schottky's faster reverse-recovery time will dominate the circuit behavior because the body diode will not have been operating in its forward conduction mode. During the low-side conduction interval, however, the MOSFET's low  $RDS(on)$  will ensure low conduction losses.

## References

1. *Limiteds Luxeon III DS45*
2. *K.H. Billings, Switch mode power supply handbook, McGraw Hill, 1989*
3. *O. Ronat, P. Green; International Rectifier, El Segundo, CA; Selecting the Right Driver Topology for an LED System; Intertech LED 2005 Proceedings; Oct.2005*
4. *O. Ronat, P. Green, S.Ragona; International Rectifier, El Segundo, CA; Accurate current control to drive high power LED string; APEC 2006 Proceedings; Mar.2006*

# LED CHINA 2008

— The Toppest Global Event for LED Application



Time: March 4-6, 2008

Venue: Chinese (Guangzhou) Import and Export Fair Pazhou Complex

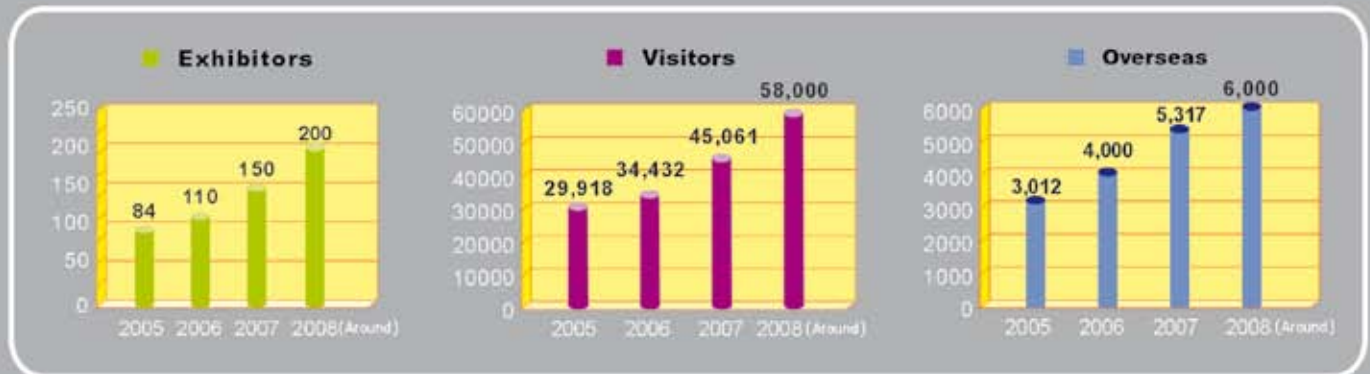

## Preview of LED CHINA 2008

In 2008, LED CHINA, SIGN CHINA and NEON SHOW will be held under the same roof again. The total exhibition area will be up to 50,000 square meters, and LED CHINA area will be more than 10,000 square meters with around 450 standard booths.

## Concurrent Activities

- SIGN CHINA 2008
- NEON SHOW 2008

*www.LEDChina-gz.com*

Contact Details:  
**Trust Exhibition Co., Ltd.**  
 Contact Person: Miss Grace Zhou

Tel : +8620-3810 6261, 3810 6263  
 Fax : +8620-3810 6200  
 Email: LED@TrustExhibition.com



## Sensors

### Improved LED systems with true color sensor

> DI (FH) Fredrik Hailer, MAZeT GmbH

#### Introduction

As a result of the numerous amounts of technical, economical, environmental and design advantages of LEDs versus conventional light sources, LEDs are located in more and more applications like medical engineering, display technology, automotive, interior and exterior lighting or ambient, mood and general lighting. A number of disadvantages exist, though: three of them are the dependency of color and efficiency opposed to temperature, aging and forward current. The heat generation of LEDs in contrast to other light sources is relatively small. However, the temperature range of the application has to be considered. LED systems have to cope with more or less expanded ranges, for example 0°C to 50°C in backlight systems or general in lighting devices. The heat removal is to be done by means of cooling with heat sinks or fans, but they can avoid the warming of LEDs only with high effort. This is similar to the additional use of active cooling elements which cause, in turn, a higher consumption. Not only temperature, also aging and forward current are responsible for the color shift. Brightness can vary up to 20% between LEDs even out of the same charge. Furthermore, the distribution of the dominant wavelength for LEDs of the same type is about  $\pm 8\text{nm}$ , after classification in wavelength groups  $\pm 3\text{nm}$ .

In sum the named factors cause differences for multicolor LEDs visible with the human eye, which can be compensated with color sensors.

#### Functionality of color sensors

The most conventional sensor technology for color sensors is the tristimulus method based on RGB or other spectral filters which are implemented as interference or absorption filters. Color sensors e.g. of MAZeT are based on high-quality interference and XYZ spectral filters which defines that the output values of the detector emulate the tristimulus value function of the human eye (values are defined in the CIE 1931 color space).

After being amplified and digitalized, the three detector signals approximate the tristimulus values XYZ. Compared to spectrometers, color sensors present a cost-effective solution for the measurement and control of illumination. They can be designed with absorption or interference filter in front of a light sensitive detector. Some main characteristics of the several filter types are listed in Table 1 and 2.

Characteristic	Absorption filter	Interference filter
Maximum transmission in the transmission range	Typical Range 60...70%	> 95%
Remaining transmission in the cut-off region	Typical Range 10...20%	< 1%
Temperature stability	Dependant on filter material	Independent from temperature – high temperature stable
Transmission characteristic	Aging due to absorption	Long-term stability without drifts

Table 1: Comparison of absorptions and interference filter.

Filter	RGB	XYZ (True Color)
peak/position/sensitivity	equally shared in VIS based on used filter material	tri-stimulus function - standard observer function (CIE 1931, DIN5033)
interface	red, green blue part of incoming – any status	Yxy, L*u*v' coordinate in color space
applicable for	color teaching and detection	absolute or relative color measurement with an accuracy of $\Delta u'v' < 0,005$ (like human eye)

Table 2: Comparison of RGB and XYZ filter.

The MAZeT XYZ sensor IC MTCSiCS is worldwide the unique color sensor which realizes the tristimulus value function using a combination of photodiode and interference filter. In consequence, the three output voltages of the MTCSiCS present XYZ based values. A comparison of the three resulted filter functions  $x_{\text{MTCSiCS}}(\lambda)$ ,  $y_{\text{MTCSiCS}}(\lambda)$ ,  $z_{\text{MTCSiCS}}(\lambda)$  and of a typical RGB color sensor  $r(\lambda)$ ,  $g(\lambda)$ ,  $b(\lambda)$  is shown in Figure 1.

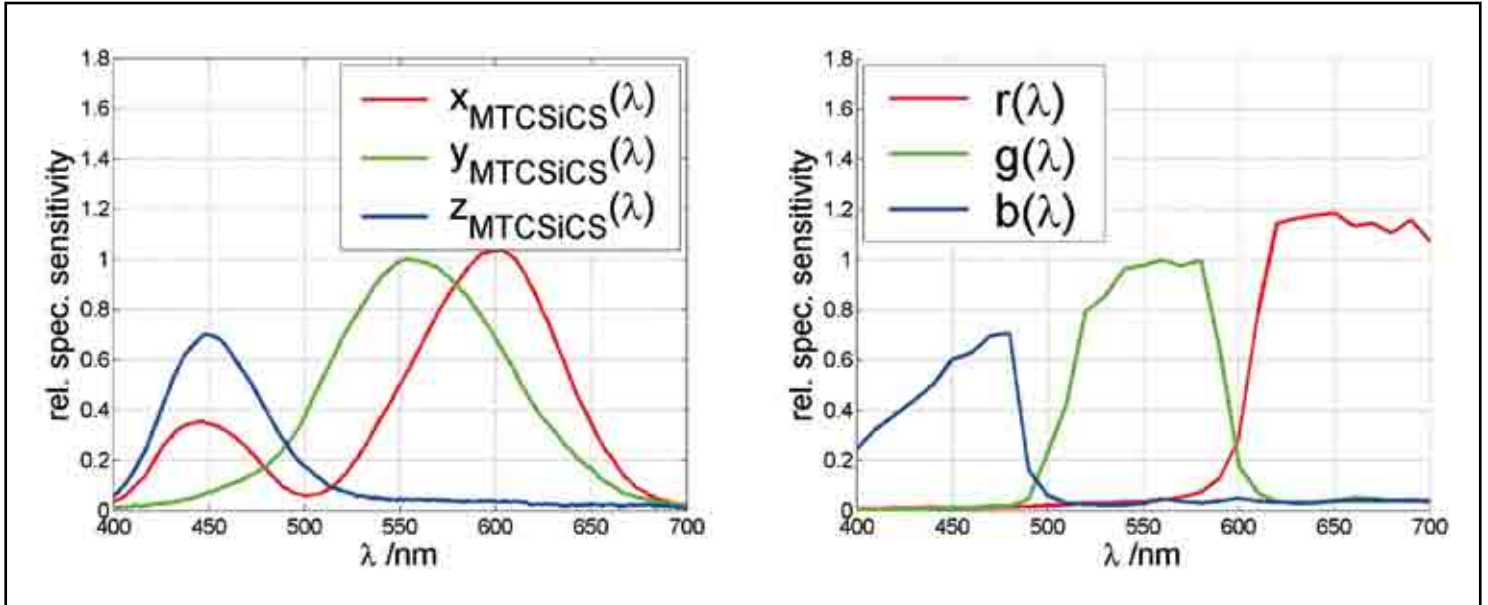

Figure 1: Filter functions of true (left) and RGB (right) color sensors.

Incident light, for example from a multicolor LED (RGB LED), causes a photo current depending on the illuminance of the light source. The following electrical amplification converts the current into voltage

which is digitalized for calibration and signal processing. The software is realized in a microcontroller and/or PC (Figure 2).

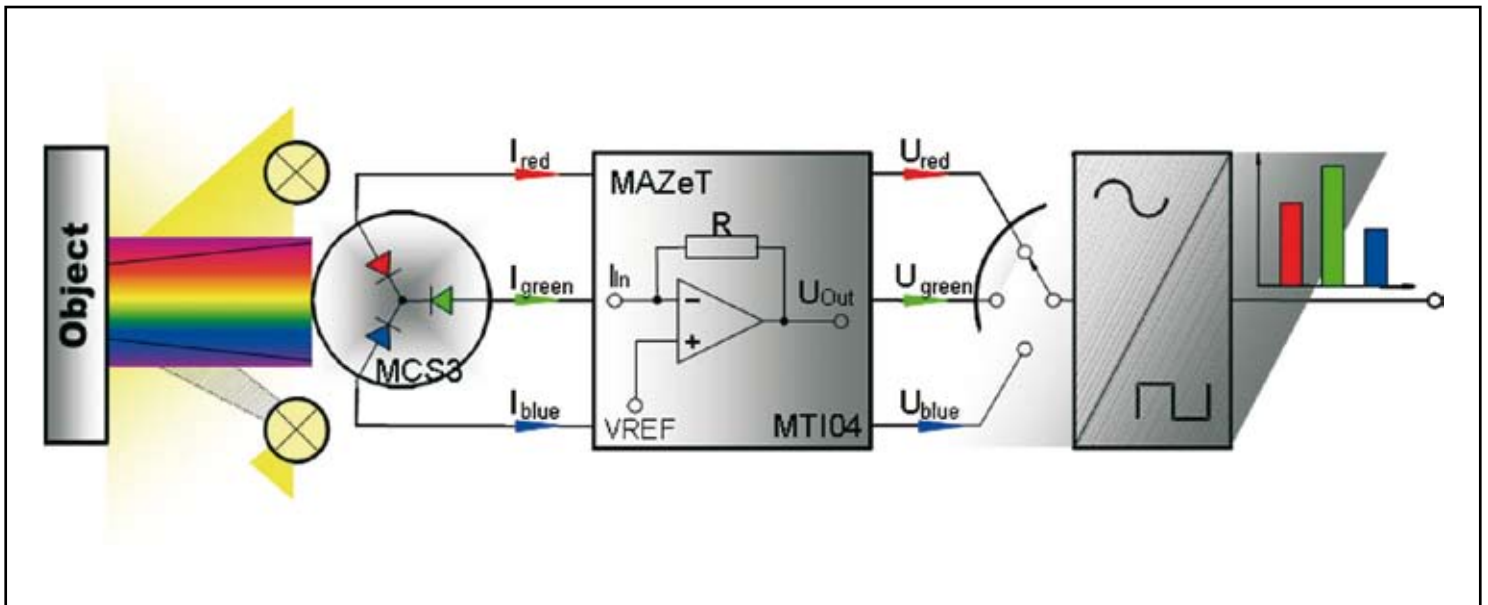

Figure 2: The way from light to XYZ



The resultant XYZ tristimulus values can be computed in other color spaces, for example Yxy or L\*u\*v' CIE 1976, where Y and L\* are measures for the brightness and xy and u\*v' for the chromaticity coordinate. These two color spaces are usually used for self-illuminating targets. Depending on the coloring, the human eye can differ between two colors down to a color difference of  $\Delta u'v' = 0,005$  (for average eyes, trained ones see as different until 0,003) and a brightness of 4%. These values are mainly criteria for the quality and success of color control for RGB LEDs. The following consideration consults the color space L\*u\*v'.

The reference value L\*u\*v'(r) for a color control can be set manual or measured by a second color sensor focused on another LED or display to reproduce it. The actual color of the LED is measured with a color sensor in XYZ and computed to L\*u\*v'(a). According to the difference L\*u\*v'(r) - L\*u\*v'(a), a proportional controller sets the new PWM duty cycles for the red, green and blue LED until L\*u\*v'(r) is reached.

The different color gamut of multicolor LEDs must be subject of particular consideration. Reference values could not be reached if several multicolor LEDs are controlled with a reference value, chosen in border areas of the gamut. In this case, a smaller gamut should be selected.

A possibility other than color sensors is the control by measuring the junction temperature. This method, however, requires the knowledge of the exact behavior of the temperature. Therefore, the luminous flux over temperature must be determined for each LED to compensate the temperature effect during operation mode. Furthermore, aging must be compensated by measuring each LED at a defined temperature and adjust the difference to a reference value. Another disadvantage is the sole use of pulse width modulation controlled LEDs, due to the additional shift of the dominant wavelength according to the forward current, which cannot be controlled by measuring the junction temperature. Table 3 lists some alternatives of color control principles.

Measurement	Advantages	Disadvantages
None	<ul style="list-style-type: none"> <li>• Low cost</li> </ul>	<ul style="list-style-type: none"> <li>• Non constant color point over temperature and aging effects</li> </ul>
Temperature	<ul style="list-style-type: none"> <li>• only one simple thermal sensor</li> <li>• Calculating based on a-priori knowledge of wavelength shift and degreasing of intensity</li> </ul>	<ul style="list-style-type: none"> <li>• No optical measurement</li> <li>• Measurement of parasitic parameter</li> <li>• No detection of aging effects and damage effects</li> <li>• Hysteresis of temperature coupling</li> </ul>
Intensity	<ul style="list-style-type: none"> <li>• Only on simple optical sensor</li> <li>• Calculating based on a-priori knowledge of depending of degreasing of intensity and wavelength shift</li> </ul>	<ul style="list-style-type: none"> <li>• Optical measurement</li> <li>• No color measurement</li> <li>• No detection of aging effects and damage effects</li> </ul>
RGB color	<ul style="list-style-type: none"> <li>• measurement of mixed color effects</li> <li>• Measurement of RGB effects and Intensity of RGB values</li> </ul>	<ul style="list-style-type: none"> <li>• No real color measurement</li> <li>• Worse interpretation of color point two additional sensing channels</li> </ul>
XYZ color	<ul style="list-style-type: none"> <li>• Real measurement of mixed color</li> <li>• Measurement of real color coordinates and brightness</li> </ul>	<ul style="list-style-type: none"> <li>• two additional sensing channels</li> </ul>

Table 3: Measuring methods of color control.

## Calibration

According to the tristimulus method, color sensors are calibrated with the following formula:

$$K = \left( XYZ \cdot X_s Y_s Z_s^T \right) \cdot \left( X_s Y_s Z_s \cdot X_s Y_s Z_s^T \right)^{-1}$$

K: 3x3 correction matrix

XYZ: 3x4 target data

$X_s Y_s Z_s$ : 3x4 sensor data

T: Transpose of matrix

-1: Inverse of matrix

Because of the linear dependency of the basic colors of the used LEDs - in most cases red, green and blue - and their mixed color, it is theoretically sufficient to calibrate the sensor with red, green and blue. However, it is practicable to add white (red, green and blue driven at 100%) in order to reach better results for gray-scale colors. The four colors are measured with color sensor and spectrometer at the same time, while the sensor is placed at its well-defined position in the LED system. Sensor and spectrometer (target) data are inserted in the

above-mentioned formula to compute a 3x3 correction matrix. This procedure is to be done for each color sensor. Later on, the measured sensor values are multiplied with the corresponding correction matrix to get XYZ tristimulus values.

Due to the long-term stability of the used interference filters (see Table 1), the MAZeT MTCSiCS true color sensors have to be calibrated only one time and then never if the conditions in work are not changing.

## Color sensors in LED systems

An example based on the MTCSiCS true color sensor and RGB LEDs is consulted to describe how to install a color sensor in a LED system.

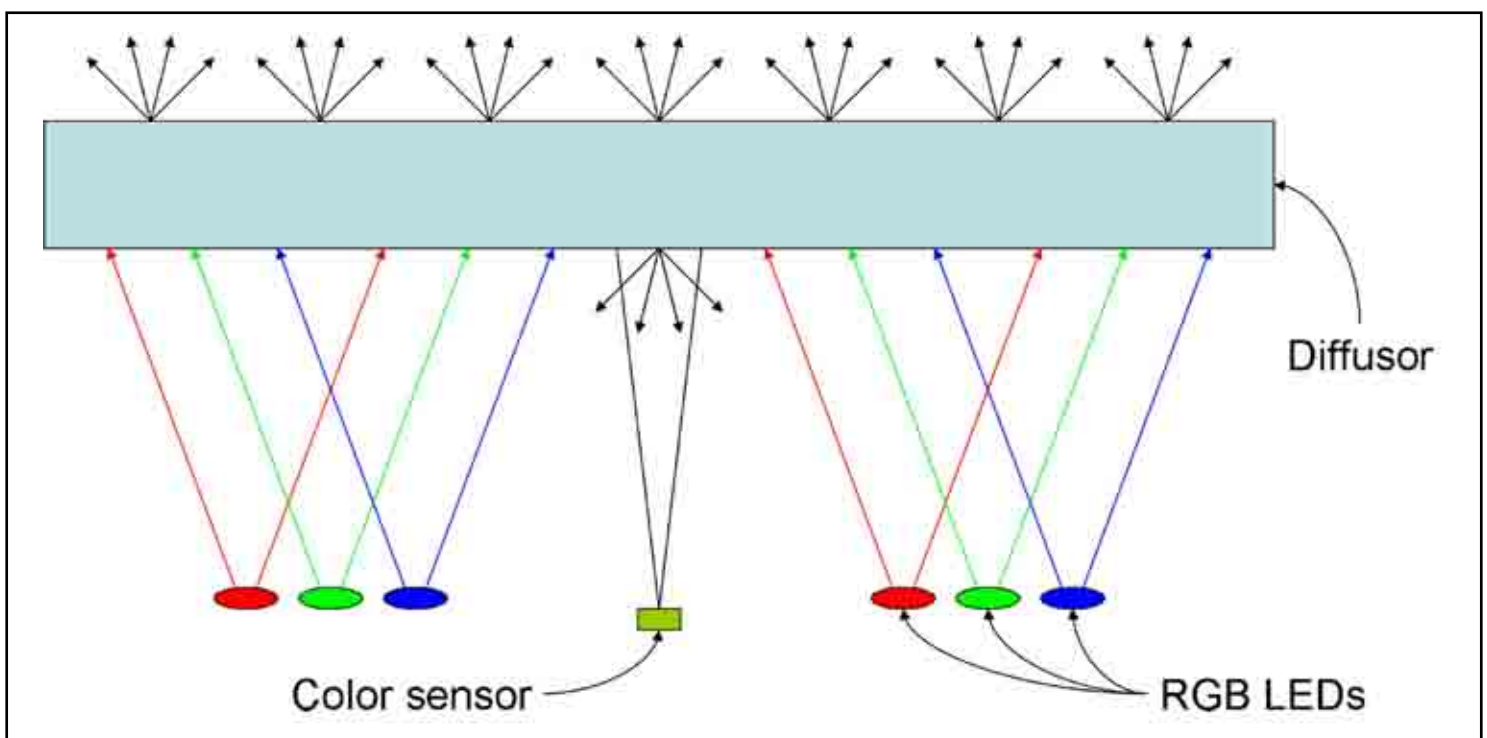

Figure 3: Color sensor placed in a LED system

Depending on the system, different requirements are made. In general, the following basic requirements must be fulfilled:

**Requirement 1:** Color sensor focused on a homogeneous surface.

**Reason:** Stray light or direct light of one LED causes a measuring error.

**Solution:** For a sufficient mixing of LED light, a basic lighting device is chosen where the RGB LEDs and the color sensor are installed behind a diffuser (Figure 3). Other designs are possible, of course - for instance placing the sensor and/or the LEDs sidwise of the diffuser or to lead through the LED light with an optical waveguide on the sensor surface.

**Requirement 2:** Fast electrical small signal amplification.

**Reason:** The generated photo current is in the range of nano-/microampere. In addition, many LED systems are used in applications, where the desired, controlled color must be available in a few milliseconds.

**Solution:** One possibility is the transimpedance amplifier e.g. MT104 of MAZeT GmbH. This current-voltage converter is specially designed for small currents. It furthermore features eight amplification stages to adapt the amplification to the illuminance (see requirement 3) for a high dynamic range.

**Requirement 3:** Adjustment of the digitalized values to the operating temperature range.

**Reason:** The relative light output of long wave (red) LEDs can decrease up to 40% during a temperature rise from 0°C to 50°C. Because of the linear dependency of illumination and photo current, the digitalized values will decrease/increase at the same amount. To avoid overamplifying of the sensor when the LED is cooled, the digitalized values must be fit to the operating temperature range for the LED system.

**Solution:** For low-cost systems or a limited temperature range, it is effectual to adjust the digitalized sensor values to 50% - 70% when all LEDs are set to maximum power at medium ambient temperature. For example 60% at 25°C will provide about 80% at 50°C. For expanded temperature ranges or systems with a high performance concerning the brightness modulation, e.g. the above-named MTI04 offers the possibility to set the required amplification for adjusting the digitalized values to the actual needs.

According to the actual state of technology, LEDs are driven via pulse width modulation (PWM) with a constant current or are controlled by forward current. A disadvantage of current controlled LED drivers is the additional shift of wavelength depending on a change of the forward current. This causes a second variation of the chromaticity coordinate in addition to the variation due to the temperature. E.g. the MTCSiCS in combination with the MTI04 can operate with both types of LED drivers. So, the above-mentioned disadvantage of current controlled LED drivers is compensated without any extra efforts in hardware or software.

This fact provides an opportunity for LED systems with high requirements concerning dynamic behavior: To control the desired color via PWM and the brightness via current control. The advantage is a higher PWM resolution for low brightness colors, where the human eye is more sensitive against color changes.

## Improvement of color stability

To demonstrate the compensation of color drift caused by temperature variation with color sensors, a LED system with the MTCs-C2 Colorimeter Board (4) is realized. This board consists of an MTCsICS true color sensor, an MTI04 transimpedance amplifier and a microcontroller to

send the 10-bit digitalized sensor values via USB to a PC. For the test, a MTCs-C2 is modified by replacing the MTCsICS with a RGB color sensor.

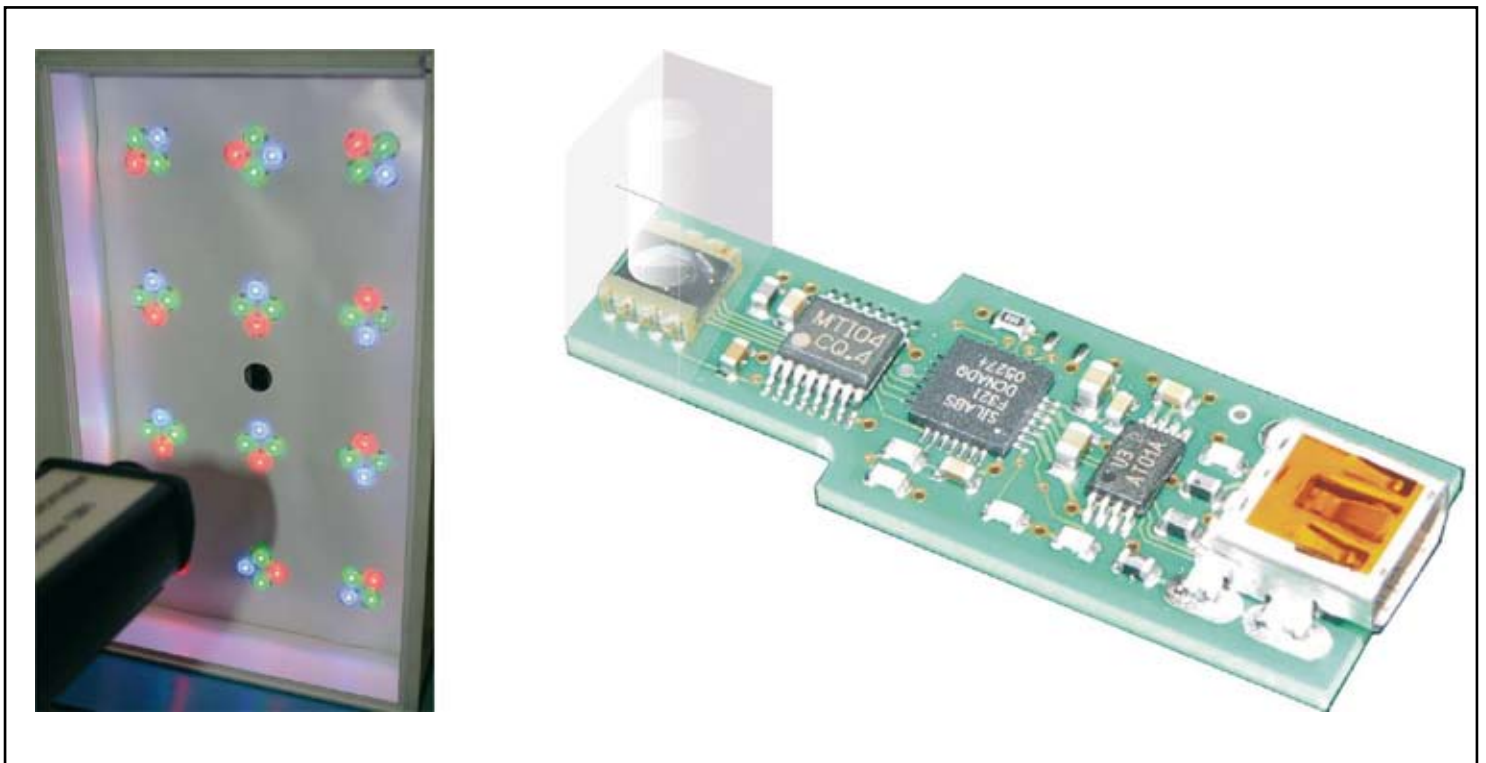





Figure 4: MTCs-C2 Colorimeter Board (right) / example for backlight demonstrator (left) with a measurement position for the true color sensor in the middle of the panel (diffuser for picture removed).

A RGB Power LED (peak wavelengths 465nm - 530nm - 625nm), driven with 8-bit PWM and 250mA, is placed behind a diffuser, which homogenizes the LED light. The MTCS-C2 and a spectrometer - for an accurate measurement of the color chromaticity and brightness - are positioned in front of the diffuser. Both sensors are calibrated at a heat sink temperature of 40°C. During the test, heat sink temperature is



cooled down to 0°C and heated to 70°C in three runs. The first one without any control, the second is controlled by the MTCS-C2 with RGB color sensor and the third run is controlled by the MTCS-C2 with an MTCSiCS true color sensor. As reference color, the duty cycle of PWM for red, green and blue is set to 70% at 25°C. The following tables show the results measured with the spectrometer:

**Run 1:  
without control**

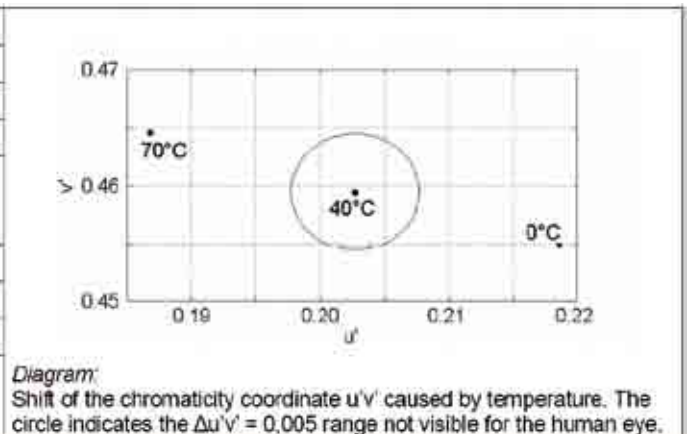
	0°C	40°C	70°C
L*	132,7	125,4	122,6
u'	0,2186	0,2027	0,1868
v'	0,4549	0,4595	0,4646
RGB color			
$\Delta 0^\circ\text{C} - 70^\circ\text{C}$			
$\Delta L^*$	-7,5%		
$\Delta u'v'$	0,0332		



**Run 2:  
control with  
RGB color sensor**

	0°C	40°C	70°C
L*	130,2	127,7	128,9
u'	0,2188	0,2052	0,1961
v'	0,4567	0,4569	0,4578
RGB color			
$\Delta 0^\circ\text{C} - 70^\circ\text{C}$			
$\Delta L^*$	-1,0%		
$\Delta u'v'$	0,0227		

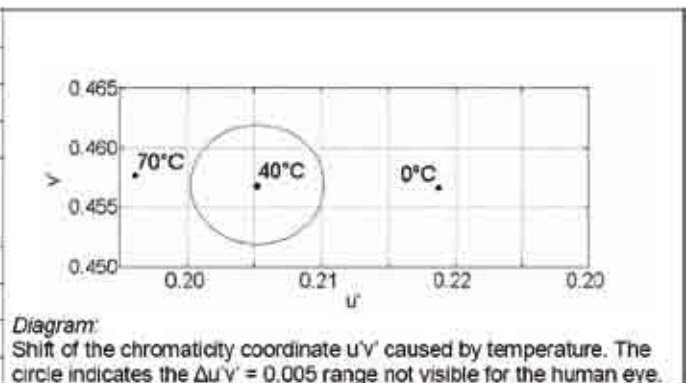

**Run 3:  
control with MTCSiCS  
true color sensor**

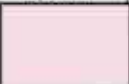
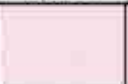
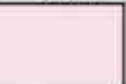
	0°C	40°C	70°C
L*	129,0	128,6	129,4
u'	0,2102	0,2128	0,2129
v'	0,4578	0,4567	0,4568
RGB color			
$\Delta 0^\circ\text{C} - 70^\circ\text{C}$			
$\Delta L^*$	0,3%		
$\Delta u'v'$	0,0028		

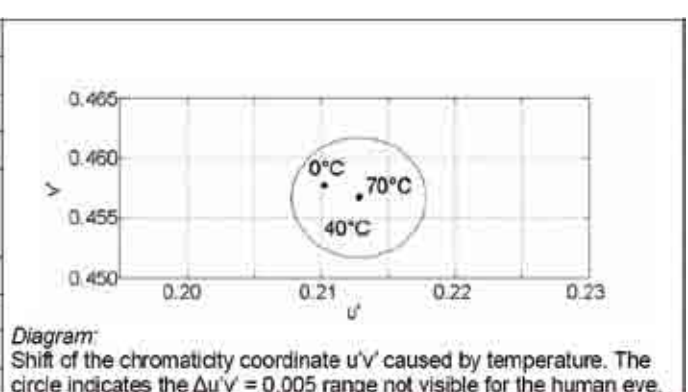

*Notice: The RGB-colors are computed out of the corresponding chromaticity coordinate u'v', while the brightness L\* is scaled to 1. Due to different color gamut of displays or print media, the RGB-colors can appear inaccurate. However, the shift of chromaticity coordinates between uncontrolled, controlled ones with an RGB color sensor and controlled ones with an MTCSiCS true color sensor is obvious.*

## Summary

Due to the shift of the chromaticity coordinate and brightness in dependency to temperature, aging and forward current, a control of multicolor LEDs is necessary in applications where homogenous and constant light must be created. A control by measuring the junction temperature requires the exact knowledge of the LED characteristics.

It was shown that uncontrolled LED systems produce unacceptable color differences over a temperature range of 70K. In systems controlled with RGB color sensors, the differences are reduced, but are still about a factor 4 above  $\Delta u'v' = 0,005$ . Only the use of true color sensors leads to success and provides results not visible to the human eye. ■

**JENCOLOR**  
Sensor Design and Manufacturing Services

**True Color Sensor ICs**

- ▶ Colorimetry with the tristimulus method DIN 5033 (German Institute for Standardization = DIN)
- ▶ Detector with normal tristimulus value - sensitivity
- ▶ On-Chip integrated interference filter
- ▶ small - precise - fast - compact

Color Measurement - like human eye

JENCOLOR c/o MAZET GmbH, Gomschwitzer Straße 32, 07745 JENA Germany. Phone: +49 3641 2809-0, Telefax: +49 3641 2809-12, E-Mail: sales@jencolor.de, Url: <http://www.jencolor.de>

## ADVERTISING

Issue	Editorial Focus	Space Close	Material Close	Publication
Nov 2007	Thermal Management	Nov 9	Nov 16	Nov 30
Jan 2008	Coloured LED systems	Jan 11	Jan 18	Jan 30
Mar 2008	LED lighting systems Preview Light & Building 2008	Mar 7	Mar 14	Mar 28
Mai 2008	Review Light & Building 2008 Preview Lightfair 2008	May 2	May 9	May 16
Jul 2008	LED / Solar systems	Jul 11	Jul 18	Jul 31
Sep 2008	LED and luminary optics	Sep 12	Sep 19	Sep 30
Nov 2008	LED system simulation and testing	Nov 7	Nov 14	Nov 28

Editorial Calendar 2007 / 2008

## LED professional Review (LpR)– Media Kit 2007

Send Email to: [editors@led-professional.com](mailto:editors@led-professional.com)

Ref: LpR Media Kit or call us at: +43 5572 394489

# Trends of Engineering system Evolution: Ideality

> Siegfried Luger, LED professional

## Introduction

Ideality is one of the basic innovation concepts. Ideality is the essence that moves man to improve any technical systems – to make them faster, better and at lower cost. To increase the useful functions and/or to reduce the harmful functions moves the system closer to Ideality. Therefore, Ideality can be described as follows: Ideality = useful functions / (harmful functions + costs)

As the formula states, a system's Ideality can be increased three ways: 1) increasing the useful functions in the numerator, 2) decreasing any harmful functions or costs in the denominator or 3) a combination of one and two.

The real system approximates the ideal system by resolving contradictions, utilization of resources, minimizing parts (trimming) and using new physical chemical and geometrical phenomenon and effects without adding harmful functions.

According to innovation theory, the Ideal System is a system that does not materially exist, while its function is performed. During their evolutions all systems become more ideal and their abilities to meet the needs of people increases while their costs decrease. Achievement of an ideal is practically impossible but is reliable as a guide during problem solving and evaluating solutions. The Ideal System is a theoretical concept and is a powerful tool used not only in systematic innovation but also in other scientific areas. It is an effective approach related to the desire of the developer to get necessary function without complicating the system. Actually, real systems approximate the ideal by increasing their profitable functions and eliminating harmful factors.

## Key questions to analyze a technical system

- Do I need the function offered by a part?
- Can something else in or around the system perform the function?
- Can an existing resource perform the function?
- Can a low cost alternative perform the function?
- Must the part move relative to other parts
- Must the part be of a different material or isolated from its mating parts?
- Must the part be separate from mating parts to facilitate assembly or dis-assembly

## 'Self' Solutions

Solutions that achieve functions 'by themselves' are very important in the sense of a world in which the overall technology evolution driver is increasing ideality. In this sense, the concept of Ideality, and the idea of looking for solutions which incorporate the word 'self' – i.e. the problem solves itself – is a very powerful tool.

## Conclusions

'Self' is a very important word in the context of looking for good solutions to problems; if a system can solve a problem 'by itself', it will be a more ideal solution than one that requires the inclusion of external factors which serve to complicate the system.

There is a difference between traditional and ideality-driven definitions of 'self'. Traditionally, if we add new functions, the system has to become more complex. The ideality-driven definition gets us to think harder about whether we can achieve the additional functionality using resources that already exist in or around the system, and without increased complexity.

## FACT BOX

### No. 3: Local quality

- A:** Change an object's structure from uniform to non-uniform, change an external environment (or external influence) from uniform to non-uniform.
- PWM control instead of DC control
  - Measure gradients e.g. of temperature and/or light
- B:** Make each part of an object function in conditions most suitable for its operation.
- LEDs with changeable optics / lenses
- C:** Make each part of an object fulfill a different and useful function.

# Lower cost, higher flexibility for different LED drive current levels

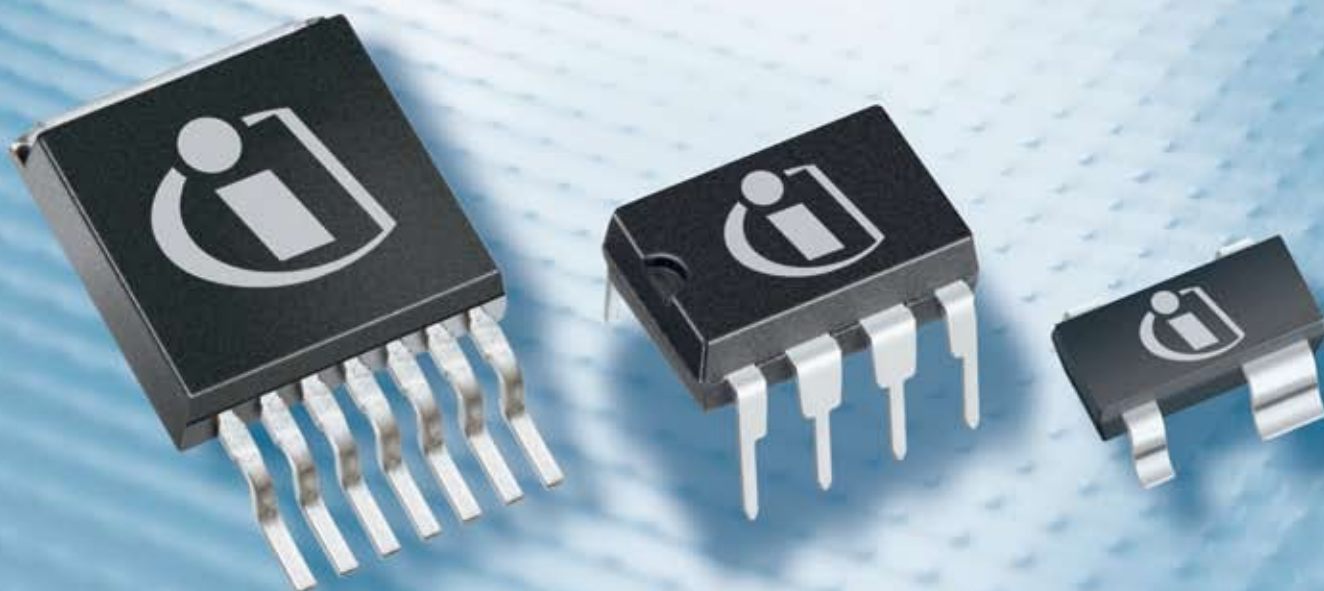

LINEAR CONSTANT CURRENT LED DRIVERS are the most cost-effective method of optimal LED driving. Their flexibility and technical advantages increase efficiency, optimize system costs and help LED applications to become widespread.

INFINEON TECHNOLOGIES OFFERS a comprehensive range of dedicated linear driver ICs beginning with very low-cost constant current sources for currents of up to 65 mA in stand-alone operation, going right up to high-performance driver ICs with integrated diagnostic functions.

FOR HIGHER POWER LEDs Infineon Technologies provides a compact and flexible off-line LED SMPS solution, which was designed to give maximum safety, reliability and improved EMI performance whilst protecting the LEDs during load transients. The compact design is suitable for use worldwide and ensures highly efficient driving of up to 10 series LEDs at up to 350 mA. The circuit also features a highly accurate output current control and a very low standby power rating during no load condition.

Contact us now to learn more about the Infineon LED driver portfolio.

[www.infineon.com/leddriver](http://www.infineon.com/leddriver)



Never stop thinking

# PRECISE, RELIABLE, HIGH BRIGHTNESS LED DRIVER ICs

*For Constant LED Current Regulation*

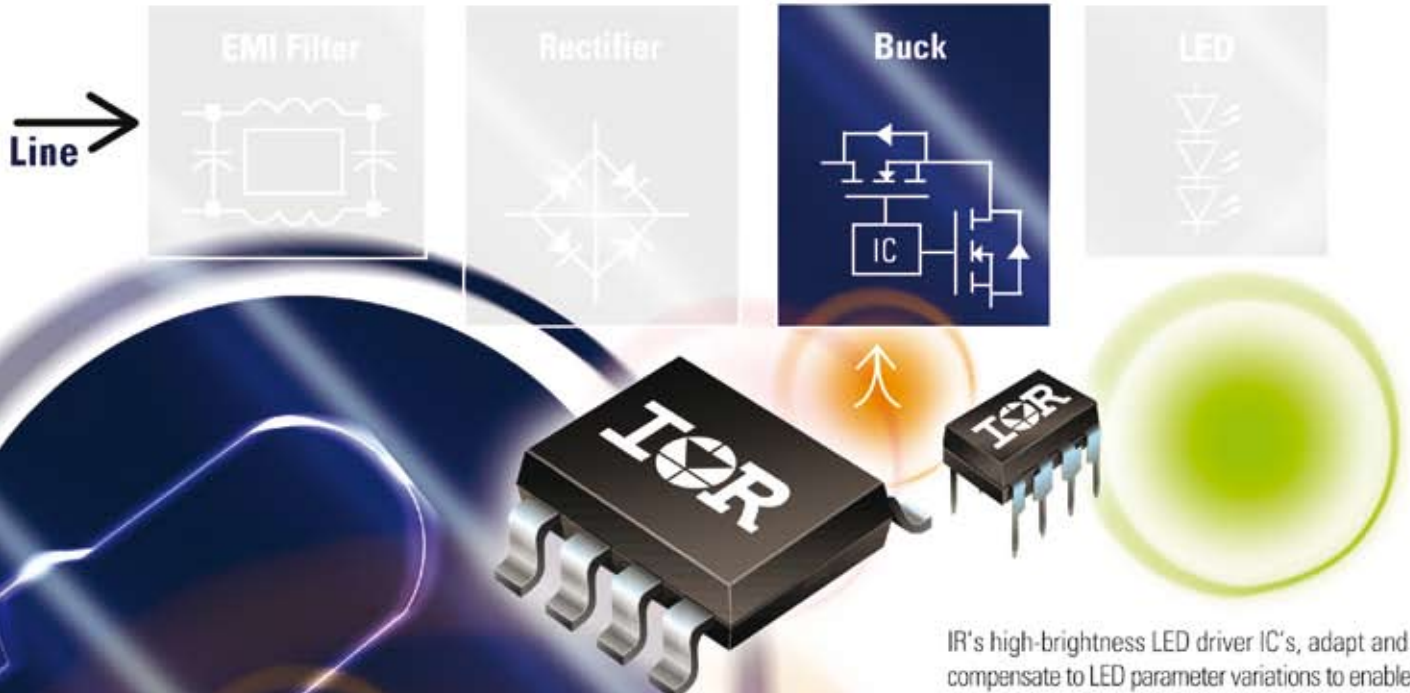

IR's high-brightness LED driver IC's, adapt and compensate to LED parameter variations to enable a highly accurate and inherently stable design.

## FEATURES

- 200V or 600V control IC in compact 8-pin DIP or SO package
- Incorporates continuous mode, time-delayed hysteretic buck regulator
- External high-side bootstrap circuit delivers frequencies up to 500kHz
- Low-side driver provided for synchronous rectifier designs
- Micro-power startup of less than 500µA
- 140ns deadtime for continuous current regulation
- Auto restart, non-latched shutdown and PWM dimmable capability

Part No.	Package	Voltage	Load Current Regulation	Micro-power Start-up	Deadtime	Frequency
IRS2540PbF	DIP8, S08	200V	+/-5%	<500µA	140ns	<500kHz
IRS2541PbF	DIP8, S08	600V	+/-5%	<500µA	140ns	<500kHz

International  
**IR** Rectifier  
THE POWER MANAGEMENT LEADER

For more information call +44 (0)1737 227215  
or +49 (0) 6102 884 311 or visit us at  
[www.irf.com/lighting](http://www.irf.com/lighting)