

**LED**  
professional

[www.led-professional.com](http://www.led-professional.com)

ISSN 1993-890X

# Review

LpR

*The technology of tomorrow for general lighting applications.*

Jan/Feb 2008 | Issue

**05**



**Colored LED Systems  
Visual Perception  
LED Measurement**

free version  
low resolution  
view only



LIGHTING FOREVER



# The light for a new tomorrow

**Better technology, better results.**

## Ultra Bright - High Power LEDs

Leading the way in innovation and specialty, EVERLIGHT continues to develop a broad portfolio of high-power LEDs providing high luminance and high efficiency, while satisfying the demands of today's interior and exterior lighting applications.

As a pioneer in the optoelectronic industry, our everlasting mission is to develop leading edge LEDs that brighten our world whilst being environmentally safe and contributing to a better life for all mankind.

More information about the company's diverse products and solid-state lighting solutions can be found at [www.everlight.com](http://www.everlight.com)



EHP-AX07



EHP-AX08



EHP-5393J



EHP-803

## Color – A new Degree of Freedom



Color is in fashion. Each color has its respective connotation, association and symbolism. It is necessary to understand the interpretation of these individual colors and the sensation created by them before applying it to architecture, and though associations with a particular color can be universal, color symbolism may differ from culture to culture. Speaking of the general class characteristics of the following three groups of colors, many physiologists and psychologists, agree on the following fundamental propositions, that Red is exciting to the mind and emotions, Yellow is inspiring, elevating, and intellectually stimulating, and Blue is cool, soothing, and calming. Colored light can impart identity to a space. Hence we need to understand the space/architecture, its identity, and its inhabitants, before applying colored light.

White LED light sources are expected to have a major impact on the general lighting market. White LED lamps based on sophisticated additive color mixing have distinct advantages compared to white LED lamps based on phosphor-conversion only: higher luminous efficacy and higher luminous efficiency, better color rendering properties usually quantified as a higher CRI (color rendering index), adjustable color temperature, more vivid colors, and possibility to produce variable colored light.

The flexibility of adjustable Color Rendering and Color Temperature is a key feature of LED lighting and opened fairly new applications. While adjustable light output (dimming) is well understood as an effective method to save energy in unoccupied spaces and/or in daylight controlled systems, LED lamp efficacy can be increased up to 30% by strategically lowering the color rendering or by mixing the light of efficient phosphor coated and colored LEDs. The notable point is that in case of modulating CR, the light level and CT can stay constant and therefore the appearance of the light source stays the same.

LEDs with its specific spectral distributions also generated the demand to re-characterize the influence of LED light to human beings and to redefine the existing light measuring methodologies.

Colored LED lighting systems give us a new degree of freedom but they force us to develop intelligent system solutions on different levels as die and phosphor level, module level, optics, closed loop color regulation, driving part and finally, not to forget, the human interface.

With the January/February issue of the LED professional Review (LpR) some important colored LED system topics are covered in depth, hoping that it's useful for your work.

Please send us your feedback about the LpR content. We would like to get your opinion on how to continuously improve our services to you. Furthermore take the opportunity for your own editorial contribution as well.

Yours Sincerely,

Siegfried Luger

Publisher

## Imprint

LED professional Review (LpR)

ISSN 1993-890X

### Publisher

Luger Research

Institute for Innovation & Technology

dep LED professional

Rhombergs Fabrik

A 6850 Dornbirn, Austria / Europe

phone +43 5572 394 489

fax +43 5572 394 698

editors@led-professional.com

www.led-professional.com

### Publishing Editors

Siegfried Luger, EMBE

Arno Grabher-Meyer

Jasmine Leger, Dr.

### Front-page picture

OSRAM: Color Mixing System

### Copyrights – Luger Research

The editors make every reasonable effort to verify the information published, but Luger Research assumes no responsibility for the validity of any manufacturers, non profit organisations or individuals claims or statements. Luger Research does not assume and hereby disclaims any liability to any person for any loss or damage caused by errors or omissions in the material contained herein, regardless of whether such errors result from negligence, accident or any other cause whatsoever. You may not copy, reproduce, republish, download, post, broadcast, transmit, make available to the public, or otherwise use of LED professional Review (LpR) content without the prior written permission from Luger Research – Institute for Innovation & Technology, Austria. ■



### LED professional Review (LpR) – Subscription

#### LpR Digital Magazine – free version

- pdf download
- view only, low resolution
- private use

#### LpR Digital Magazine – full version annual subscription

- pdf download
- pictures and graphs in high resolutions, printable
- 6 issues
- access to all previous issues
- commercial use
- Euro 78.80

#### LpR Printed Magazine – annual subscription

- 6 issues
- Euro 158,40

#### Send E-mail to:

editors@led-professional.com

#### LpR Issue – Mar/Apr 2008

- Light & Building – Special

# Content

<b>Editorial</b>	p 1
<b>Imprint</b>	p 2
<b>Project News</b>	p 4
<b>Product News</b>	p 4
<b>Research News</b>	p 7
<b>IP News</b>	p 7

## ■ Application

### High Tech for Time Square's New Years Eve Ball

by Jason Harris Koonce, e:cue Lighting Control p 9

## ■ Characterization

### Visual Perception Issues of LED Applications

by Ingrid M.L. Vogels, Pieter J.H. Seuntjens and Dragan Sekulovski,  
Philips Research Europe p 12

### Measurement of LEDs

by Yoshi Ohno, Cameron Miller, and Yuqin Zong,  
National Institute of Standards and Technology p 17

## ■ Technology

### High Performance Multi-Color LEDs in Chip-On-Board Technology

by Oliver Kückmann and Jörg Hannig, PerkinElmer Elcos GmbH p 22

### White Light LED Technology with Increased Efficiency and Variable CCT

by Erwin Baumgartner, Lumitech GmbH p 26

### LED Binning: A Process to Watch

by Joe Mazzochette, Lamina p 30

## ■ Methodology

### TRIZ Introduction

by Siegfried Luger, LED professional p 33

## Advertising Index

Everlight	p C2
Power Vector	p 8
Instrument Systems	p 8
DiCon Fiberoptics	p 8
Nimbus Group	p 8
austriamicrosystems	p 11
LED China 2008	p 21
DEX Electronic Exhibition 2008	p 32
LED Taiwan 2008	p C3
Tridonic.Atco	p C4

## Project News

### OSRAM Equipts Cruise Ships with Innovative LED Lighting

MEYER WERFT, one of the world market leaders in the construction of cruise ships, is applying its considerable know-how in terms of innovative trends and cutting-edge developments in shipbuilding to the area of on-board lighting. OSRAM, as the leading supplier of special marine lighting solutions, develops systems that are tailored for each individual ship. These include LED systems and extensive lighting management systems.

These modern and energy-efficient lighting solutions are already enjoyed by passengers on the AIDAdiva. Two further ships are currently under construction at MEYER WERFT: AIDAbella and Celebrity Solstice for Celebrity Cruises.



Special LED solutions provide atmosphere on the AIDAdiva (Photo: MEYER WERFT)

Of all the energy used on board modern cruise ships that is not required for propulsion, the lighting systems account for up to 40 percent. With innovative lighting solutions from OSRAM it is possible to save up to 30 percent of the connected load needed for lighting; as the new lighting systems weigh considerably less than their old counterparts the overall weight can be reduced by as much as eight tons. For a cruise ship designed to take 2,500 passengers and equipped with around 50,000 light sources, this translates into a reduction in CO<sub>2</sub> emissions of up to 3,000 tons per year and annual cost savings of up to US\$ 300,000.

Bernard Meyer, Managing Director of MEYER WERFT added: "The lighting solutions from OSRAM and the associated reduction in emissions and energy consumption bring us a whole lot closer to our objective of building "green ships". ■

## Product News

### TI DC/DC Converter with an Integrated 40-V, 1.2-A Current Switch

Texas Instruments Incorporated (TI) recently introduced a high-brightness LED driver with an integrated 40-V, 1.2-A switch that can drive up to three 1-W LEDs in series. The new TPS61165 device's high-performance features and input voltage range of 3-V to 18-V allow designers to efficiently manage multiple high-power LEDs used in single-cell, battery-powered applications or point-of-load designs with a 9-V or 12-V bus.

The TPS61165 allows LED brightness to be controlled by a digital single-wire interface or pulse width modulating (PWM) signal. The digital interface can program an internal register to set the LED current to one of the 32 logarithmic steps. The converter also comes with built-in protection features, such as open LED protection, soft-start, over-current limit and over-temperature protection.

In addition to driving illumination LEDs, the TPS61165 can drive backlight LEDs for media form factor displays up to 9 inches in diameter, such as those used in ultra-mobile PCs and LCD photo frames, industrial laser diodes or medical and industrial lighting.

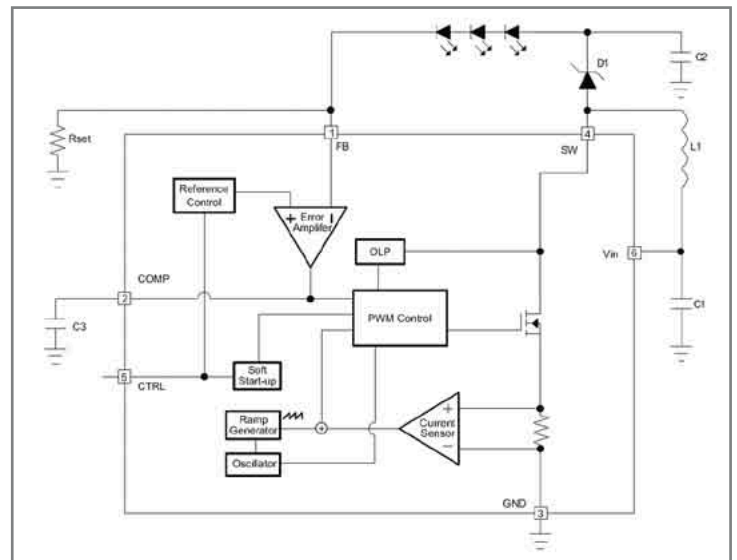

Functional Block Diagram

#### Key Features of TPS61165:

- Wide input voltage range up to 18-V
- Integrated 40-V 1.2-A high-efficiency switching FET
- 1.2-MHz switching frequency
- 90-percent power efficiency
- 32-step single-wire digital dimming or PWM dimming

TI also introduced its new TPS61160 and TPS61161 converters that support input voltages from 3-V to 18-V. Both devices integrate a 0.6-A current switch and target portable and battery powered applications with small displays, such as small 3-inch or 4-inch LCD display backlighting in portable game players, GPS systems and smart phones. The TPS61160 drives up to six LEDs with 26-V open LED protection, while the TPS61161 drives up to 10 LEDs with 38-V open LED protection. As with the TPS61165, the brightness of the LED can be controlled by a single-wire digital interface or PWM signal, and analog dimming eliminates noise. ■

## High Power LED with Diamond Insulation Layer

Everlight's brand-new 5 Watt EHP-B03 Series emitters are the best products available on the market for applications which require both small size and brightness performance using a diamond insulation layer.

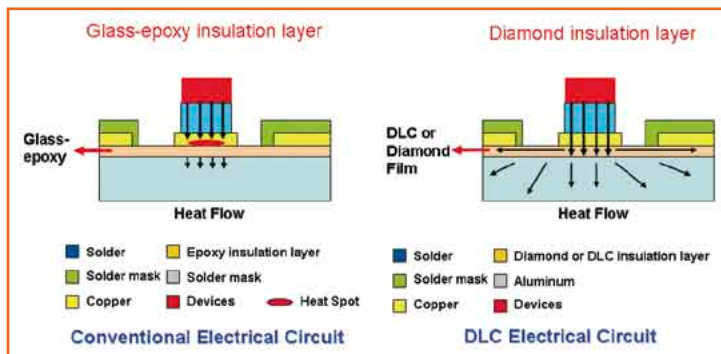

Everlight's MCPCB Mechanism Structure

Made of Everlight's industry-leading packaging technology, the EHP-B03 Series are designed, binned and tested for standard operation @ 700mA and have the capability of being driven @ 1000 mA. The EHP-B03 Series come with a special design – MCPCB (DLC based), usually called Star, which allows more effective heat dissipation and lowers the thermal resistance between junction and Star to a typical value of 11K/W

Everlight's EHP-B03 Series deliver light output performance of 250 lm @ 700 mA and offer optical efficiency of 50 lm/W. For applications like backlighting (illuminated advertising general lighting), reading lamps (aircraft bus), commercial and residential architectural lighting where high brightness and reliability are required while still demonstrating improved efficiency, EHP-B03 Series can provide the most cost effective and user friendly solutions that take every aspect of LED issue into consideration. ■

## High-Power, High-Voltage, Programmable LED Driver

Maxim Integrated Products (Pink Sheets: MXIM) introduces the MAX16816, a high-voltage, programmable, high-brightness (HB) LED driver for automotive and general lighting applications. Far more versatile than competitive devices, the MAX16816 provides many user-programmable features through on-chip nonvolatile EEPROM registers. Using a microcontroller and a single-wire interface, the programming is done either at the factory or by the designer in the field.

The MAX16816 integrates all the building blocks necessary to implement fixed-frequency HBLED drivers with wide-range dimming control. It is configurable to operate as a step-down (buck), step-up (boost) or step-up/down (buck-boost) current regulator.

The Current-mode control with adjustable leading-edge blanking simplifies control-loop design. Adjustable slope compensation stabilizes the current loop when operating at duty cycles above 50%. The MAX16816 operates over a wide input voltage range and is capable of withstanding automotive load-dump events. Multiple MAX16816 devices can be synchronized to each other or to an external clock. The MAX16816 includes a floating dimming driver for brightness control with an external n-channel MOSFET in series with the LED string.

HB LEDs using the MAX16816 can achieve efficiencies of over 90% in automotive applications. The MAX16816 also includes a 1.4A source and 2A sink gate driver for driving switching MOSFETs in high-power LED driver applications, such as front light assemblies. Dimming control allows for wide PWM dimming range at frequencies up to 5kHz. Higher dimming ratios (up to 1000:1) are achievable at lower dimming frequencies.

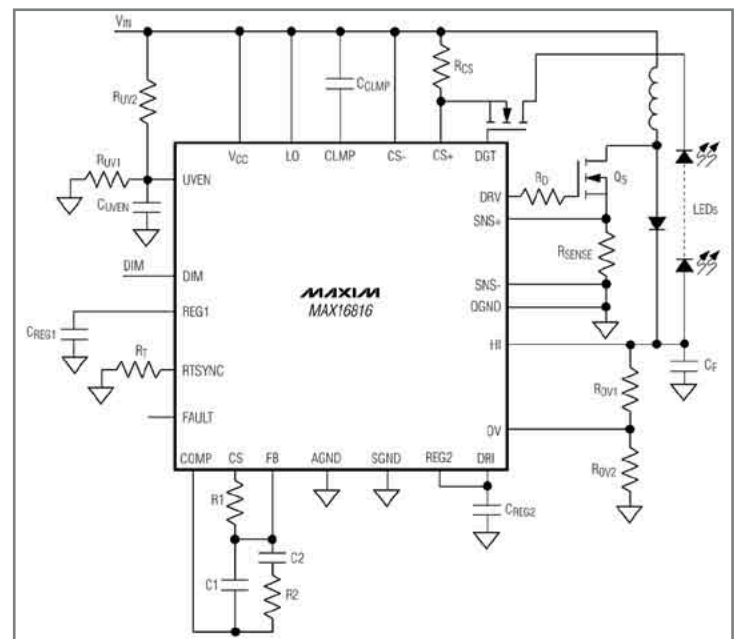

Typical Buck-Boost Application Circuit with MAX16816

The MAX16816 provides user-programmable features through on-chip nonvolatile EEPROM registers. Adjustable features include a programmable soft-start, LED current (binning), external MOSFET gate driver supply voltage, slope compensation, leading-edge blanking time, and disabling/enabling of the RT oscillator.

**Main Features:**

- EEPROM-Programmable LED Current Binning
- Wide Input Range: 5.9V to 76V with Cold Start Operation to 5.4V
- Integrated Floating Differential LED Current-Sense Amplifier
- Floating Dimming Driver Capable of Driving an n-Channel MOSFET
- 5% or Better LED Current Accuracy
- Multiple Topologies: Buck, Boost, Buck-Boost,SEPIC
- Resistor-Programmable Switching Frequency(125kHz to 500kHz) and Synchronization Capability
- 200Hz On-Board Ramp Allows Analog-Controlled PWM Dimming and External PWM Dimming
- Output Overvoltage, Overcurrent, and LED Short Protection
- Enable/Shutdown Input with Shutdown Current Below 45µA

The device is ideal for high-power flood lighting, down lighting, and projection systems that require high-current LED drive capabilities. and is available in a 32-pin TQFN package with exposed pad and operates over the -40°C to +125°C automotive temperature range. ■

## KHATOD Presents Heatsink for AR111 LED Solutions

The Lighting Industry is in great flux creating a wide variety of lighting applications for power LEDs to meet the demand of the market. The diverse LED applications have produced new projects for manufacturers. Many of these applications require placement of LEDs in narrow and or recessed spaces. This evolution is not without difficulties, such as the need to disperse the excess heat produced by LEDs.

Khatod, the leading producer in the optoelectronic industry evolution, has promptly responded to the this requirement of the market by creating a new series of HEATSINKS. They allow an excellent dispersion of the heat produced by the Power LEDs in various applications.

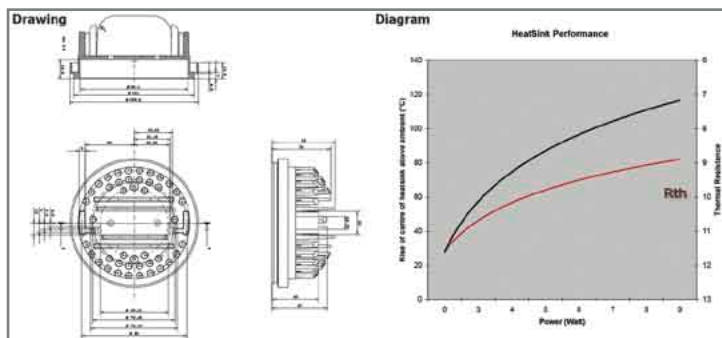

KHS111 outline and performance diagram

Khatod Heatsinks, are available with all of our families of secondary optics for the major LED manufacturers, which can be viewed on our website.

The HEATSINKS can be used both in single LED solutions or in applications complying with MR11 and MR16 Standards. KHS67 Heatsink can be used in single LED solutions KHS35 (32mm diameter), KHS500 (45mm diameter) and KHS502 (45mm diameter) Heatsinks can be used in all the applications where solid light is required. The latest model created by Khatod is KHS111. This heatsink has been created for all the applications complying with AR111 Standard. Through an innovative manufacturing system, the LED-lens-heatsink assembly is a perfect integrated unit for the market. ■

## Edison Opto Introduces New 10W PAR30 Module

Edison Opto 10W/PAR30 Module utilizes 6 Edixeon® LEDs, capable of producing an illumination of 3,700 lux at one meter. This module integrates advanced LED technology with proprietary optics and high-tech heatsink into an effective design.



Edison Opto 10W PAR30

The condensed light emitting area through the advanced optics design allows a cleaner and better defined light output. In addition to all the benefits you could expect from LEDs, you will get an attractive and easy-to-use solution with the 10W/PAR30 Module.

**Absolute Maximum Ratings:**

Parameter	Rating	Units
LED Junction Temperature	125	°C
Operating Temperature	-30 ~ +40	°C
Storage Temperature	-40 ~ +60	°C
DC Input Voltage	24	V
Constant Current	500	mA
Equilibrium	60	°C
Weight	170±5	g

The compact and integral design of the 10W/PAR30 Module make it ideal for a wide variety of lighting applications, including retail store spot light, ceiling downlight, and many other accent lightings. ■



## Research News

# Characterization of Color Rendering of LED Light Sources

The CIE method applied since 1974 for defining the CRI (color rendering index) allows the quantification of the "quality" of the light generated by artificial light sources. This index ranging from 0 to 100 defines the capacity of a light source to reproduce the various colors of objects, compared to a reference source, but does not apply correctly to LEDs. So, new studies are recommended to determine a new color index or indices which take white light produced by LEDs into account.

This task falls in the scope of the metrology of appearance. A new research project with the goal to work out a new method which would permit to quantify the color rendering under different LED lighting, thanks to physical and visual measurements is established at LNE-INM/Cnam. Therefore a lot of different aspects will be considered.

The difficulty to measure what we see is to consider each elements intervening in the perception of an object: Lighting (of new sources like light emitting diodes), interactions of light with the material (with pearlescent or interferential facing), the reception of the light on the eye and its interpretation by the brain.

Determination of appearance requires the implementation of instruments and methods that will permit to measure the physical dimensions associated with sources (spectral power distribution) as well as with material characteristics (properties of reflection and transmission). These physical dimensions could be correlated to the human response obtained by visual measurements estimated for a group of persons in the form of a scientific modelling.

Spectral measurements will be made on the emission of samples thoroughly selected, illuminated by LED sources and by CIE reference sources to determine color differences. These color differences will be, then, compared with those obtained by visual measurements to look for a new color rendering index.

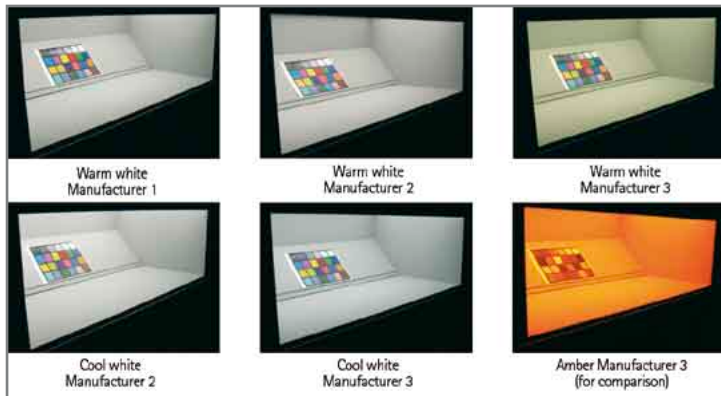

Testboxes for the visual measurement with different LED light sources

Furthermore, metrological studies will be made on the characteristics of sources used and particularly on their luminance and their spectral power distribution stability, which seems not to be an unimportant parameter during the visual measurements.

For information on the progress of the project contact Nicolas Pousset (Optical Radiation Team, LNE-INM/Cnam, 61 Rue du Landy, 93210 La Plaine - Saint-Denis, France, e-mail : nicolas.pousset@cnam.fr) ■

## IP News

# Monolithic multi-color, multi-quantum well LED

Blue Photonics Inc. (Walnut, CA, US) filed at 08/25/2005 a patent application which was granted as US7323721B2 at 01/29/2008 and claims a solution to provide a light source that emits a mixture of different colored light out of one single die.

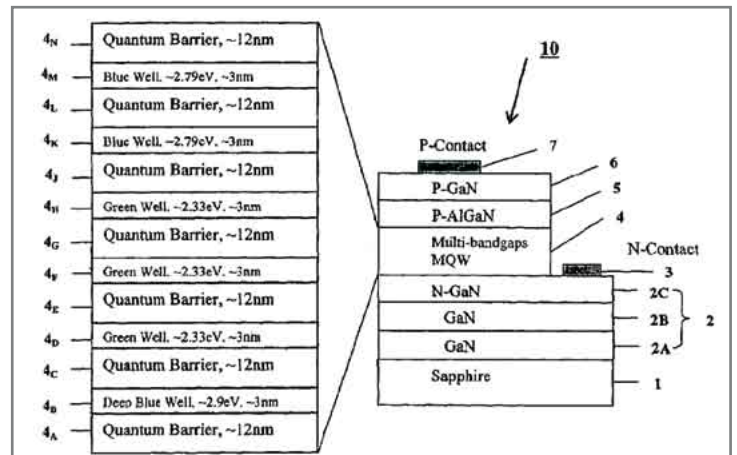

Figure according to the Primary Claim

### Abstract:

A monolithic, multi-color semiconductor light emitting diode (LED) is formed with a multi-bandgap, multi-quantum well (MQW) active light emitting region which emits light at spaced-apart wavelength bands or regions ranging from UV to red. The MQW active light emitting region comprises a MQW layer stack including n quantum barriers which space apart n-1 quantum wells. Embodiments include those wherein the MQW layer stack includes quantum wells of at least two different bandgaps for emitting light of two different wavelengths, e.g., in the blue or green regions and in at least one other region, and the intensities of the emissions are adjusted to provide a preselected color of combined light emission, preferably white light. ■



## POWER VECTOR IS: ENGINEERED LED POWER

Our Team of engineers, designers, and software specialists has a history of delivering innovative and effective power solutions. Power Vector's 3-IN-1 **IRIS LED Driver Dimmer™** combines Power Isolation, DMX512A Interface, and up to 8 Configurable Channels for driving and dimming ANY high brightness LEDs.

- 86 Watts
- Ideal for any High Brightness LEDs from 350mA up to 1.5A
- Class 2 Outputs
- USITT DMX512A Compatible
- Power Vector's Unique Dimming Method, used in all our products

Coming soon, Power Vector's **TRINITY LED Driver Dimmer™**.

## 3 IN 1 LED DRIVER DIMMERS

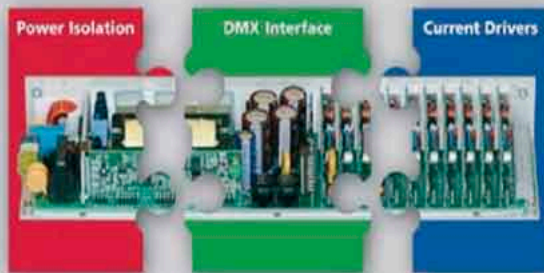

**PUZZLE SOLVED**

Have a look at our website [www.powervector.com](http://www.powervector.com).  
For more information call 1-888-LED-3IN1(533-3461)  
or email to [info@powervector.com](mailto:info@powervector.com).

CREATING LIGHT WITH **SOLID-STATE TECHNOLOGY**

# LED FiberLamps™

## FULL COLOR ILLUMINATORS

- Architectural Cove and Wall-wash • Neon Replacement
- Entertainment • Outdoor Illumination

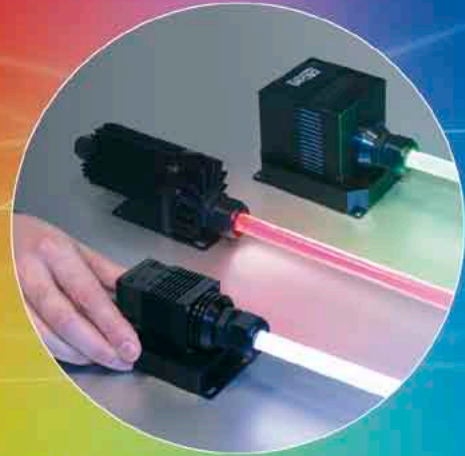

**Smarter** — dynamic, programmable color animation  
**Smaller** — compact light sources  
**Brighter** — brighter than illuminators twice their size

**DiCon**  
FIBEROPTICS, INC

[sales@diconlighting.com](mailto:sales@diconlighting.com)  
(510) 620-5250  
[www.diconlighting.com](http://www.diconlighting.com)

## LED Test and Measurement



Measure all optical and electrical parameters of single LEDs, high-power LEDs and LED modules in conformity to international standards accurately and within seconds. With equipment from INSTRUMENT SYSTEMS – the world leader in LED metrology.

- Luminous intensity (candela)
- Luminous flux (lumen)
- Dominant wavelength (nm)
- Color coordinates (x, y, z)
- Spatial radiation pattern
- Thermal behavior

**INSTRUMENT SYSTEMS**  
LIGHT MEASUREMENT

phone +49 89 45 49 43-0  
[info@instrumentsystems.de](mailto:info@instrumentsystems.de)  
[www.instrumentsystems.de](http://www.instrumentsystems.de)

**WE BRING QUALITY TO LIGHT**

Für unsere Design- und Entwicklungsabteilung suchen wir ab sofort  
**Elektroniker / Elektronik-Ingenieure (m/w)**

für die LED-Leuchtenentwicklung

In engem Dialog mit unseren Produkt-Designern entwickeln und konstruieren Sie hochwertige Wohn- und Arbeitsplatzleuchten (vorrangig LED-Leuchten) und betreuen mit Ihrem Know-how auch Projekte und Planungen für den Objektbereich. Sie verfügen über eine fundierte elektrotechnische Ausbildung sowie mehrjährige Berufspraxis. Idealerweise haben Sie Kenntnisse in Lichttechnik, Gebäudeelektrik und den gängigen Programmen zum Platinenlayout, sowie einem CAD-Programm (Solid Works).

Ihre Aufgabe umfasst dabei:

- Auswahl und Spezifikation von LED-Technologien
- Elektronische Konzeption von Leuchten, Erstellung von Funktionsaufbauten und Prototypen
- Technische Dokumentation von Leuchten, Erstellung von Schaltbildern und Stücklisten als Grundlage für die hausinterne Produktion
- Betreuung von elektrischen und elektronischen Prüfverfahren
- Anwendungsberatung

Wenn Sie Freude haben, sich in einem jungen Team von 100 hoch motivierten Mitarbeitern zu engagieren, freuen wir uns auf Ihre aussagefähige Bewerbung mit Gehaltsvorstellung und frühest möglichem Eintrittstermin.

**Nimbus Group**  
Personalabteilung  
Sieglestrasse 41  
D 70469 Stuttgart  
[info@nimbus-group.com](mailto:info@nimbus-group.com)  
[www.nimbus-group.com](http://www.nimbus-group.com)

**nimbus**<sup>+</sup>

## Application

# High-Tech for Time Square's New Years Eve Ball

> Jason Harris Koonce, e:cue Lighting Control

### Introduction

In America as in many places around the world, New Years Eve celebrations are a matter of tradition. For the 2008 spectacle was the 100th anniversary of what American media sometimes refers to as the 'big ball drop', this time-honored tradition received some spectacular enhancements. The co-organizers of the event (Times Square Alliance and Countdown Entertainment) unveiled a new high-tech version of what has become a well-known affair. In practical terms the ball received as its birthday gift a wonderful makeover. Namely a crystalline bedazzled, LED adorned version of the New Years Eve Ball was unveiled for the most recent New Year's celebration this past January.



Figure 1: The glamorous high tech New Year Eve Ball

Historically time balls were checks for the marine chronometers of sailors, enabling them to determine their longitude when at sea. The stations where the time balls were located set their clocks according to the position of the sun and stars.

The first 'ball drop' in America occurred on December 31st 1907 from Times Square. Built with iron and wood it was adorned with 100 25-watt light bulbs. At 5 feet (1.52 meters) in diameter and 700 pounds (318 kg) the ball took New Year's Day to a new level and got it off to quite a start for all of those in attendance.

In 1920 and 1955 the ball was renewed. Since then the aluminum ball underwent generally cosmetic changes. For Times Square 2000 the ball was completely redesigned by Waterford Crystal, featuring crystals styled as part of the "Let There Be Light" theme with a new design. The current ball (Figure 1) which dropped on New Year's 2008 was the fifth edition of the ball since 1907 one hundred years ago.

### Concept

The lighting design from Focus Lighting was quite ambitious from the start – "to create a shining gem in the sky. Focus aimed to fully utilize the new techniques, and control to create a truly singular event to captivate an audience of over 1 billion people worldwide.



Figure 2: The Waterford Crystal triangles.

A key ingredient to creating a truly momentous spectacle centered on embracing the brilliant facets of the redesigned crystals (Figure 2). As mentioned, the theme for the magnificent Waterford Crystal triangles is "Let There Be Light". Fittingly, a new aspect of each crystal is cutting on both sides (double cutting) which greatly increase the light refraction within each triangle. Featuring a sunburst design on each crystal, this design resulted in an explosion of vivid color and light – a truly innovative and remarkable effect.

Focus analyzed the various perspectives of the ball dependent on location. Taking into account that perspectives would range from 10 feet (3 meters) to 500 feet away for a reveler on the ground, unique characteristics were developed. Each view of the ball would be different.

Numbering 672, each crystal is individually illuminated, backlit by 12 LED's – three each of red, green, blue and white. Installing solid state lighting technology, the project realized a dramatic increase in its efficiency, brightness and color capability. The total number of LED's is 9,576 replacing the 600 light bulbs on the previous edition, as well a palette of more than 16 million vibrant colors and literally billions of effects patterns are possible.

## Construction, control and operation

A key concern during in the construction was how to maximize the facets of the Waterford Crystal. This was partly addressed with the increase in light refraction and using LED fixtures in place of conventional lighting. The light should radiate from the ball; thus there is also a second layer of LED's encompassing the ball which enhances the geodesic structure of the ball.

The 672 crystal triangles are divided into groups of four fixtures to make up 168 'MAMA' triangles (Figure 3). Each module is constructed from an LED circuit board, a mirrored baffle (to separate the triangles and multiply the individual points of light), and the four crystals. Each side of the main triangle has an additional white 3 LED fixture that interlocks with other modules to form a 'skeleton' for the ball.

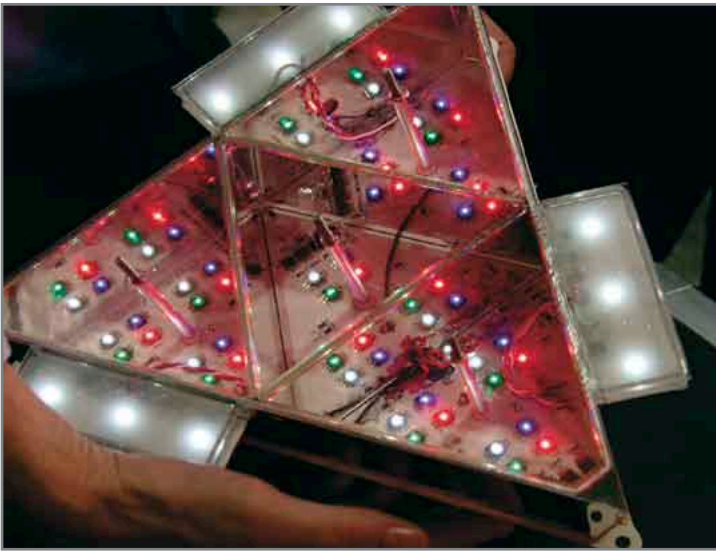

Figure 3: The four triangle LED modules with white LED modules of one "MAMA" triangle

Several design aspects were quite innovative and also required special focus. Among the basic lighting control challenges was that typical matrix design for lighting is always a 2D matrix layout; this needed to be mapped to a 3D surface. This issue is experienced by map makers because it is difficult to project a 3D sphere to a flat surface. High on the spec. list was video-mapping in real-time, a user interface with easy selection of matrix sections, as well as time code synchronizing capability.

The draft sketches delivered included the 'MAMA' triangle set up, and the LED module and DMX addressing. The aim was to first create a 3D simulation of a truncated icosahedron to get a handle on its behavior and organization. Of course the matrix which would be written for the software would have to have an accurate location map in order to properly project video and images.

The first sketch simulation was created using 3D software. The simulation showed the Figure from 3 perspectives simultaneously: views from above, below and from the side. By understanding the regions of the Figure as well as its motion, it could now be charted. In order to render the icosahedron accurately on a matrix, it was further necessary to

create a 3D center-point table. Each of the 720 center-points represents charting points on the sphere where the matrix would be 'hinged'. This table would then have to correspond with the DMX address mapping (Figure 4). An important step because a video is always 2D; the task was akin to wrapping a piece of paper around a ball and charting it that way.

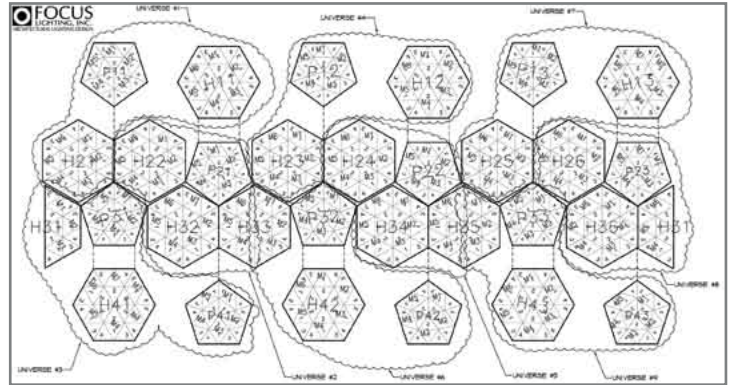

Figure 4: 3D to 2D transformation and grouping for correct DMX address mapping.

Once the center-point table and DMX addressing was derived using the information gathered from the 3D simulation, the show needed to be integrated into the programmer software. Exactly how the mapped addresses would be displayed in the show could be seen by running the software, which can run the matrix in an output simulation.

The Programmer Application Suite lighting control software was the primary tool for programming and show set-up. The software development team devised a custom show file specifically for the ball which allowed designers to interact intuitively with the ball and utilize real-time 3D visualization. Video and static images were able to be mapped to the ball simultaneously with literally billions of effects combinations, because each element of the ball can be independently controlled. One of the more advantageous features of the software for this project was the ability to play up to 24 lighting cues at a time (Figure 5).

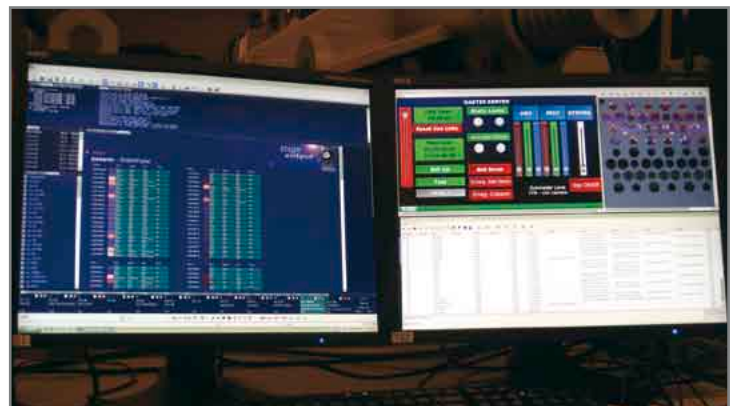

Figure 5: Action board showing user interface and cue list.

Of course, for a project of such prestige and visibility, backup systems must be in place. The control system hardware consists of 2 CS-1 servers as well as 7 butler playback units. This was structured as a 3

# a leap ahead in LED backlight control

## A revolution in LED backligthing

- ▶ Local dimming support for best contrast ratios
- ▶ Highest accuracy for exact backlight colors
- ▶ Simple synchronization of backlight with TV picture
- ▶ Integrated safety features

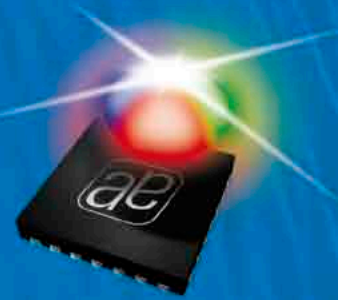

**AS3693** Lighting Management IC

**ae** austriamicrosystems

a leap ahead in analog

[www.austriamicrosystems.com/lighting](http://www.austriamicrosystems.com/lighting)

tiered backup, with 1 server running the show via time code synch with television cameras as well as the Times Square coordinated festivities. Behind the scenes the second server (called a Havarie server) was setup to take over the show at the slightest hint of something being amiss. The backup system (which also simultaneously ran the 10 DMX universes) was constructed with the aforementioned server backup. As well, the capability for the show to be run in stand-alone mode over the butler devices provided an extra blanket of security.

"Times Square has always been an arena where the latest and greatest cutting-edge technology is unveiled and showcased," said Tim Tompkins, President of the Times Square Alliance "and the New Years Eve Ball, like Times Square, is an exciting blend of technology and tradition." ■

#### Project Partners:

Countdown Entertainment  
Times Square Alliance  
Philips Lighting Company  
Waterford Crystal  
Focus Lighting  
e:cue Lighting Control  
Dickmann Manufacturing  
Hudson Scenic Studio  
Landmark Signs  
Lapp Group  
L.E.D. Effects

provided the LED lamp and fixture technology  
provided the crystal for the New Years Eve Ball  
provided the lighting design  
provided the lighting control system  
provided pyramid mirrors  
structural engineering design and development  
assembles and operates the Ball  
provided power and control cabling  
integrated LED technology



Figure 6: New Years Eve celebrations on Times Square

# Characterization

## Visual Perception Issues of LED Applications

> Ingrid M.L. Vogels, Pieter J.H. Seuntjens and Dragan Sekulovski, Philips Research Europe

### Introduction

In the last decade LED technology has shown major improvements. This has led to the replacement of conventional light sources in existing applications and to the introduction of new application areas. LEDs offer tremendous advantages above conventional light sources, such as long lifetime, high durability, low power consumption, no ultraviolet radiation, fast response time, small and flexible designs and highly saturated colors. However, major drawbacks of LEDs are their low performance on color consistency, color stability and color rendering. In order to optimally utilize the advantages of LEDs and to diminish their disadvantages, knowledge about human visual perception is essential. In this paper a number of perception studies are presented that address important perception issues for three applications that use colored LEDs to generate static or dynamic light effects with. The applications are: (1) static light that is perceptually uniform, (2) dynamic light that is perceptually smooth, and, (3) dynamic light with visually appealing color transitions.

### Spatially uniform light

One of the advantages of LEDs above conventional light sources is that they can generate a large variety of saturated and unsaturated colors, especially when three or more colored LEDs are combined into one unit. However, LEDs suffer from serious problems in color reproduction due to the intrinsic color variation between LEDs of the same intended color and the luminance decrease over time. Hence, the perceived colors of two supposedly identical LED spots might be different, and, the color of a supposedly uniform light pattern on a wall might be perceived as non-uniform. In order to create visually appealing light effects with LEDs, knowledge on the visibility of spatial color differences is essential. Many applications and industry standards use the study of MacAdam [1] as a guideline for tolerable color variations. MacAdam showed that the just noticeable difference (JND) between the colors of two light spots placed side by side can be presented as an ellipse in the chromaticity diagram centered on the chromaticity of the reference light (see Figure 1). All colors within an ellipse are perceived as equal. The ellipses show large variations in size and orientation in the CIE 1931  $x,y$  chromaticity diagram but are more uniform in the CIE 1976  $u',v'$  chromaticity diagram. Although the MacAdam ellipses are widely used, it is not known whether the results can be extrapolated to conditions that are different than used by MacAdam. For instance, the effect of

the size of the light spot, the luminance of the light spot, the shape of the color deviation and the ambient illumination has not been investigated.

Beside the sensitivity to color differences between two uniform light fields, researchers have also investigated the sensitivity to color gratings for various frequencies [2, 3]. When the amplitude of the spatial color pattern is smaller than a threshold value, the pattern appears to be uniform (see Figure 2). Although the sensitivity to luminance grating is extensively studied, little is known about the sensitivity to chromatic gratings that vary in hue or saturation.

In order to obtain more insight into the sensitivity to spatial color variations and to develop guidelines for the color variations between LEDs that are allowed, two perception experiments were performed. The first experiment investigated the visibility of a deviation of one LED in an array of eight LEDs. In the second experiment the visibility of color and luminance gratings at various spatial frequencies was studied.

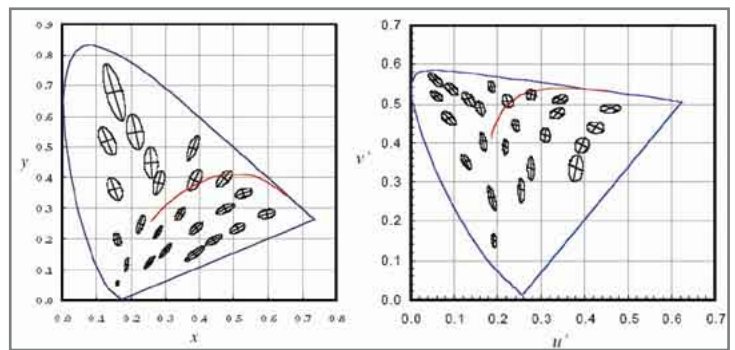

Figure 1: MacAdam ellipses in the CIE 1931 ( $x,y$ ) chromaticity diagram (left) and the CIE 1976 ( $u',v'$ ) chromaticity diagram (right). The plotted ellipses are ten times the actual size.

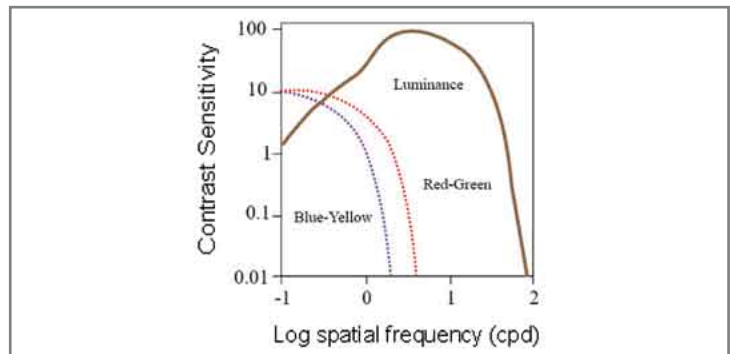

Figure 2: Typical spatial contrast sensitivity functions for luminance contrast (black-white) and chromatic contrast (red-green and blue-yellow) [4].

In the first experiment, eight RGB LED units were mounted on a metal strip of 68 cm that was placed at a distance of 10 cm from a white wall with the LEDs facing the wall. The primaries of the LED units were characterized and simulated to correspond to the (less saturated) EBU primaries. Hence, when all LED units were driven with the same (simulated) RGB values, the chromaticity of the light projected on the wall was constant. In order to create a color deviation on the wall, a color deviation was simulated in the primaries of one of the LED units. The simulated chromaticity of one primary (red, green or blue) or two

primaries (red-green, red-blue or green-blue) was changed in hue or saturation or the maximum luminance of the primary was changed. This resulted in a non-uniform light pattern on the wall with a gaussian-shaped color or luminance profile. Participants were asked to find the maximum color deviation at which the light pattern appeared to be uniform. For each condition, only the colors that were expected to be most critical were displayed. This resulted in saturated red, green, blue, yellow, magenta and cyan for the primaries red, green, blue, red-green, red-blue and green-blue, respectively. In addition, white (D65) was shown for all primary deviations.

The maximum color deviation of the LED primaries at which the light pattern appeared to be uniform was on average  $0.04 \Delta u'v'$ . However, this value strongly depends on the layout of the LED system, such as the distance between LEDs, the distance to the wall and the angular distribution of the LEDs. In order to make the results less dependent on the specific design parameters of the set-up, the results were expressed in actual color or luminance deviations on the wall (see Figure 3). The experiment showed that people are more sensitive to color deviations in a white color compared to saturated colors. In addition, deviations in the hue of the LED primaries are more visible than deviations in the saturation of the primaries. Visibility thresholds for white were on average  $0.004 \Delta u'v'$  for deviations in the hue of the primaries and  $0.007 \Delta u'v'$  for deviations in the saturation of the primaries. Visibility thresholds for saturated colors were on average two times larger. Deviations in the luminance of the primaries were hardly visible for saturated colors. In the case of a white color, a luminance deviation in

of one of the primaries resulted in a color deviation, which became noticeable at a deviation of  $0.006 \Delta u'v'$ .

In the second experiment, a strip of 23 LEDs was used to create spatial gratings on a white wall. The gratings varied in hue, saturation or luminance around a base color (red, green or blue) at a spatial frequency of 0.4, 0.6 and 1.2 cycles/degree. Participants had to judge whether the pattern appeared to be uniform or not. The results revealed that the visibility threshold for luminance gratings, expressed as the Michelson contrast, decreased with increasing spatial frequency in the range measured. Hence, the sensitivity to luminance contrast, expressed as the inverse of the Michelson contrast, increased with frequency (see Figure 4a). This is in agreement with literature. The visibility threshold for color gratings, expressed as the maximum color difference  $u'v'$ , was independent of the spatial frequency in the range measured for hue gratings but decreased with increasing frequency for saturation grating (see Figure 4b). This again shows that color deviations in hue and saturation give rise to different results.

The experiments show that the visibility threshold of a Gaussian-shaped color deviation in a uniform light field has the same order of magnitude as the often-used MacAdam ellipses, in spite of the large differences in stimuli and measurement method. However, the MacAdam ellipses are not reliable to predict the visibility of a regular color pattern, as it strongly depends on spatial frequency, type of deviation (luminance, saturation or hue) and base color.

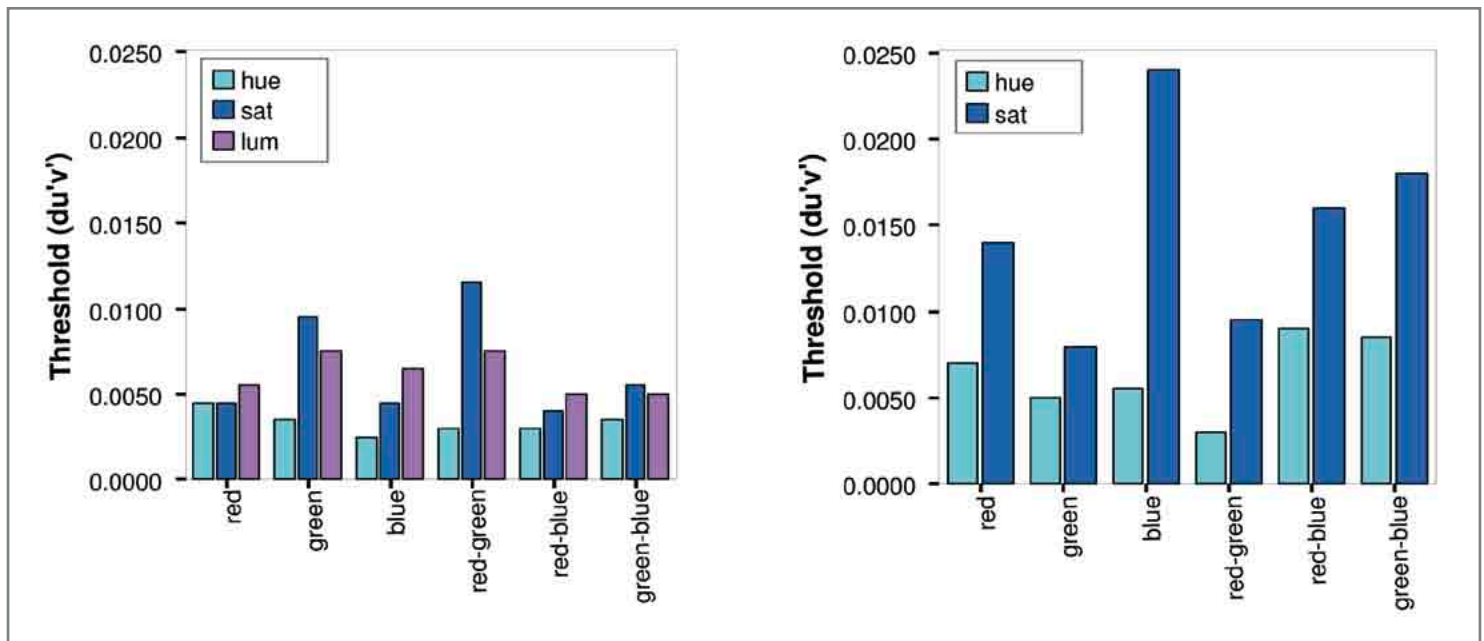

Figure 3: Average visibility threshold for deviations in the maximum luminance, hue or saturation of one primary (red, green, blue) or two primaries (red-green, red-blue, green-blue) of one RGB LED unit in an array of eight LED units when a white color is displayed (left) or when a saturated color is displayed (right).

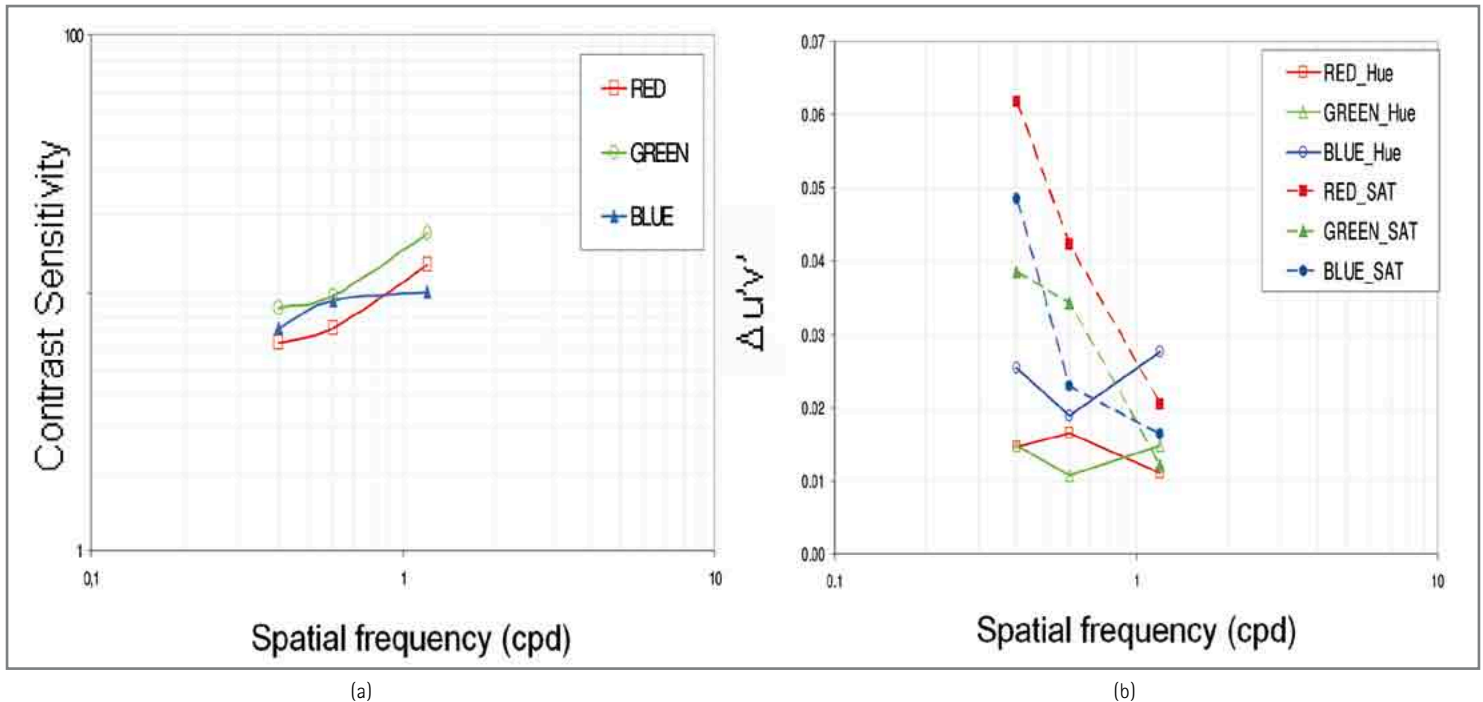

Figure 4: (a) Contrast sensitivity (= 1/michelson contrast) for luminance gratings as function of frequency and three base colors. (b) Average visibility threshold for hue gratings (solid lines) and saturation gratings (dotted lines) as function of spatial frequency for three base colors.

## Smooth dynamic light

The fast response time of LEDs makes them extremely suitable for creating dynamic light effects. However, since most LED systems are controlled by digital signals, the smallest distance between two colors, both in color and time, is limited. When the color difference or the time difference between two successive colors is too large, the temporal light transition will be perceived as jerky or discontinuous. In order to create visually appealing dynamic light effects with LEDs, knowledge on the perception of temporal light is needed. Extensive research exists on the sensitivity to flicker [5]. Flicker can be perceived when a light stimulus alternates in time between two colors with a color difference larger than a threshold value. It is not known whether similarities exist between the maximum color difference that is allowed to make an alternating pattern look steady and the maximum color difference that is allowed to make a color transition composed of discrete steps look smooth.

In order to gain insight into the perception of smoothness, two experiments were performed. In the first experiment, the sensitivity to discontinuities in linear temporal color transitions was measured. The color transitions varied in the direction of one of the CIE Lab color attributes (lightness, chroma or hue) around a base color. The effect of color attribute, frequency and lightness and chromaticity of the base color was investigated. Participants were instructed to indicate at which color difference the discrete steps became unnoticeable. This color difference (expressed in  $\Delta E_{ab}$ ) was defined as the visibility threshold.

### Annotation:

<sup>1</sup>  $\Delta E_{ab}$  corresponds to the geometric distance between two colors in the CIE Lab color space and can be calculated from the difference in Lightness ( $L^*$ ), the difference in Chroma ( $C^*$ ) and the difference in Hue ( $H^*$ ):

$$\Delta E_{ab} = \sqrt{\Delta L^* + \Delta C^* + \Delta H^*} = \sqrt{\Delta L^* + \Delta a^* + \Delta b^*}$$

As the amplitude and frequency of the light transitions were kept constant, the speed of the transition increased for increasing color difference. In the second experiment, the sensitivity to flicker for alternating color patterns was measured. The results are summarised in Figure 5.

The effects of color attribute, frequency and base color for smoothness perception were comparable to those for flicker perception, which suggests that similar mechanisms are involved. However, thresholds for smoothness perception were about 2.3 times larger (i.e. people are less sensitive) than those for flicker perception. Both thresholds were substantially smaller for variations in lightness compared to variations in chroma and hue and strongly depended on frequency. For lightness variations, thresholds decreased with increasing frequency towards a minimum value and then increased. In addition, lightness level but not chromaticity of the based color was found to have an effect. For chroma and hue variations, thresholds increased monotonically with frequency and were affected by base color chromaticity. However, the effect was different for chroma and hue. The visibility thresholds for smoothness perception were transformed in terms of the maximum speed ( $\Delta E_{ab}$  per second) that is allowed for a given color transition. The maximum speed exponentially increased with frequency with an exponent of  $0.13 \times \text{frequency}$ , independent of the color attribute that was varied.

The results of these experiments show that smooth light effects can be created by selecting the right combination of frequency, color difference and/or maximum speed of the light transition.



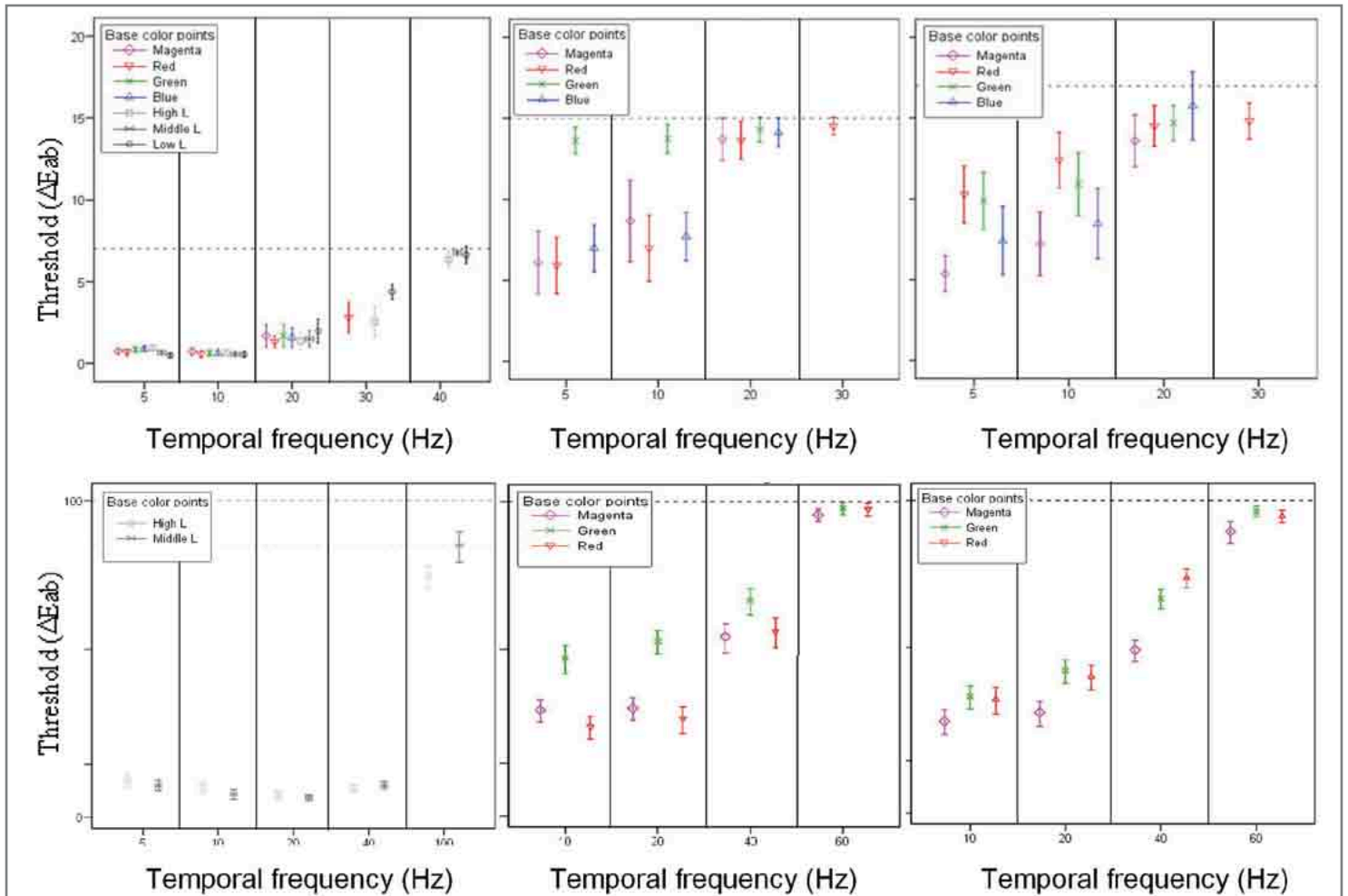

Figure 5: Visibility thresholds (in  $\Delta E_{ab}$ ) of smoothness perception (upper row) and flicker perception (lower row) as function of frequency for (a) lightness transitions, (b) chroma transitions and (c) hue transitions. The error bars correspond to the 95% confidence intervals.

## Appealing dynamic light

As mentioned, LEDs are especially suitable to create dynamic light. Various lighting applications, such as Ambilight TV and decorative lighting, generate dynamic light effects by fading between two colors. However, there are many different ways to generate a temporal transition between two colors in a three-dimensional color space. Most lighting systems create dynamic light effects by linearly interpolating between a begin and end color in the RGB color space. However, since RGB is a device dependent color space, the actual color transition will depend on the physical characteristics of the light source. A second drawback is that RGB is not a perceptually uniform color space. Hence, there might be better ways to generate temporal color transitions that are visually appealing to human observers. Currently, there is not much scientific knowledge on the perception of temporal light effects. Therefore, a study was performed to determine guidelines for the design of appealing temporal color transitions. In order to study what color transitions are preferred, one should know what color transitions can be distinguished. It makes no sense to ask people which of two temporal light effects they prefer, if they cannot see the difference. Therefore, two experiments were performed. The first experiment

investigated the ability to distinguish between two temporal color transitions. The results were used in the second experiment to develop six algorithms to create temporal color transitions. Participants indicated which of two successively presented algorithms they preferred most.

In the first experiment, two temporal transitions were shown after each other with the same begin and end colors: a reference transition with intermediate colors located on a straight line in CIE Lab, and a test transition with intermediate colors located on an arc defined in one of two planes: 1) the plane through begin and end color parallel to the lightness axis, called the lightness-plane, and 2) the plane through begin and end color perpendicular to the first plane, called the chromaticity-plane (see Figure 6a). Colors of the test transitions in the lightness-plane had equal hue and chroma compared to those of the reference transition. However, the lightness of the colors was larger (L+) or smaller (L-). Colors of test transitions in the chromaticity-plane had the same lightness compared to those of the reference transition. However, the colors varied in hue and chroma. The arc could bend towards the center of the gamut (Cin) or towards the boundaries of the gamut (Cout). Figure 6b shows examples of the directions Cin and Cout for each of the color pairs that were used in the experiment. Each transition

consisted of three phases: first, the begin color was shown for 2 seconds, then the color transition was shown for 0.5 or 4 seconds, and finally the end color was shown for 2 seconds.

The maximum color difference between the reference and test transitions at which they were perceived as different was defined as the discrimination threshold. Thresholds ranged between 2.5 and 12.5  $\Delta E_{ab}$ , dependent on the color pair, direction and the duration of the transition (see Figure 7). Hence, in most situations thresholds were larger than those for spatially separated color patches, which are usually around  $\Delta E_{ab} = 1$  [4]. Thresholds increased with duration for the transitions with lightness variations and slightly decreased for transitions with chromatic variations.

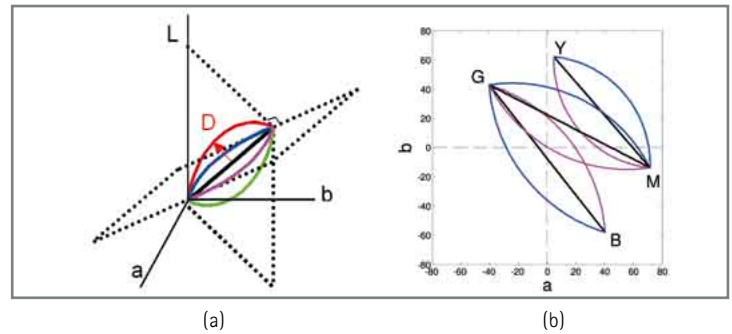

Figure 6: (a) Examples of the reference transition (black line) and the test transitions with direction L+ (red arc), L- (green arc), Cin (magenta arc) and Cout (blue arc). (b) Projection of the reference transition and test transitions Cin and Cout on the ab-plane for each color pair (blue-green, green-magenta and magenta-yellow).

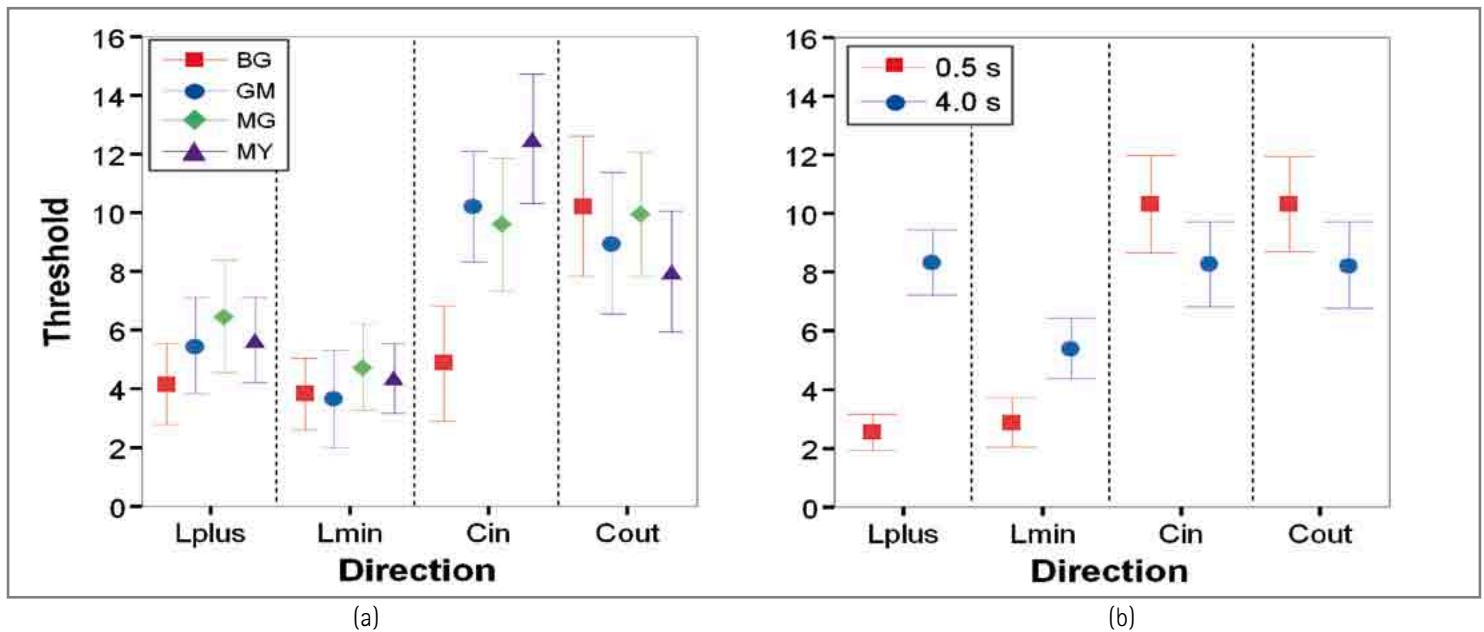

Figure 7: Discrimination threshold (in  $E_{ab}$ ) as a function of the direction of the test transition (a) per color pair (BG=blue-green; GM=green-magenta; MG=magenta-green; MY=magenta-yellow) and (b) per duration of the transition. The error bars correspond to the 95% confidence intervals.

In the second experiment six different algorithms to create temporal color transitions were compared: a linear transition in CIELab, a linear transition in RGB and the four test transitions of experiment 1 with a color difference of 3 times the discrimination threshold. Two color pairs (blue-green and magenta-yellow) were tested at a transition duration of 4 s. The most preferred transition was a linear interpolation in CIELab. A linear interpolation in RGB was also evaluated relatively high. However, since RGB is a device dependent color space, the evaluation might be quite different for a lighting system with different chromaticities of the primaries. In general, transitions for which the intermediate colors deviated clearly from the begin and end colors were not preferred.

## Conclusions

LED applications can substantially benefit from knowledge on visual perception in order to create appealing light effects. The presented perception studies show that spatial light effects are perceived as uniform when color differences are smaller than at least  $0.005 \Delta u'v'$ . In some situations larger deviations are allowed. Secondly, dynamic light effects are perceived as smooth when the temporal frequency is larger than a threshold value that depends on the speed of the color transition. Thirdly, two temporal color transitions are perceptually indistinguishable when the maximum color difference is smaller than at least  $2.5 \Delta E_{ab}$ . In some situations larger deviations are needed to see the difference. Finally, temporal color transitions are appealing when the intermediate colors are perceptually close to those of the begin and end colors. ■

**References:**  
 [1] MacAdam D.L. (1942). Visual sensitivities to color differences in daylight. *Journal of the Optical Society of America*, 32, 247-275.  
 [2] Campbell F.W. and Robson J.G. (1968). Application of Fourier analysis to the visibility of gratings. *Journal of Physiology*, 197, 551-566.  
 [3] Mullen K.T. (1985). The contrast sensitivity of human color vision to red-green and blue-yellow chromatic gratings. *Journal of Physiology*, 359, 381-400.  
 [4] M.D. Fairchild, *Color Appearance Models* (Addison-Wesley, 2005).  
 [5] Lange, H. (1958). Research into the dynamic nature of the human fovea-cortex systems with intermittent and modulated light: I. Attenuation characteristics with white and colored light. *Journal of the Optical Society of America*, 48, 777-784.

# Measurement of LEDs

> Yoshi Ohno, Cameron Miller, and Yuqin Zong, National Institute of Standards and Technology

## Introduction

Various new types of light emitting diodes (LEDs) are being developed and introduced for general illumination and other applications, and there are increasing needs for accurate measurements of various optical parameters of LEDs. Traditional standard lamps do not meet the calibration needs for LED measurements as LEDs differ substantially from traditional lamps in terms of physical sizes, flux levels, spectra, and spatial intensity distributions. The temperature-dependent characteristics and great variability of optical designs of LEDs make it even more difficult to reproduce measurements. To assure high accuracy LED measurements, reference standard LEDs and calibration services have been in high demand [1]. The National Institute of Standards and Technology (NIST) has recently developed and expanded capabilities for calibrating LEDs for photometric, radiometric, and colorimetric quantities and provides various calibration services for LEDs. This article discusses measurement of luminous intensity, total luminous flux, total spectral radiant flux, and color quantities of LEDs, as well as NIST measurement facilities and calibration services for LEDs.

## Luminous Intensity

The luminous intensity (unit: candela) of LEDs can be measured with a conventional photometric bench and the standard photometers [2] under a far field condition, at a distance far enough so that the test LED can be regarded as a point source (typically 2 m or longer). However, a common practice in the LED industry has been to measure LEDs at much shorter distances, such as 10 cm to 50 cm. The tradition presumably came from the time when LEDs were very dim and photometers were not very sensitive. This practice still prevails even though LEDs are much brighter. Measuring luminous intensity of LEDs at short distances is problematic because many LEDs have epoxy lenses, and they do not behave as a point source and the inverse-square law does not hold well. The effective center of LED emission can shift from the physical center of the LED. This causes variations in measured luminous intensity when measured at different distances, especially when the distance is short. This was determined to be one of major causes of variation in luminous intensity measurement.

To address this problem, the Commission Internationale de l'Éclairage (CIE) standardized the measurement distances (100 mm and 316 mm) for LED intensity measurements as published originally in CIE 127 (1997) and in recent revision CIE 127:2007 [3]. This publication also standardized the photometer aperture to be circular with an area of 1 cm<sup>2</sup>, the distance is to be measured from the tip of the LED encapsulation, and the direction of measurement is to coincide with the mechanical axis of the LED. This CIE geometry is shown in Figure 1.

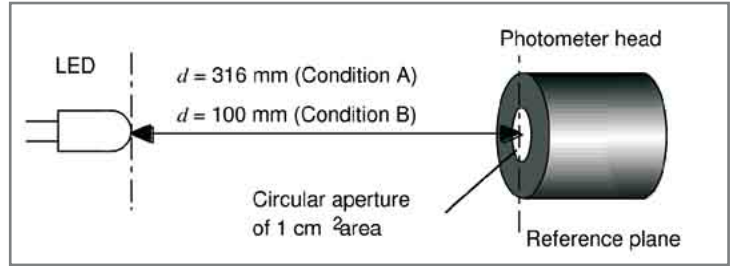

Figure 1: Geometry for CIE Averaged LED Intensity

The luminous intensity measured under these standardized conditions is called the CIE Averaged LED Intensity, since the value can be slightly different from the real (far-field) luminous intensity of the LED. The two distances are distinguished by Condition A and Condition B, for 316 mm and 100 mm, respectively. This CIE recommendation should be used for intensity specification of individual LEDs. This recommendation does not apply for LED clusters, arrays, and fixtures made with LEDs. Test LEDs are measured against calibrated standard LEDs or a calibrated standard photometer head, with spectral mismatch correction applied as necessary.

NIST has developed standard photometers in compliance with this CIE recommendation, and has established a calibration service for Averaged LED Luminous Intensity in Conditions A and B. The uncertainty (expanded uncertainty,  $k=2$ ) for these calibrations is typically 1 % to 3 % depending on test LEDs. See references [4-7] for details.

## Total luminous flux

The total luminous flux (unit: lumen) is probably the most important quantity for LEDs used for illumination applications. The luminous efficacy, lumens per watt, is critical for white LEDs being developed. Compared with measurements of traditional incandescent lamps, the uncertainties of LED measurements tend to be much larger, primarily due to narrowband spectral distributions and varieties of beam pattern of LEDs. Total luminous flux of LEDs can be measured either with an integrating sphere system or a goniophotometer. When using integrating spheres, it has been common practice in the LED industry to mount LEDs on the sphere wall. This method is inappropriate in many cases, as the backward emission of the test LED is excluded and total luminous flux is not measured correctly. In the new recommendation CIE 127:2007 [3], the integrating sphere geometries as shown in Figure 2 are recommended. In cases where only forward flux is important, partial LED flux is defined also in the new CIE publication.

Geometry (a) in Figure 2 is recommended for all types of LEDs including those having a narrow beam profile or those having broad and backward emissions. This geometry should be used for most of the 5 mm epoxy type LEDs, which have backward emissions. Geometry (b) is acceptable for LEDs having no backward emission. For example, a high-power LED having a large heat sink and no backward emission can be measured with geometry (b) where only the LED head is inserted into the sphere and the large heat sink stays outside the sphere. Integrating spheres with either geometry should be calibrated with a total luminous flux

standard LED having a similar angular intensity distribution and spectral distribution as the test LEDs to be measured, with spectral mismatch corrections applied as necessary. Integrating spheres with size from 20 cm to 50 cm are commonly used for LEDs.

Total luminous flux of LEDs are calibrated at NIST using the 2.5 m integrating sphere system, which is also used for the realization of the lumen and calibration of traditional lamps. Even with the very large size of the sphere, the sphere system has sufficient sensitivity for LED luminous flux measurement. The 2.5 m sphere system uses the Absolute Sphere Method as shown in Figure 3. The spectral throughput of the NIST sphere has been precisely determined and spectral mismatch correction is applied. The errors due to spatial nonuniformity of the

and backward emissions. This geometry should be used for most of the 5 mm epoxy type LEDs, which have backward emissions. Geometry (b) is acceptable for LEDs having no backward emission. For example, a high-power LED having a large heat sink and no backward emission, can be measured with geometry (b) where only the LED head is inserted into the sphere and the large heat sink stays outside the sphere. Integrating spheres with either geometry should be calibrated with a total luminous flux standard LED having a similar angular intensity distribution and spectral distribution as the test LEDs to be measured, with spectral mismatch corrections applied as necessary. Integrating spheres with size from 20 cm to 50 cm are commonly used for LEDs.

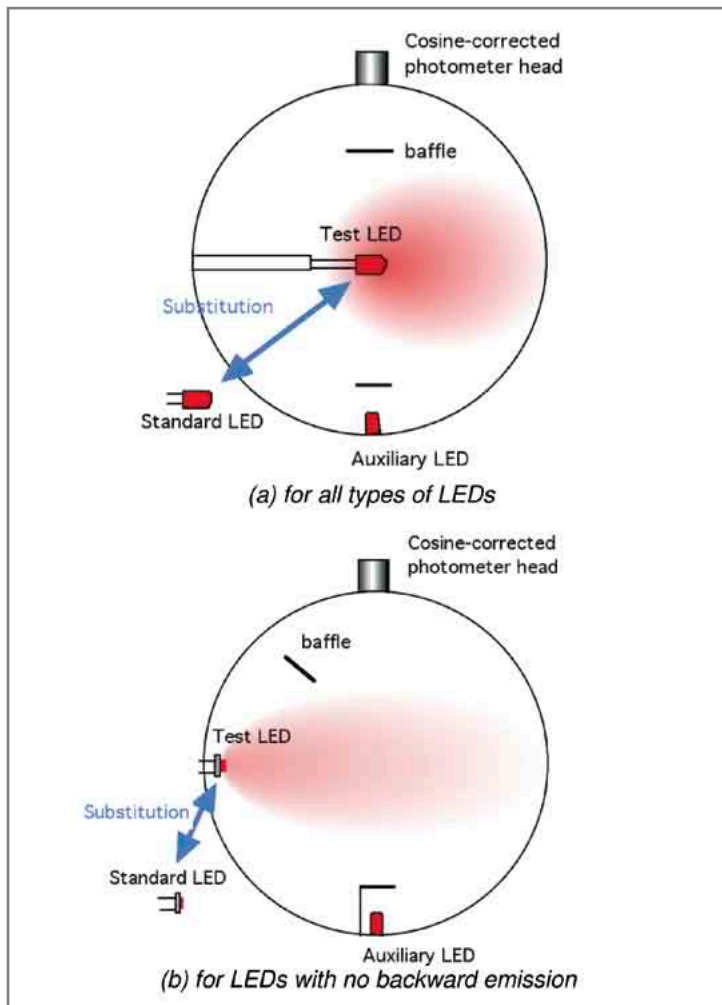

Figure 2: Recommended sphere geometries for LED total luminous flux measurement.

sphere responsivity, associated with differences in LED angular intensity distributions, have also been analyzed for correction or uncertainty determination. The uncertainty (expanded uncertainty,  $k=2$ ) for LED luminous flux calibration at NIST is typically 0.7 % for white LEDs and 1 % to 3 % for single color LEDs. The details of the NIST 2.5 m sphere [8] and the LED calibration procedures for luminous flux are available in references [4,9]. Geometry (a) is recommended for all types of LEDs including those having a narrow beam profile or those having broad

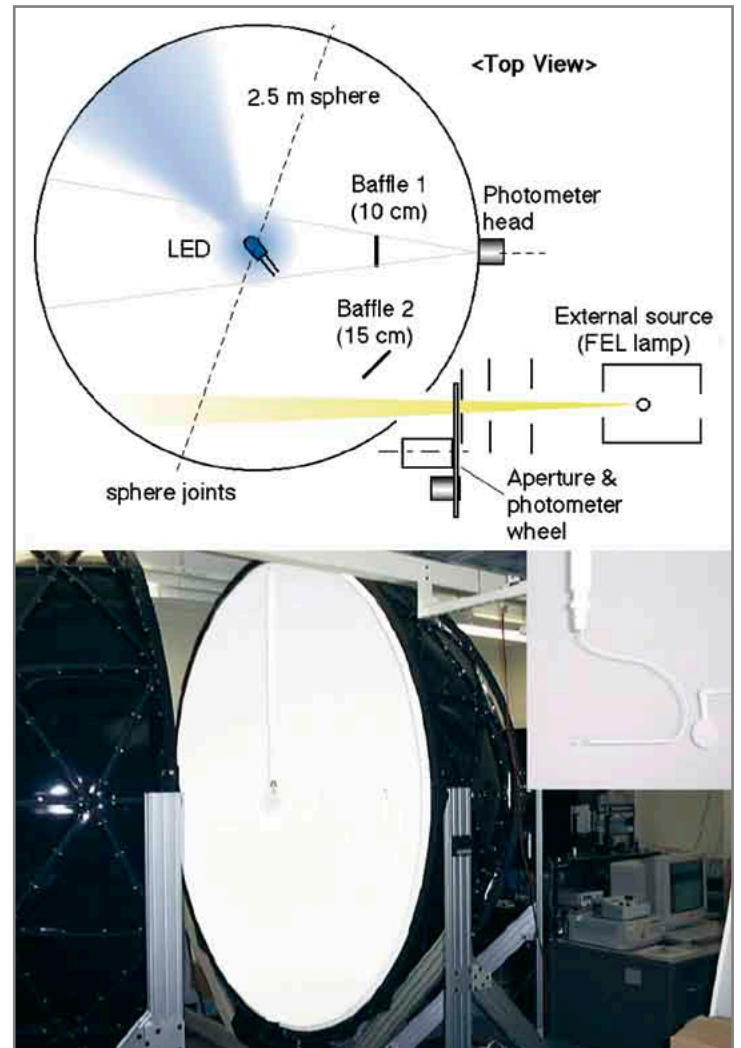

Figure 3: NIST 2.5 m integrating sphere configured for LED measurements (above) and the picture of the sphere with an LED holder (below).

Total luminous flux of LEDs are calibrated at NIST using the 2.5 m integrating sphere system, which is also used for the realization of the lumen and calibration of traditional lamps. Even with the very large size of the sphere, the sphere system has sufficient sensitivity for LED luminous flux measurement. The 2.5 m sphere system uses the Absolute Sphere Method as shown in Figure 3. The spectral throughput of the NIST sphere has been precisely determined and spectral mismatch

correction is applied. The errors due to spatial nonuniformity of the sphere responsivity, associated with differences in LED angular intensity distributions, have also been analyzed for correction or uncertainty determination. The uncertainty (expanded uncertainty,  $k=2$ ) for LED luminous flux calibration at NIST is typically 0.7 % for white LEDs and 1 % to 3 % for single color LEDs. The details of the NIST 2.5 m sphere [8] and the LED calibration procedures for luminous flux are available in references [4,9].

## Total Spectral Radiant Flux

Integrating spheres equipped with a spectroradiometer as the detector of the sphere as shown in Figure 4, called sphere-spectroradiometers, are increasingly used for measurement of LEDs. This is a convenient way of measuring photometric quantities and color quantities at the same time. This type of instrument measures total spectral radiant flux (unit:  $W/nm$ ), from which total luminous flux, total radiant flux, and color quantities (spatially integrated) are obtained. Another advantage is that total luminous flux can be measured theoretically with no spectral mismatch error. By using an array spectroradiometer, the measurement can be as fast as a sphere-photometer system. Such sphere-spectroradiometer systems need to be calibrated against a total spectral radiant flux standard.

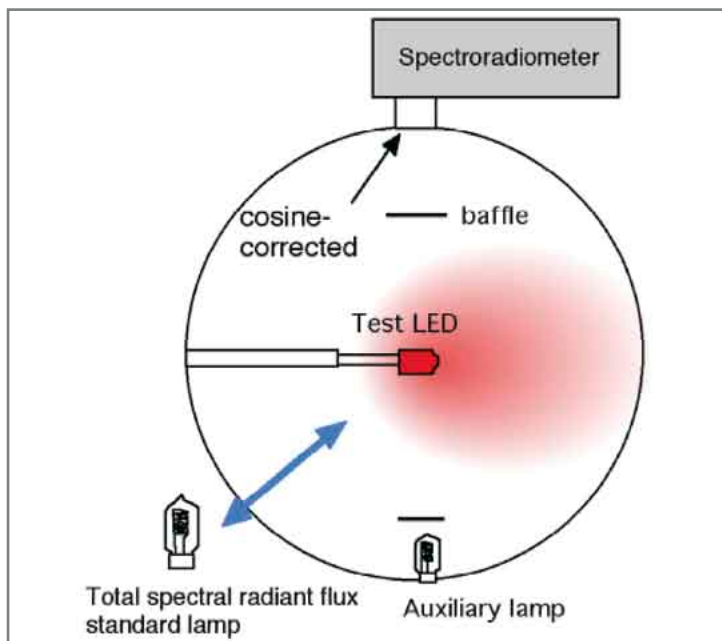

Figure 4: An example of a sphere-spectroradiometer system.

NIST has recently established a total spectral radiant flux scale for the 360 nm to 830 nm region, using a gonio-spectroradiometer system as shown in Figure 5, and offers calibration services [10]. The scale is disseminated by issuing calibrated total spectral radiant flux standard lamps (75 W quartz halogen lamps) and by providing calibration of lamps submitted by customers.



Figure 5: NIST gonio-spectroradiometer for the total spectral radiant flux scale realization

## Total Radiant Flux

Total radiant flux (unit: watt) is a spectrally and spatially integrated total radiant flux of a source. Radiant power and optical power are also often used for the same meaning for LEDs. This quantity is necessary to specify LEDs in the UV and IR regions, and is also useful for single color LEDs, as the values of lumen change dramatically depending on the peak wavelength even within the same color range making it difficult to compare the lumen values. For LEDs in the visible region, the total radiant flux can be converted from the luminous flux value and LED's relative spectral distribution. However, the uncertainty increases, especially at near the wings of the  $V(\lambda)$  function.

NIST provides calibration services for total radiant flux of LEDs in the 360 nm to 830 nm region using the NIST 2.5 m absolute sphere system configured for a total spectral radiant flux mode, as shown in Figure 6. The calibration is based on the NIST spectral irradiance scale. The spectroradiometer is a CCD-array type and is corrected for spectral stray light [11]. For the details for total radiant flux calibration, see reference [12].

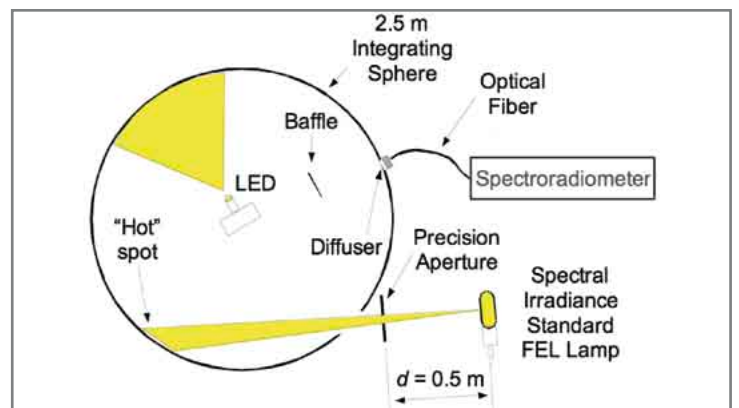

Figure 6: NIST 2.5 m sphere configured for total radiant flux and color calibration.

## Color Quantities

Color quantities such as chromaticity coordinates, dominant wavelength, correlated color temperature (for white LEDs), and Color Rendering Index (for white LEDs), are used to specify color characteristics of LEDs. Even if a spectroradiometer calibrated traceable to national standards is used, the uncertainty in measured color of LEDs is often unknown or unexpectedly large, and thus reference LEDs calibrated by national laboratories are often needed by users to verify the accuracy of LED color measurements.

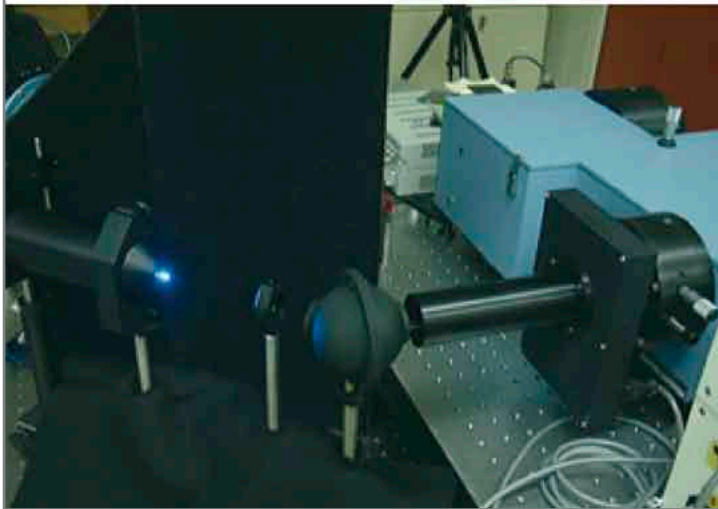
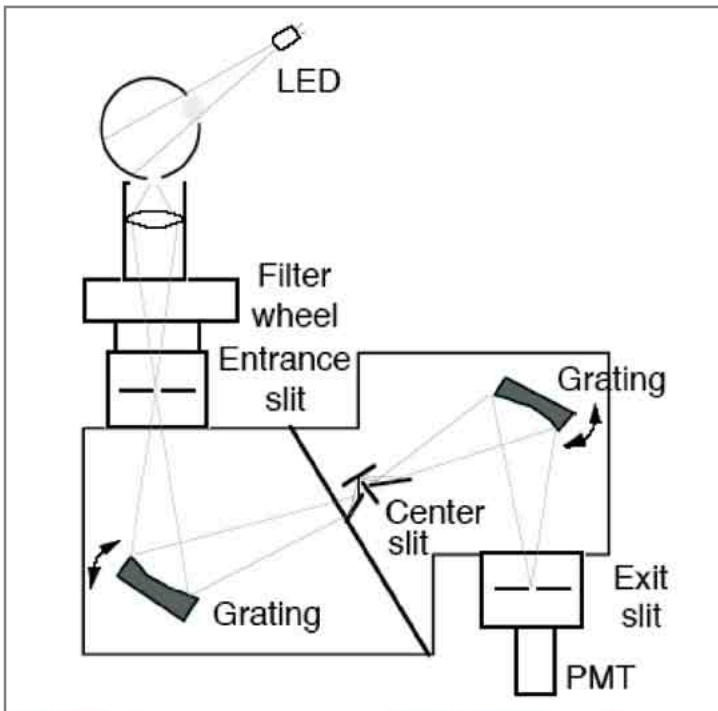

Figure 7: NIST reference spectroradiometer for LED color measurement.

NIST has developed a reference spectroradiometer for LED color measurement (CIE Condition B geometry), using a double-grating monochromator with irradiance input optics. This spectroradiometer is tuned to have a triangular bandpass of 2.5 nm width (FWHM) and scans at 2.5 nm intervals. The uncertainties in LED calibrations for any color

are within 0.001 in CIE ( $u'$ ,  $v'$ ) chromaticity. Figure 7 shows the optical design of the NIST spectroradiometer system. Further details on the reference spectroradiometer can be found in reference [13].

In addition to directional color calibration, spatially-averaged color quantities of LEDs integrated over the entire emission angles are available from the total spectral radiant flux measurement as described above. It is recommended that white LEDs be measured for spatially averaged values, as the color tends to shift with viewing angle. The spatially-averaged color quantities are measured at NIST using the facility described above for total radiant flux. Calibrations of either directional or spatially-averaged color quantities of LEDs are available from NIST.

## Strategy on standard LEDs in NIST calibration services

Some NIST calibration services issue calibrated artifacts and others calibrate artifacts submitted by customers. We decided not to prepare and issue "standard LEDs" because there are so many types of LEDs and new types of LEDs are continuously being introduced, and thus, any standard LED we might develop would not satisfy many customers and would quickly become obsolete. We are committed to providing calibrations for any type of LEDs submitted by our customers, which can then be used as reference standard LEDs of the type needed in the customer's lab. Customers are responsible to ensure the quality of LEDs submitted to NIST for calibration. Information on the NIST photometric calibration services is available on the website [14] or by contacting the authors. ■

### References:

- [1] CORM 7th Report, *Pressing Problems and Projected National Needs in Optical Radiation Measurements* (2001).
- [2] Y. Ohno, *NIST Measurement Services: Photometric Calibrations*, NIST Spec. Publ. 250-37 (1997).
- [3] CIE 127:2007 *Measurement of LED*, 2nd Edition (2007).
- [4] C.C. Miller, Y. Zong, and Y. Ohno, "LED Photometric Calibrations at the National Institute of Standards and Technology and Future Measurement Needs of LEDs," *Proc., SPIE Fourth International Conference on Solid State Lighting*, Denver, CO, August 2004, 5530, 69-79 (2004).
- [5] C.C. Miller and Y. Ohno, "Standardization of LED measurements," *LEDs Magazine*, November 2004, and in *Photonics Spectra*, v. 38/9, p.68, (2004).
- [6] C.C. Miller, T. Heimer, Y. Zong, Y. Ohno, and G. Dezsi, "Development of LED Photometric Standards at NIST," *Proc. 25th Session of the CIE*, San Diego, Volume 1, D2 108-111 (2003).
- [7] C. C. Miller and Y. Ohno, *Luminous Intensity Measurements of Light Emitting Diodes at NIST*, *Proc. 2nd CIE Expert Symposium on LED Measurement*, May 11-12, 2001, Gaithersburg, Maryland, USA, 28-32 (2001).
- [8] Y. Ohno and Y. Zong, "Detector-Based Integrating Sphere Photometry," *Proceedings, 24th Session of the CIE Vol. 1, Part 1*, 155-160 (1999).
- [9] C. C. Miller and Y. Ohno, *Luminous Flux Calibration of LEDs at NIST*, *Proc. 2nd CIE Expert Symposium on LED Measurement*, May 11-12, 2001, Gaithersburg, Maryland, USA, 45-48 (2001).
- [10] Y. Zong and Y. Ohno, *Realization of total spectral radiant flux scale and calibration service at NIST*, *Proc., the 26th Session of the CIE in Beijing, China*, July 4-11, 2007, Vol. 1, pp. D2-179 to D2-182 (2007).
- [11] Y. Zong, S. W. Brown, K. R. Lykke, and Y. Ohno, *Simple Stray Light Correction Method for Array Spectrometers*, *Applied Optics*, Vol. 45, Issue 6, pp. 1111-1119 (2006).
- [12] Y. Zong, C. C. Miller, K. Lykke, and Y. Ohno, *Measurement of Total Radiant Flux of UV LEDs*, *Proceeding of the CIE Expert Symposium on LED Light Sources*, June 2004, Tokyo, 107-110 (2004).
- [13] Y. Ohno and B. Kránicz, *Spectroradiometer Characterization for Colorimetry of LEDs*, *Proc. 2nd CIE Expert Symposium on LED Measurement*, May 11-12, 2001, Gaithersburg, Maryland, USA, 56-60 (2001).
- [14] [http://physics.nist.gov/Divisions/Div844/facilities/photo/sp250\\_chap7.htm](http://physics.nist.gov/Divisions/Div844/facilities/photo/sp250_chap7.htm)



# LED CHINA 2008

—The Toppest Global Event for LED Application



Time : March 4 -6, 2008

Venue : China Import and Export Fair Pazhou Complex, Second Phase  
(No. 380, Yue Jiang Zhong Rd, Haizhu District, Guangzhou, China)

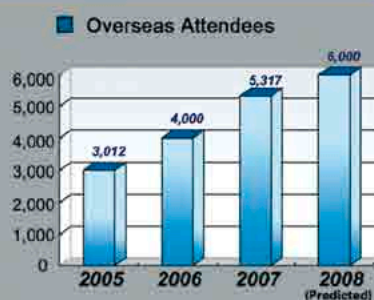
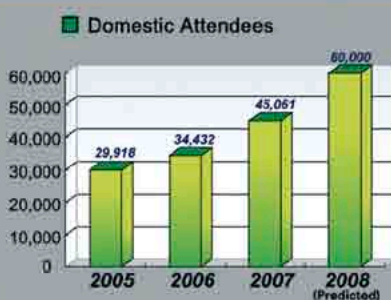
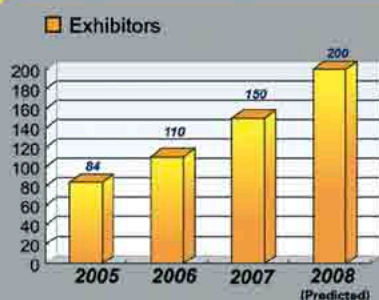

## Latest News:

Up until November 15<sup>th</sup>, 2007, 130 companies have participated in LED CHINA 2008. It's predicted that the final number of exhibitors will be up to 200.

## Concurrent Activities

- SIGN CHINA 2008
- NEON SHOW 2008

*In return for great support of visitors, the first 100 companies who pre-register on [www.LEDChina-gz.com](http://www.LEDChina-gz.com) will get one complimentary show catalogue on site.*

[www.LEDChina-gz.com](http://www.LEDChina-gz.com)

Trust Exhibition Co., Ltd.

Contact person: Miss Grace Zhou (ext. 820)

Tel : +86-20-3810 6261, 3810 6263

Fax: +86-20-3810 6200

Email: LED@TrustExhibition.com

Website: [www.LEDChina-gz.com](http://www.LEDChina-gz.com)



## Technology

# High Performance Multi-Color LEDs in Chip-On-Board Technology

> Oliver Kückmann and Jörg Hannig, PerkinElmer Elcos GmbH

Since 1962, when the first red Gallium-Arsenide-Phosphide (GaAsP) light-emitting diode (LED) was produced, a great deal of time, money and effort has been spent on developing more efficient LEDs to compete with other light sources. By 2000, "power chips," or "high-current chips" were developed for serial production. These chips enabled LEDs to effectively penetrate a variety of markets for different white and color lighting applications.

High-performance LEDs, designed and manufactured as multi-chip high-power LEDs in chip-on-board (CoB) technology, are a brilliant example of multifunctional devices for white and color LED applications. Obviously, specific requirements must be met for developing such high-power LEDs. Most of the electrical input power is converted into heat, which makes thermal management a key consideration. Also, intelligent optical layout of the LED is crucial since this enables increased efficiency as well as optimal color-mixing quality.

Whereas conventional illuminants, such as light bulbs, halogen or fluorescent light sources, show continuous spectra and generate mostly unwanted infrared (IR) radiation, color LEDs have more discrete spectra and need a heat conductive process to eliminate generated heat. A more detailed explanation is provided later in this article.

Of course, LEDs are the more favored solution regarding effectiveness for colored applications because they do not need the additional filtering that is characteristic of conventional light sources. Color LEDs can even be useful in applications that require white light or with a high color-rendering index.

## Design and construction

In the design and construction of a high-performance, multi-color LED in COB technology, an LED design with four high-power chips (sized ~ 1x1 mm<sup>2</sup>) is an excellent solution due to its optical performance and multi-functionality. An adequate LED board can, for instance, be based on an insulated metal substrate (IMS) made from copper and a highly-sophisticated isolation material with a low thermal resistance between the copper and chip pads. Such a package provides excellent heat dissipation and thermal management from the chip to the board's backside. The thermal resistance ( $R_{th,JB}$ ) of an entire package is quite low (~4.5 K/W), depending on the chip configuration. To dissipate the heat, adequate cooling must be considered. To avoid overheating damage to LED chips equipped with at least one high-power LED chip, the LED must not run without appropriate cooling – even at lower currents.

Figure 1 shows the typical layout of a high-performance, multi-color LED. The chips are placed in the middle of the board, protected by a PPA-based ring and silicone resin encapsulation. The latter is transparent and suitable for a wide radiation range from ultraviolet (UV) to IR. These characteristics achieve superior light radiation resistance, degradation mitigation, and the ability to maintain LED color purity over the LED's lifetime.

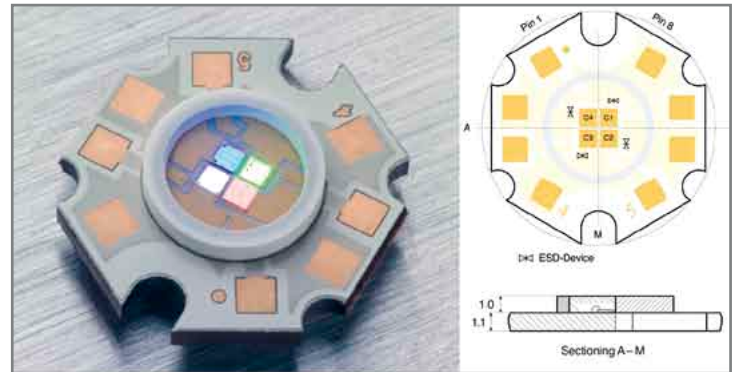

Figure 1: Example for high-performance multi-color LED in CoB (PerkinElmer's ACULED VHL RGBW)

The distance between the LED chips should be minimal and, in special cases, may be down to 0.1 mm for achieving the best color mixing. To allow all four chips (and colors) to be operated and adjusted separately for maximum flexibility of the electrical driving layout, each chip should have a separate anode and cathode. If electro-static discharge (ESD)-sensitive LED chips are implemented in a package, ESD protection diodes can enhance reliability and should, therefore, be optionally available in any high-performance LED package.

A design with four closely-placed chips (see Figure 1) will have a small, but bright, light-emitting area that achieves excellent color mixing with multi-color configurations. A high-precision chip placement with less than 20 µm placement tolerance to a reference mark makes it a superior and reliable light tool, especially when used with optics. For easy and cost-effective process flow, the high-performance, multi-color LED should be supplied in a package that allows automatic pick-and-place processing, such as a standard blister tape.

Modern high-power LED chips that are mandatory for high-performance LEDs have efficiencies of 10% to 20% of radiation output at common operation conditions. Thus, 80% to 90% of the electrical energy is transformed into heat. In contrast to incandescent lights, almost no heat is radiated into the LED's environment in terms of IR radiation. However, during operation, heat is still generated and has to be mitigated by thermal conduction to avoid undesirable effects, or even destruction, of the LED chip.

Besides helping to avoid chip damage from overheating, good thermal management helps handle all parameters impacted by temperature, including:

- life time [ $t_{Life}$ ] / degradation
- forward voltage [ $V_f$ ]
- flux [ $\Phi_e$  and  $\Phi_v$ ]
- wavelength [ $\lambda$ ] resp. color [ $x_2$ , /  $y_2$ ] and color temperature (TCT).



It is essentially to work under stable conditions that reduce degradation, forward voltage drift, flux instabilities and wavelength shift, particularly during color mixing of a multi-color LED. To achieve optimal performance, it is, therefore, helpful to minimize thermal crosstalk between the LED chips, much like in an excellent LED-array. With low thermal crosstalk, the heating up of one LED chip has minimal effect on neighboring chips, resulting in excellent constancy in the parameters described above.

The LED array must be attached to a heat sink or heat-conducting board. Besides mechanical stability, cooling is the key consideration of the assembly process. The heat must be drawn away from the LED board by conduction. A good physical contact between the substrate and the heat sink must be established for adequate heat transport. Because of this need for good contact, screwing is the best choice for mounting whenever possible. The mounting technique should also consider the stability required by the application. Mobile execution with higher vibration, for example, requires more stability than stationary applications.

### Influence on lifetime

Overheating an LED chip, such as exceeding its junction temperature ( $T_j$ ) over the allowable maximum, will damage the chips within a short time. But long-term temperature effects also influence lifetime. During operation, a lower temperature corresponds with a longer chip lifetime and, in turn, a longer lifetime for the entire color LED product. Some degeneration processes require a minimum temperature, thus, a low  $T_j$  will dramatically increase the product's lifetime. Since these processes are very complex and not fully understood today, it's virtually impossible to get reliable curves of  $t_{life}$  versus  $T_j$  for a longer period of time.

### Influence on forward voltage

The forward voltage ( $V_f$ ) typically decreases in the range of several mV per Kelvin with increased temperature. The temperature-induced forward voltage variation can be assumed as linear over the typical temperature changes during operation. The typical curves for red, green and blue chips (see Figure 2) show that this issue should be considered for multi-color LED designs with appropriate electrical circuitry.

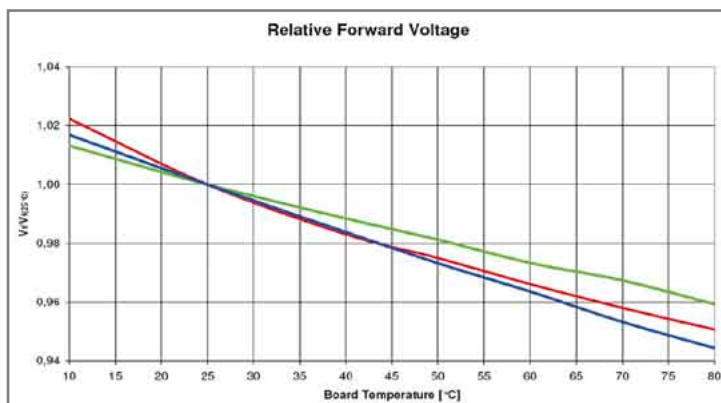

Figure 2: Relative forward voltage versus LED board temperature TB for red, green and blue chips (ACULED)

### Influence on flux and intensity

The flux ( $\Phi_e$ ) and ( $\Phi_v$ ), along with their deducted values, such as luminance, radiance, luminous intensity or radiant intensity, decreases with increasing temperature. Generally speaking, the intensity drop of blue and green Indium-Gallium-Nitride (InGaN)-based chips is usually small, whereas the drop with yellow, amber and red Aluminum-Indium-Gallium-Phosphide (AlInGaP)-based chips is larger. Figure 3 shows typical curves representing the relative luminous drift for the chips of an RGYB four-chip LED.

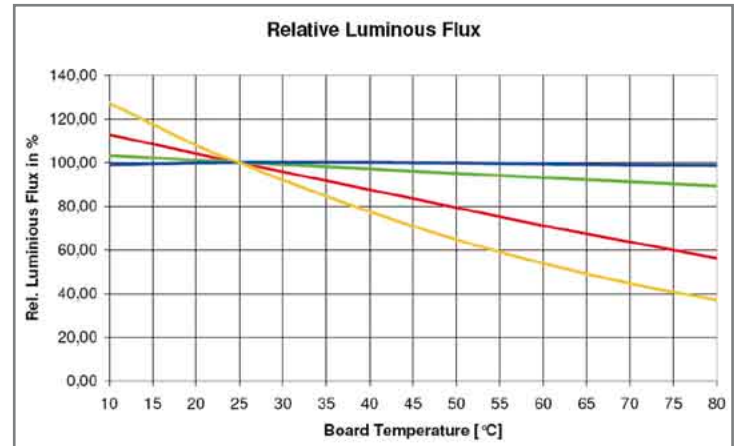

Figure 3: Change of relative luminous flux vs. board temperature TB for the chips of a RGYB-LED

If a certain flux is necessary in an application, it's important to level out the temperature-based intensity drop. A good thermal management also helps the drift to stay as low as possible. The balancing of the drift over temperature is important, particularly when using chips of different colors on an LED, such as RRGB or RGYB. It helps maintain the same intensity ratio and, therefore, the same color appearance. With the RGYB, for example, the color mix drifts to a blue-greenish light with increasing temperature, since yellow and red fade out much more than blue and green (see Figure 3). If the LED-package shows no thermal crosstalk between the chips, as described above, each chip can be leveled out individually without regard for its temperature or heating effects on neighboring chips.

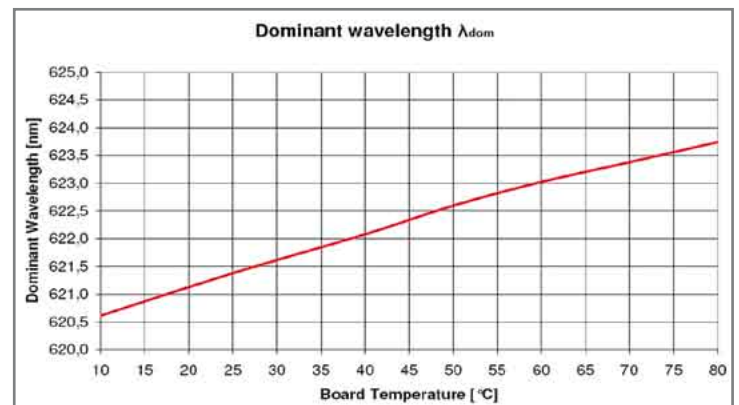

Figure 4: Change of peak wavelength vs. substrate temperature TB for the chips of a RGYB-LED

Besides changing the mixed color ratio due to the different intensity changes, each chip also changes color as a result of wavelength drift caused by temperature (see Figure 4).

Consideration for the above-mentioned aspects will enable the design and manufacture of tunable high-performance, multi-color LEDs that can penetrate various applications. These applications include architectural and landscape lighting; entertainment and mood lighting; medical and operational lighting; and displays or signs. With the high requirements of entertainment or operational medical lighting, for example, a brilliant color reproduction is required. The comparison below of different light sources with high-performance, multi-color LEDs underscores the multi-functionality of the latter LED-types.

### Color rendering of different light sources

As a simplified qualitative approach, different well-known light sources can be observed for their ability to reproduce the different colors of a color stripe master lit by the source.

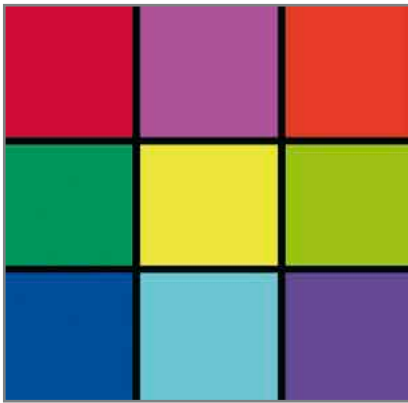

Figure 5: Color master, divided into different groups of red, green and blue.

As first light source, a well-known commercial incandescent light with approx. 2800K correlated color temperature is chosen. Taking the spectrum (see Figure 6) of such a light source, it is easy to recognize the nearly linear behavior. It has a predominant part of red and, therefore, leads to that nice warm white that is very comfortable for the human eye. As expected, red colors are highlighted by the light source (see Figure 6). For blue colors, the light source generates weak blue tones and even shifts the green colors to warmer yellowish. Halogen light sources generally show this behavior with slightly a different color temperature of approximately 3200K. If unfiltered, neither would be useful for medical operational lamps since the requirements dictate a white with higher color temperature.

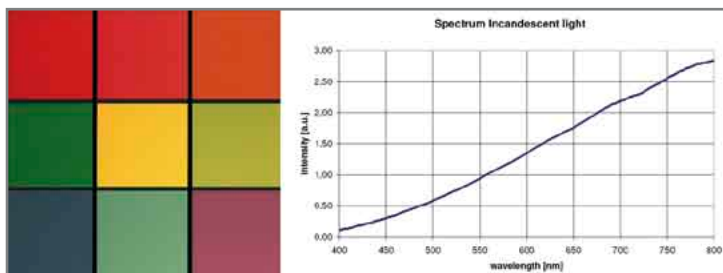

Figure 6: Color rendering of a light bulb and spectrum of incandescent light

Choosing a standard fluorescent lamp as a light source, the continuous, but rippled, spectrum can be observed with various spikes (see Figure 7). Along with the very sharp spikes, there is also a reasonably flat spectrum across the entire visible wavelength range. The corresponding color rendering, shown in Figure 7, shows acceptable color diversity. However, the quality of the color rendering strongly depends on the spectrum of the specific fluorescent lamp and can be up to 90%.

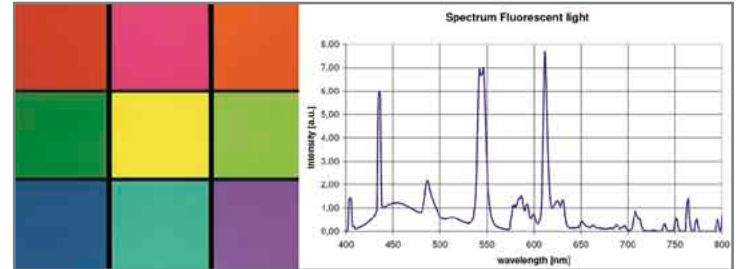

Figure 7: Color rendering of a fluorescent tube and spectrum of a fluorescent tube

In contrast to observed light sources with continuous spectra, LEDs with their discrete spectra will be analyzed in more detail. The most traditional method for achieving white light with acceptable color rendering is to take blue LEDs with a yellow converter. The converter can either be directly attached on the LED chip or placed above as volume coating or layer for other attached components. To achieve the best efficacy, converter materials for cold white LEDs are typically used instead of warm white converter materials that are less efficient. The typical spectrum of a cold white LED is shown in Figure 8, lacking cyan and red colors in the spectrum. The corresponding color rendering of the master underscores the weak performance for the illumination of red objects.

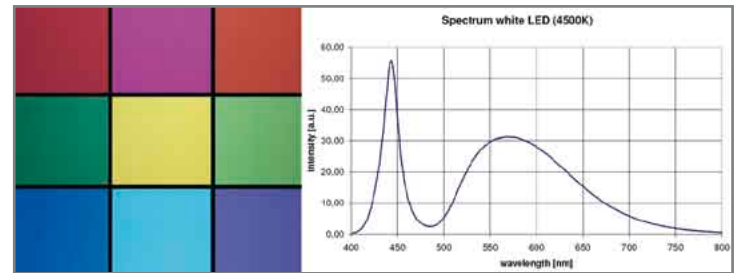

Figure 8: Color rendering of a cold white LED and spectrum of a cold white LED

An alternative method for achieving white with LEDs is to use an RGB LED. The LED's spectrum is shown in Figure 9. For this particular LED, four very tightly placed chips, including two green, are used. The configuration and performance of all chips within this RGB-LED lead to a white light generation when operating each chip close to the maximum rated current. The color rendering performance (see Figure 9) is limited by the "discrete" spectra of the single-color LEDs and shows limited performance on yellow. However, the red and blue LEDs show excellent performance and high brilliance.

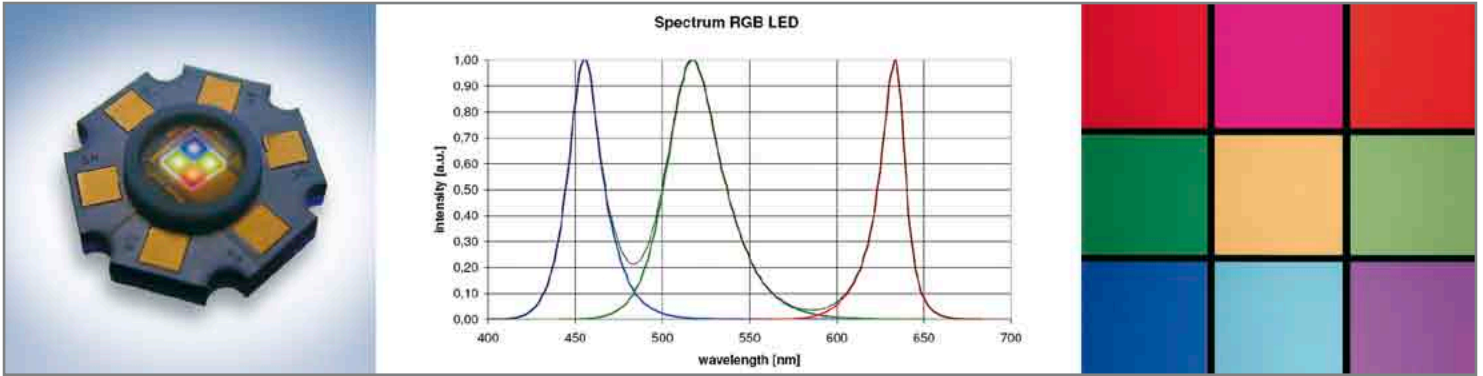

Figure 9: RGG LED ACULED (left): Spectrum (middle) and color rendering (right)

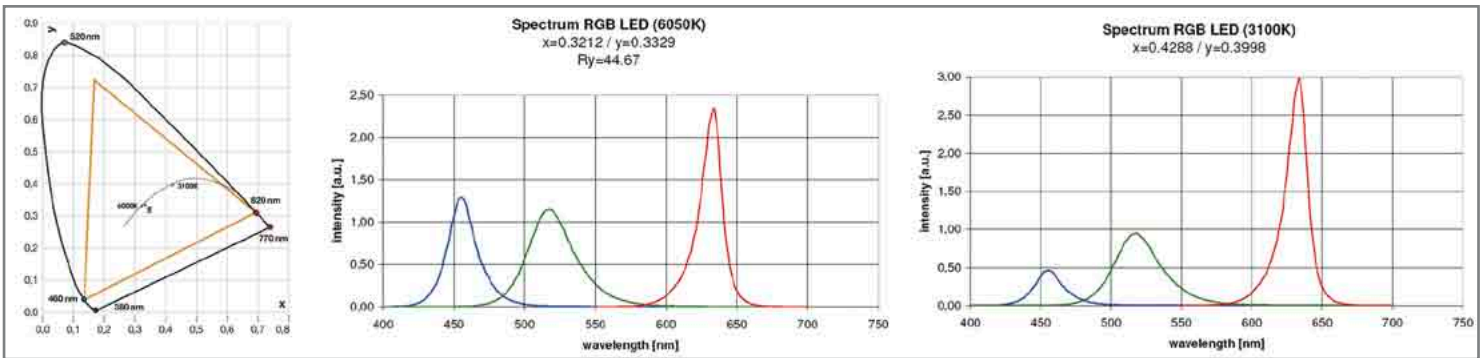

Figure 10: Achievable chromaticity coordinates within CIE 193 diagram for RGG LED (left), spectrum for achieving 6000K white (middle) and spectrum for achieving 3200K white (right)

The RGG LED enables individual mixture of colors, as seen in the CIE 1931 diagram shown in Figure 10, including virtually every white color temperature, such as ~6000K or 3100K (see Figure 10).

Adding a yellow LED chip that closes one spectral gap will enhance the results (see Figure 11). Nevertheless, the yellow chips have very low efficiencies when compared to the red, green and blue chips.

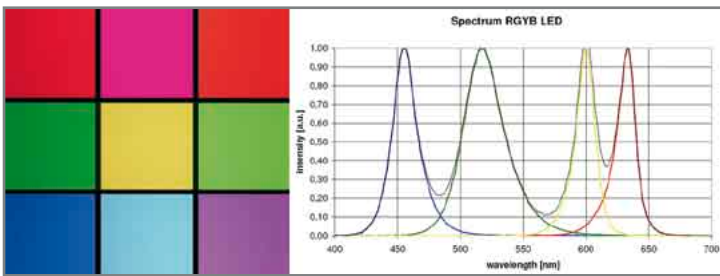

Figure 11: Color rendering and spectrum of ACULED VHL RGYB

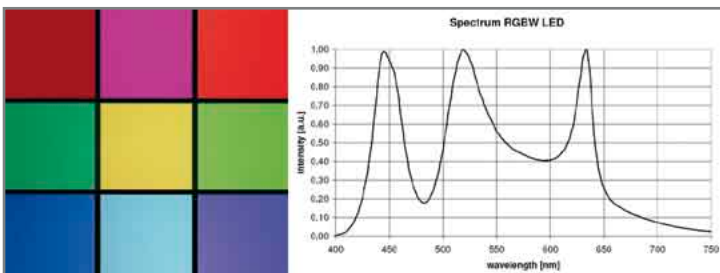

Figure 12: Color rendering and spectrum of ACULED VHL RGBW

The above results ultimately conclude that a combination of white converted LEDs with red, green and blue LEDs will achieve a highly-efficient multi-color LED, including excellent color rendering and color tunability. Figures 12 shows the spectrum and results for the illuminated color stripe with an RGB White (RGBW) - LED.

The actual LED chip generation and state-of-the-art packaging technologies make such RGBW LEDs ideal light sources for a wide variety of in both general and specialty lighting applications.

The achievable high color rendering indices of RGBW LEDs allow their use, for example, in operational lamps and add the ability to change color temperatures, if necessary. Taking an all-in-one unit with the tightest possible chip spacing will also reduce cast shadows, with or without additional optical beam shaping.

Another possible application is in entertainment lighting, particularly stage or film studio lighting. These products require excellent color rendering and the ability to change colors within a large color space - easily achievable with RGBW-LEDs.

The two examples above show the potential of high-performance, multi-color LEDs. These LEDs are poised to rapidly penetrate applications with comparable requirements due to the ever-increasing efficiency of chips and packages, as well as steadily decreasing LED costs. ■

# White Light LED Technology with Increased Efficiency and Variable CCT

> DI Erwin Baumgartner, Lumitech GmbH

The PI-LED® technology (Phosphor Innovation-LED) from LUMITECH GmbH is a white light LED module combining the advantages of RGB modules and phosphor based LED light sources. The PI-LED® module uses blue LEDs with a greenish phosphor in a high amount. This leads to a green emission with an optimized efficiency. We also demonstrate that for every type of phosphor a maximum of light output in terms of efficiency in lumens per Watt can be found. Combining such an optimized phosphor LED with both a blue and a red emitting LED allows a white light LED module with an infinitely variable correlated color temperature in the range of 2700K up to 6500K simply by controlling the intensity of the red and the blue LED. The efficiency is at least 70 lm/W over the whole range of color temperatures. The color rendering index is 90 or higher for the whole control range.

## Introduction

LED's are used since several years for the generation of white light. Main advantages are the outstanding long life time and the high efficiency. Therefore LED's are often applied if maintenance is difficult or both space and energy are limited. As LED's basically deliver monochromatic light in physically determined wavelengths there are different possibilities to achieve white light.

Widely used are trichromatic white light sources, mixing red green and blue light to white light (Figure 1 and 2). As the wavelength difference between green and red is rather large there are often used assemblies with additional LED's emitting in amber. Mostly the emission of the so called RGB (or RGBA) assemblies can be adjusted by appropriate power settings for the single emission colors. Benefits and limitations of trichromatic light sources are discussed in a multitude of publications, a more recent is given by Schubert [1].

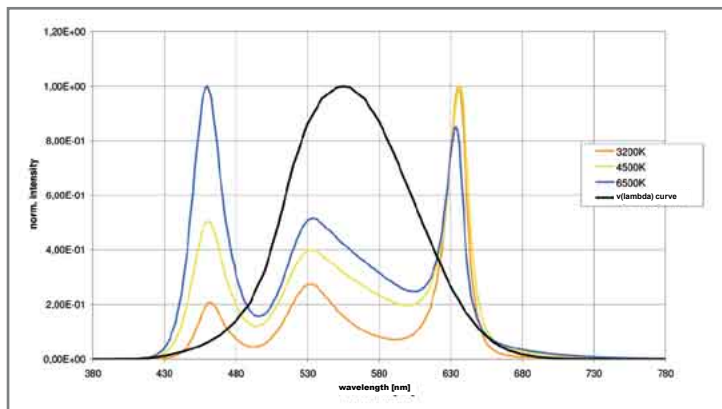

Figure 1: Emission spectra of RGB assemblies tuned to a correlated color temperature of 3200K (orange line), 4500K (yellow line) and 6500K (blue line); luminosity function  $v(\lambda)$  added for illustration

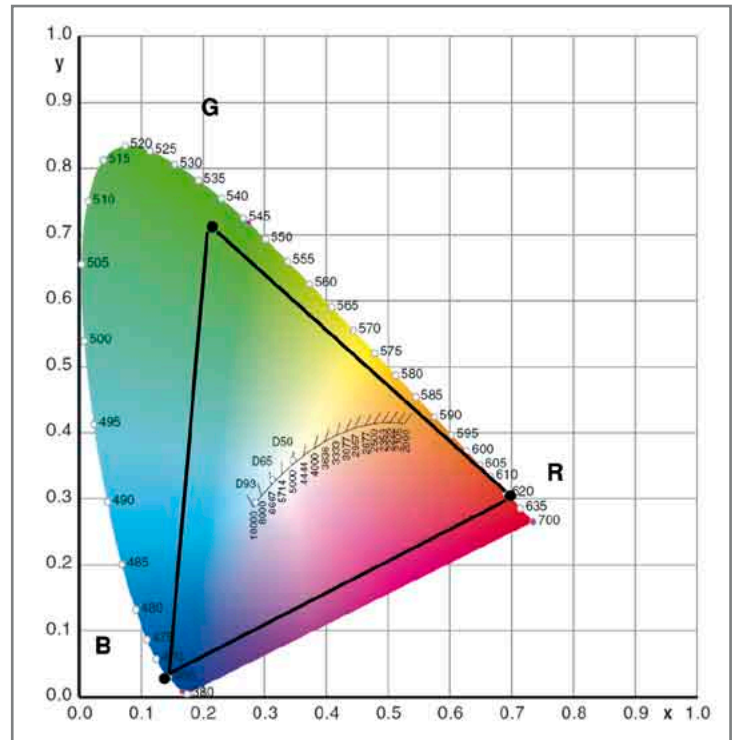

Figure 2: CIE(1931) chart of the RGB assemblies according to Figure 1

The favourable white LED is the phosphor based LED. A down conversion phosphor is pumped by a blue LED with a peak wavelength of 450 to 470 nm. There are several types of phosphors available. These materials have different chemical structures and emission spectra. Generally not all of the blue light is absorbed by the phosphor, thus leading to white light by mixing blue and yellow. For the generation of a desired correlated color temperature (in the range of 2800K to 6500K and more) especially designed phosphors or mixtures of phosphors are applied (Figure 3). The phosphor approach is discussed in a lot of papers, prevailing reviews are given by Krames et al. [2] and by Schubert and coworkers [3]. A similar construction uses UV LED's and three phosphors. But these types are not commonly used.

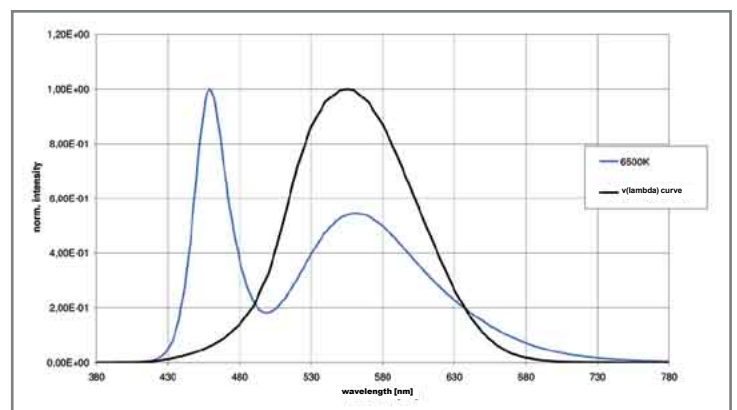

Figure 3: Emission spectrum of phosphor LED 6500K (blue line)

The described methods to make white light with LED's have benefits and disadvantages. The RGB types enable the setting of a preferred emission color or can be adjusted to any correlated color temperature. But for an use in general lighting the quality of color reproduction is not good enough as the color rendering index (CRI) is 50 or even lower. An additional limitation is the need of a sophisticated control system to compensate different temperature shifts of the LED's used.

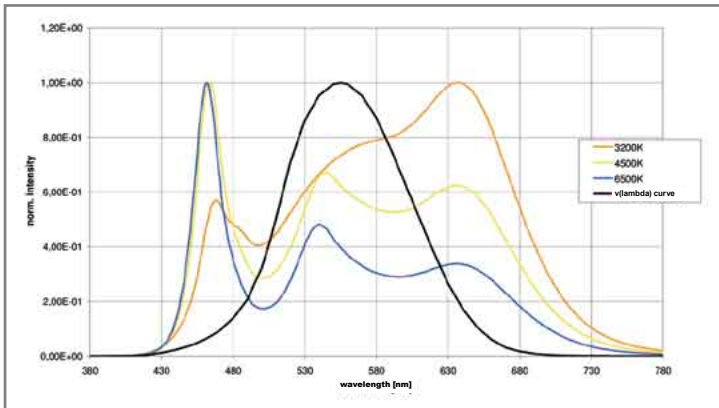

Figure 4: Spectra of hybrid module 3000K phosphor LED (orange line) plus green and blue LED's; with the appropriate power settings of green and blue LED's white light with a correlated color temperature 4500K (yellow line) and 6500K (blue line) can be achieved

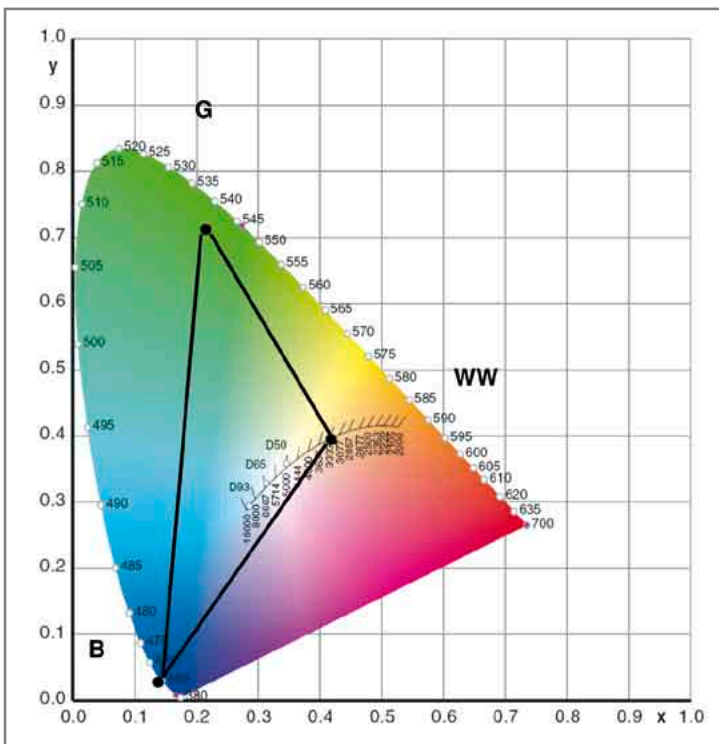

Figure 5: CIE(1931) chart of the hybrid module according to Figure 4

The phosphor based types may have a good efficiency or a good quality of the light emitted. Types with a correlated color temperature of 6500K have an efficiency of up to 60 lm/W if a state of the art chip with 300 mW radiant power at 1150 mW electrical power consumption is used. But such a white LED has an CRI of 70 or lower. If white LED's with better color rendering are needed it is possible to make the phosphor

LED with a green and an orange phosphor, correlated color temperatures down to 2800K can easily be realized. But phosphor LED's with an CRI of 90 or even higher just can be made with a poor efficiency of less than 45 lm/W.

To overcome the limitations of the above described solutions hybrid modules or assemblies can be applied. The first approach uses 3000K warm white phosphor LED and additional green and blue LED's . By the means of this a white light with high quality and good color rendering index can be made (Figure 4 and 5). If the electrical power settings for all three LED types can be tuned the correlated color temperature can be set to any value between 3000K and 6500K on the Planckian locus. The achievable efficiency is limited by the 3000K phosphor LED.

An improved construction uses a yellow phosphor LED and an additional red LED . Supposed a proper setting of the electrical power values for both LED's white light (on the Planckian locus) can be achieved. A tuning of the correlated color temperature is not possible, but an efficiency of 70 lm/W is viable with a 300 mW blue chip.

### PI-LED® technology

The PI-LED® is basically a hybrid module too. The construction is consistently determined by the two main demands for tomorrow's illuminants: A high efficiency helping to meet the requirements regarding environment protection and the ability to set the correlated color temperature to individual preference or specified requirements.

The efficiency of an LED light is basically predetermined by the efficacy of the LED chip. But it is also well known that packaging has a great impact on the total amount of light extracted. Especially in the application of phosphor a huge improvement is achieved by changing the operating point to the point of the best efficiency of the light emitted. As this point does not stringently match the black body curve for a correlated color temperature and is an especial point for each phosphor type it will be indicated by the introduction of a new, generic emission color "Phosphor".

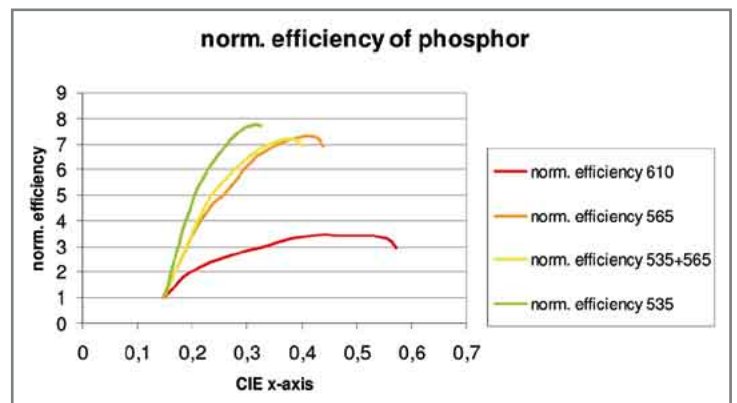

Figure 6: Standardized efficiency for some phosphors; for an easier comparison the efficiency (lm/W) of the blue LED is set to the value 1

As it is clearly demonstrated there is an optimized region for each phosphor, or mixture of phosphors. For example the phosphor indicated with "535", which is a BOSE type with a peak wavelength of 535 nm

reaches 8 times the lumens compared to the chip used for pumping this phosphor (Figure 6). The color coordinates within the CIE(1931) chart are 0.32 in x and 0.56 in y. This green-yellowish light is used for making white light by mixing it with the proper amounts of red and blue light generated by additional LED's emitting these colors.

In a second sample we used the mixture of two phosphors, both BOSE types with emission maxima at 535 nm and 565 nm respectively. The optimized working point for this mixture is 0.35 in x and 0.47 in y. A test module using four such phosphor LED's, three LED's in red and one blue LED is shown in Figure 7.



Figure 7: PI-LED module with four phosphor LED's, three red LED's and one blue LED

A big advantage over conventional constructions is the ease tuning to a desired correlated color temperature on the Planckian locus. In the CIE(1931) chart below (Figure 9) the coordinates of the LED's used in

the shown example are indicated. By adding the needed amount of red to the phosphor LED's a white light with a correlated color temperature of 2700K is achieved. By additionally mixing blue light to "Phosphor" and red any correlated color temperature on the black body curve up to 6500K can be produced.

Furthermore the PI-LED® delivers light of high quality, well suited for general lighting. Referring to the spectrum in Figure 8 the PI-LED® module has noteworthy intensity of emission over the whole visible range. This clearly explains the high color rendering index of 90 or higher over the whole range of correlated color temperature.

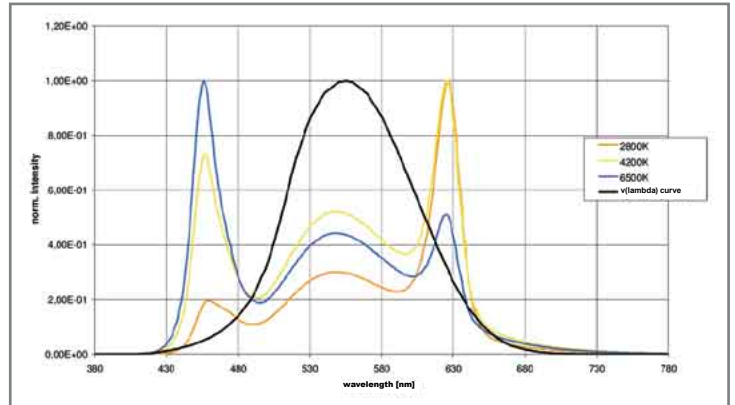

Figure 8: Spectra of PI-LED module according to Figure 7; with the appropriate power settings white light with correlated color temperatures of 2800K (orange line), 4200K (yellow line) and 6500K (blue line) can be generated

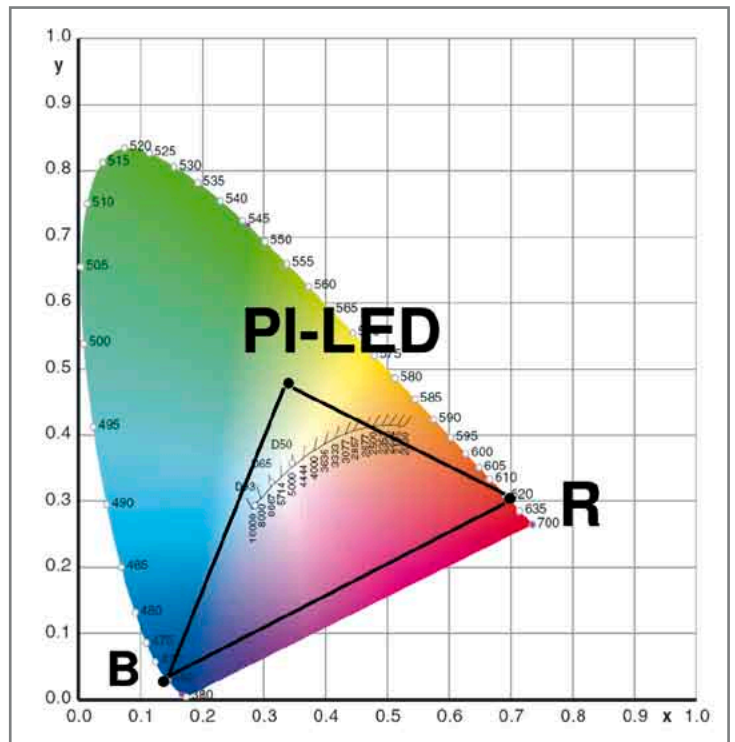

Figure 9: CIE(1931) chart of PI-LED module

The correlated color temperature is infinitely variable in the range of 2700K to 6500K. The tuning of the desired color temperature is easily done by adjusting the power of the red and blue LED's. This allows the

use of simple constructions for the electronic driving unit, as it is possible to run the phosphor LED's at constant power and just set the power for blue and red LED's with a small impact on the total lamp brightness.

The increase of efficiency, compared to phosphor LED's according the state of the art is indicated in the chart in Figure 10. At 6500K there is no real improvement as the efficiency of the standard 6500K phosphor LED is really good. On the other hand the efficacy of the blue and the red LED are too low for a distinct improvement of the over all efficiency. But for the more attractive correlated color temperature for general lighting around 3000K there is a remarkable increase of 30% compared

to a standard phosphor LED. The rise of the efficiency is mainly influenced by the emission color "Phosphor" as the luminosity function (V) of the human eye is taken into account for choosing the right phosphor (or mixture).

A compensation for different temperature shifts of the LED chips is not really required as the deviation from the black body curve caused by different ambient temperatures or varying self heating caused by the adjustable power is rather small. The formerly discussed sample has in the low power level a CCT of 6528K (x=0,3131 / y=0,3221) and in high power operation 6706 (x=0,3104 / y=0,3212) respectively.

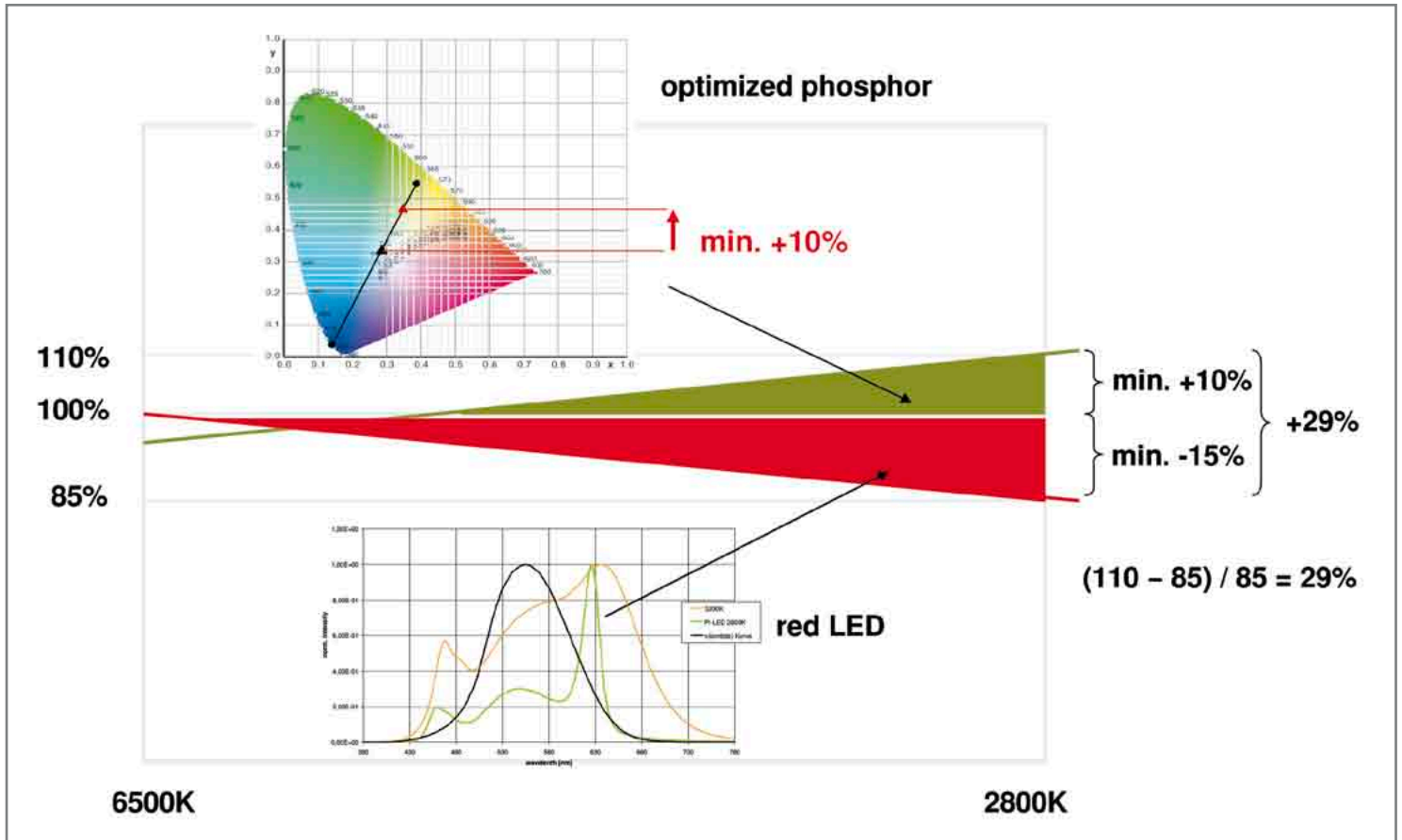

Figure 10: Highest efficiency by using the combination of optimized phosphor technology and red LED's

## Conclusions and outlook

The PI-LED® is designed to meet the main advantages of the LED technology. With today's efficiency of the LED chips white LED's actually reach the performance of fluorescent lamps. But the technology has still a high potential to improve the efficacy. The packaging can be optimized too. Therefore white LED's will be the illuminant with the best efficiency, helping to reduce environmental pollution.

The ability to tune to any preferred correlated color temperature on the black body curve in the range of 2700K to 6500K is not possible with conventional light sources such as incandescent or fluorescent lamps. Especially this highly desirable feature of the infinitely variable correlated color temperature will facilitate the market penetration of white LED's for general lighting. ■

### References:

- [1] S. Chhajed, Y. Xi, Y. Li, Th. Gessmann and E. F. Schubert, *J. appl. Phys.*, 97, 054506 (2005)
- [2] M. R. Krames, O. B. Shchekin, R. Mueller-Mach, G.O. Mueller, L. Zhou, G. Harbers and M.G. Craford, *J. Disp. Techn.*, 3, 160 (2007)
- [3] E.F. Schubert, J. K. Kim, H. Luo and J.-Q. Xi, *Rep. Prog. Phys.*, 69, 3069 (2006)
- [4] I. Speier and M. Salsbury, *Proceedings of SPIE, Sixth International Conference on Solid State Lighting*, 6337, 63371F (2006)
- [5] A. van de Ven and G. Negley, *Proceedings of First International Conference on white LEDs and Solid State Lighting*, 153 (2007)

# LED Binning: A Process to Watch

> Joe Mazzone, Lamina

## Introduction

The race is on to move LEDs to the forefront of general illumination. Before 2006, solid state LED lighting had not been used for general illumination because of a lack of intensity. But today, solid state LED lamps are increasingly used to replace incandescent lamps in commercial, industrial and residential applications. This movement is gaining momentum because solid state light sources generally last 50-10 times longer than incandescent lamps, consume about 25% of the energy, can operate at lower temperatures with lower risk of fire, and are more rugged than common incandescent and fluorescent lamps. What's more, LEDs can be produced which deliver light up to the equivalent of 175W incandescent bulbs, with energy efficiency equal to that of fluorescents. The use of proprietary packaging systems which manage thermal energy now allows those intensities to be achieved, and along with them the ability to illuminate entire rooms with LEDs.

Along the way, more lighting professionals are getting acquainted with a process used in the manufacture of LED light engines called binning. Just what is binning and why is it relevant? This article hopes to answer both questions as LEDs gain more prominence for use in general lighting.

## Definition

Binning can generally be defined as the process used by manufacturers fabricating with semiconductor materials, to account for inherent inconsistencies in characteristics. Binning is used by the manufacturers themselves when purchasing LED wafers, or die, that meet the manufacturer's own stringent performance standards for electrical, thermal, efficiency and optical characteristics. The careful review of all of these criteria determines which die the manufacturer will incorporate into each lighting system they produce. Binning by luminous intensity may be requested when the end product is to be used as a radiant emitter; sorting by forward voltage will guarantee similar current for parallel strings.

For those manufacturers whose end product is an LED light engine, emitter module, or lamp, there is another binning process introduced by them when finalizing their own production. Since optics, phosphor coatings and other processes and components added to the original LED die can change output characteristics, for even one single production batch or part number, LEDs can represent a wide spread in terms of certain parameters.

Binning allows manufacturers to sort the LEDs according to their differing criteria, which can include:

- Dominant wavelength
- Peak wavelength
- Color Rendering Index (CRI)
- Forward voltage
- Economical use of all die or devices in a bin
- Uniform light output (TLF)
- Color uniformity, and
- White light CRI, TLF, and Correlated Color Temperature (CCT)

The difference of a single dominant wavelength bin can be noticeable to the human eye. Lighting designers with specific requirements in their LEDs as a component of their lighting systems can specify a binning code or binning number. This ensures that the LEDs delivered to them perform with the same characteristics consistently, from light engine to light engine.

Binning occurs after the LED wafer processing is complete and usually before it is diced. The first step in binning is to electrically and optically probe each die on the wafer. Automated equipment is available for this process. A table database is then constructed that includes all of the measured parameters for each die. After probing, the wafer is diced and each die is automatically segregated according to the above binning criteria. Bin combinations are possible, for example forward voltage and intensity, or intensity and peak wavelength.

The wafer is normally maintained at a constant temperature (25° C) during the binning process. Parameter performance at a different temperature can be determined by creating a curve relating parameter change (if any) with temperature.

## Manufacturer binning varies

Binning practices vary from manufacturer to manufacturer. Some manufacturers let their customers specify a range bin value from which they can receive their order. Others do not. Some have created intricate labeling mechanisms and tables with which to identify units for color, flux and forward voltage; the end-user must then calculate if the units are to be used in multiples, or an array. Some promise ever "tighter" binning and sub-binning practices, sorting units into increasingly finer characteristic increments.

As LEDs move to more use in general lighting categories and applications, the designer's awareness of the variances in capabilities between products from one bin to another is sure to become more pronounced. On the bright side, the myriad variations represented by binning mean the choices with which to create a wide variety of subtle lighting effects are wider and more interesting than ever.

## Making jewelry sparkle

Lighting designers may require the LED to deliver a very specific point in the color range, for example. In order to make the jewelry in their cabinets sparkle to its utmost brilliance, lighting designers for Cartier, the renowned French jeweler and watchmaker, request not just the



Lamina SÖL™ MR16 LED, but the Lamina SÖL MR16 LED with a very particular binning number, because it creates the correct color of white light (which can vary widely) to show the jewelry most beautifully. Cartier has even gone so far as to enter the binning number into the company's construction specification charter covering cabinetry built for all new Cartier shops worldwide.

## Making binning changes

Others in the lighting community, however, want fewer choices in LEDs, and more simplicity in making those choices. They call on the LED manufacturers to develop new technologies that reduce the variation in LED light output, so there can be more consistency from luminaire to luminaire, and to continue to improve LED power output.

Some manufacturers are developing new technology relating to the use of phosphors to produce a high number of units in the most desired color temperatures. Others are using digitally controlled equipment to provide color compensation between units. Still others are utilizing references to the MacAdam index of color difference implemented worldwide by fluorescent manufacturers. Some are experimenting with white photo conversion technology to eliminate binning and offer a single chromatic range.

## Binning gets creative

Lamina is using binning to enhance the performance characteristics of its products. The company's products consist of diode arrays; those products containing the least amount of LEDs have four, those containing the most may have as many as 40. When the arrays are built, an entire production of LED die is assessed for its attributes, and then an algorithm is developed for selection to produce the combined performance out of the end product. This practice leads to economical efficiencies, since more die from a single production run are utilized and fewer are discarded for undesirable characteristics.

Binning in this manner also allows the end products to deliver, for example, enhanced color rendering since the arrays combine multiple die representing a wide span of CCT, and those die have been combined using highly selective techniques. For example, a common way to create white light with an LED is to use a blue or ultraviolet light source coated with a yellow phosphor. This results in some blue light passing through, and some of it being absorbed to combine with the yellow to create white light. An inherent problem in this practice, however, when using single LEDs is that the white color and color quality suffers in the process. Lamina's solution involves using several blue die of slightly differing wavelengths together in a highly compact array. Some or all of the dice in the array are coated with the yellow phosphor, to produce a spectrum of emission patterns depending on the particular blue that is utilized, thereby broadening the color rendering the emitter will deliver (Binning examples see Figure 1 and 2).

### Biography:

Joe Mazzochette is Vice President of Engineering for Lamina Lighting. He leads a team of industry-seasoned engineering personnel dedicated to designing and building long-lasting, super-bright LED light engines to exacting specifications.

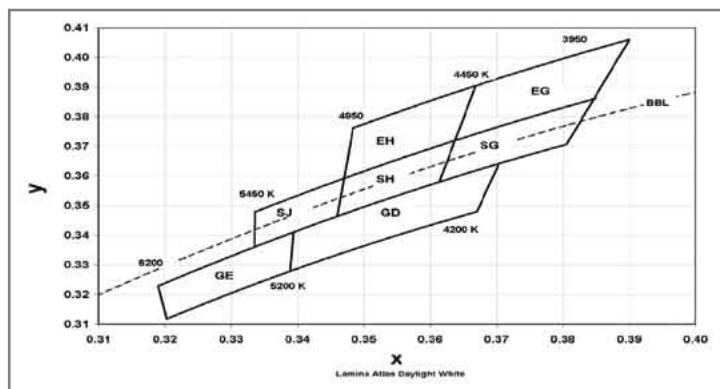

Figure 1: Cold White LED binning

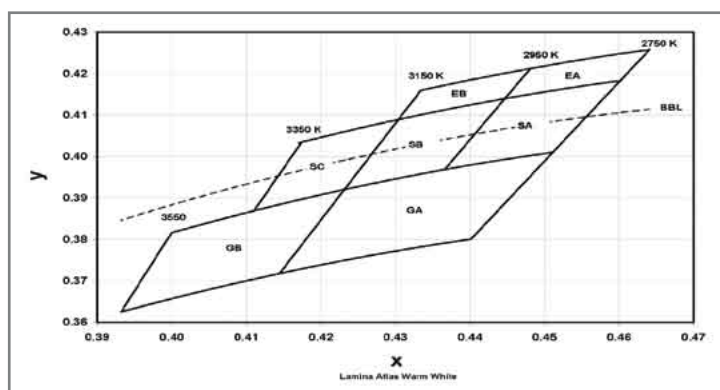

Figure 2: Warm White LED binning

Binning in this manner for dominant wavelength utilizes similar techniques. For example, a large shipment of diodes represents a wide variation of wavelengths for green. An algorithm is used to select the die – an appropriate sampling of the range of wavelength variation – and they are then combined in an array to produce a very tight dominant wavelength that is very consistent from unit to unit. Customers enjoy not only consistency in desired product attributes but also cost efficiencies associated with the ability to utilize all dice from a large shipment.

## Binning for the future

As LEDs make headway into use in the general lighting scheme, the process of binning will be one to watch. Will it go away entirely? Will it become a more important part of the LED manufacturing realm? An educated guess would be, probably a little of both.

Use of LEDs for mass, generalized applications will call for manufacturing techniques that can produce consistency of product in highly efficient ways that may not include binning. But, as lighting designers learn more about the type of performance LEDs can deliver, and their use is tested by fresh and innovative design concepts, binning could take on greater importance as a way to create very specific LED performance characteristics for new and unexpected uses. ■

# DEX 2008 The 16th DEX Electronic Exhibition

多人行电子展 2008 International Photonics & Display (China) Exhibition

Approved by : Ministry of Science & Technology of PRC.

Special exhibition Hall: 1、 Optics; 2、 LED semiconductor illumination ; 3、 LCD panel display

**PERIOD:** from June 19th to 21st, 2008

**VENUE:** Shenzhen Convention & Exhibition Center, China



**SPONSORS:**

Chinese Institute of Electronics (CIE)  
Shenzhen Association of the Optics & Optoelectronic  
Shenzhen E-Dowell Industrial Co., Ltd.

**ORGANIZERS:**

Shenzhen E-Dowell Industrial Co., Ltd.

[e99999.com](http://e99999.com)  
多人行电子网

**Synchronization:**

2008 International Electronic Equipments and Components (China) Exhibition

**Welcome to E-Dowell electronic exchange website: [www.e99999.com](http://www.e99999.com)**

- ★ If you take part in our 2008 exhibition, you can get a large-scale data type dynamic exchange Website service for free in E-dowell electronic exchange website and you can use it for free until may of 2009.
- ★ One of the most professional Photonics & Display Exhibition in China (The total exhibition area is up to 80,000 square meters).
- ★ DEX Electronic Exhibition was awarded the prize of "the Best Representative of 25-year Development in Shenzhen City" in Nov. Of 2005.

Organizing : Shenzhen E-Dowell Industry Co., Ltd Contact Person: Ms. Jin Ms. Zhang Shenzhen Office: +86-755-83502448, 83502441 HongKong Office: 00852-23419810 E-mail: dex@e99999.com

Visitors Admission for free based on Ticket and Name Card.



## 2008 The 16th DEX Electronic Exhibition

2008 International Photonics & Display (China) Exhibition

Approved by : Ministry of Science & Technology of PRC.



**PERIOD:** from June 19th to 21st, 2008  
**VENUE:** Shenzhen Convention & Exhibition Center, China

**Special exhibition Hall:**

◇ LED ◇ LCD ◇ Optics

**One of the most professional Photonics & Display Exhibition in China**

Synchronization: 2008 International Electronic Equipments and Components (China) Exhibition

# TICKET

Welcome to E-Dowell electronic exchange website:

[e99999.com](http://e99999.com)  
多人行电子网

Organizing : Shenzhen E-Dowell Industry Co., Ltd Contact Person: Ms. Jin Ms. Zhang Shenzhen Office: +86-755-83502448, 83502441 HongKong Office: 00852-23419810 E-mail: dex@e99999.com

# Methodology

## TRIZ Introduction

> Siegfried Luger, LED professional

TRIZ, (pronounced [tri:z]), is a Russian acronym for "Teoriya Resheniya Izobretatelskikh Zadatch" (Теория решения изобретательских задач), a Theory of solving inventive problems or Theory of inventive problems solving (TIPS) (less known as Theory of Solving Inventors' Problems), developed by Genrich Altshuller and his colleagues since 1946.

TRIZ is a methodology, tool set, knowledge base, and model-based technology for generating innovative ideas and solutions for problem solving. TRIZ provides tools and methods for use in problem formulation, system analysis, failure analysis, and patterns of system evolution. TRIZ, in contrast to techniques such as brainstorming (which is based on random idea generation), aims to create an algorithmic approach to the invention of new systems, and the refinement of old systems.

### History

Altshuller began to develop TRIZ methodology while working in USSR patent office. He and his colleagues reviewed over 200,000 patent abstracts in order to find out in what way the innovation had taken place. Incarcerated under political charges, he continued his work on TRIZ while in the Gulag labor camps. He eventually developed 40 Principles of Invention, several Laws of the Evolution of Technical Systems (Laws of Technical Systems Evolution), the concepts of technical and physical contradictions that creative inventions resolve, the concept of Ideality of a system and numerous other theoretical and practical approaches; together, this extensive work represents a unique contribution to the development of creativity and inventive problem-solving.

The tools developed under Altshuller's leadership were: 40 Principles 1946-1971, ARIZ 1959-1985, Separation Principles 1946-1985, Substance-Field Analysis (Su-Field Analysis) 1973-1981, Standard Solutions 1977-1985, Natural Effects (Scientific Effects) 1970-1980, Patterns of Evolution 1975-1980. The different schools for TRIZ and individual practitioners have continued to improve and add to the methodology.

### TRIZ essentials

#### Identifying a problem: contradictions

Altshuller believed that inventive problems stem from contradictions (one of the basic TRIZ concepts) or tradeoffs between two or more elements, such as "If we want more acceleration, we need a larger engine - but that will increase the cost of the car". That is, more of something desirable also brings more of something else undesirable, or less of something else also desirable. These are called Technical Contradictions by Altshuller. He also defined so-called Physical or

inherent contradictions: we may need at the same time more and less of something. For instance, we may need higher temperature in order to melt a compound more rapidly, but less temperature in order to achieve a homogeneous mixture.

An inventive situation might involve several such contradictions. The inventor typically does not resolve a contradiction by stepping in the middle of the tradeoff - for that, no special inventivity is needed. Rather, he develops some creative approach for dissolving the contradiction: for instance, he would invent an engine that does produce more acceleration without increasing the cost of the engine.

### Inventive principles and the matrix of contradictions

Genrich S. Altshuller screened patents in order to find out what kind of contradictions were resolved or dissolved by the invention and the way this had been achieved. From this, he developed a set of 40 inventive principles and later a "Matrix of Contradictions". Rows of the matrix indicate the "39 system parameters" that one typically wants to improve, such as speed, weight, accuracy of measurement and so on. Columns refer to typical undesired results. Each matrix cell points to principles that have been most frequently used in patents in order to resolve the contradiction.

### Laws of technical system evolution

Altshuller also studied the way technical systems have been developed and improved over time. From this, he discovered several trends ( so called Laws of Technical Systems Evolution) that help engineers to predict what are the most likely improvements that can be made to a given product. The most important of these laws involves the ideality of a system (another basic TRIZ concept).

### Substance-field analysis

One more technique that is frequently used by inventors involves the analysis of substances, fields and other resources that are currently not being used and that can be found within the system or nearby. Note, that TRIZ uses non-standard definition for substances and fields. G.S. Altshuller developed methods to analyze resources; several of his invention principles involve the use of different substances and fields that help resolve contradictions and increase ideality of a technical system.

### ARIZ - algorithm of inventive problems solving

ARIZ (russ. acronym of Алгоритм решения изобретательских задач) - Algorithm of Inventive Problems Solving is a list of (about 85) step-by-step procedures to solve very complicated invention problems, where other tools of TRIZ (Su-field analysis, 40 inventive principles, etc.) are not applicable directly.

## 40 inventive Principles

### Principle 1. Segmentation

1. Divide an object into independent parts.
2. Make an object easy to disassemble.
3. Increase the degree of fragmentation or segmentation.

### Principle 2. Taking out

1. Separate an interfering part or property from an object, or single out the only necessary part (or property) of an object.

### Principle 3. Local quality

1. Change an object's structure from uniform to non-uniform, change an external environment (or external influence) from uniform to non-uniform.
2. Make each part of an object function in conditions most suitable for its operation.
3. Make each part of an object fulfill a different and useful function.

### Principle 4. Asymmetry

1. A. Change the shape of an object from symmetrical to asymmetrical.
2. If an object is asymmetrical, increase its degree of asymmetry.

### Principle 5. Merging

1. Bring closer together (or merge) identical or similar objects, assemble identical or similar parts to perform parallel operations.
2. Make operations contiguous or parallel; bring them together in time.

### Principle 6. Universality

1. Make a part or object perform multiple functions; eliminate the need for other parts.

### Principle 7. "Nested doll"

1. Place one object inside another; place each object, in turn, inside the other.
2. Make one part pass through a cavity in the other.

### Principle 8. Anti-weight

1. To compensate for the weight of an object, merge it with other objects that provide lift.
2. To compensate for the weight of an object, make it interact with the environment (e.g. use aerodynamic, hydrodynamic, buoyancy and other forces).

### Principle 9. Preliminary anti-action

1. If it will be necessary to do an action with both harmful and useful effects, this action should be replaced with anti-actions to control harmful effects.
2. Create beforehand stresses in an object that will oppose known undesirable working stresses later on.

### Principle 10. Preliminary action

1. Perform, before it is needed, the required change of an object (either fully or partially).
2. Pre-arrange objects such that they can come into action from the most convenient place and without losing time for their delivery.

### Principle 11. Beforehand cushioning

1. Prepare emergency means beforehand to compensate for the relatively low reliability of an object.

### Principle 12. Equipotentiality

1. In a potential field, limit position changes (e.g. change operating conditions to eliminate the need to raise or lower objects in a gravity field).

### Principle 13. 'The other way round'

1. Invert the action(s) used to solve the problem (e.g. instead of cooling an object, heat it).
2. Make movable parts (or the external environment) fixed, and fixed parts movable).
3. Turn the object (or process) 'upside down'.

### Principle 14. Spheroidality – Curvature

1. Instead of using rectilinear parts, surfaces, or forms, use curvilinear ones; move from flat surfaces to spherical ones; from parts shaped as a cube (parallelepiped) to ball-shaped structures.
2. Use rollers, balls, spirals, domes.
3. Go from linear to rotary motion, use centrifugal forces.

### Principle 15. Dynamics

1. Allow (or design) the characteristics of an object, external environment, or process to change to be optimal or to find an optimal operating condition.
2. Divide an object into parts capable of movement relative to each other.
3. If an object (or process) is rigid or inflexible, make it movable or adaptive.

### Principle 16. Partial or excessive actions

1. If 100 percent of an object is hard to achieve using a given solution method then, by using 'slightly less' or 'slightly more' of the same method, the problem may be considerably easier to solve.

### Principle 17. Another dimension

1. To move an object in two- or three-dimensional space.
2. Use a multi-story arrangement of objects instead of a single-story arrangement.
3. Tilt or re-orient the object, lay it on its side.
4. Use 'another side' of a given area.

### Principle 18. Mechanical vibration

1. Cause an object to oscillate or vibrate.
2. Increase its frequency (even up to the ultrasonic).
3. Use an object's resonant frequency.
4. Use piezoelectric vibrators instead of mechanical ones.
5. Use combined ultrasonic and electromagnetic field oscillations.

### Principle 19. Periodic action

1. Instead of continuous action, use periodic or pulsating actions.
2. If an action is already periodic, change the periodic magnitude or frequency.
3. Use pauses between impulses to perform a different action.

**Principle 20. Continuity of useful action**

1. Carry on work continuously; make all parts of an object work at full load, all the time.
2. Eliminate all idle or intermittent actions or work.

**Principle 21. Skipping**

1. Conduct a process, or certain stages (e.g. destructible, harmful or hazardous operations) at high speed.

**Principle 22. "Blessing in disguise"**

1. Use harmful factors (particularly, harmful effects of the environment or surroundings) to achieve a positive effect.
2. Eliminate the primary harmful action by adding it to another harmful action to resolve the problem.
3. Amplify a harmful factor to such a degree that it is no longer harmful.

**Principle 23. Feedback**

1. Introduce feedback (referring back, cross-checking) to improve a process or action.
2. If feedback is already used, change its magnitude or influence.

**Principle 24. 'Intermediary'**

1. Use an intermediary carrier article or intermediary process.
2. Merge one object temporarily with another (which can be easily removed).

**Principle 25. Self-service**

1. Make an object serve itself by performing auxiliary helpful functions
2. Use waste resources, energy, or substances.

**Principle 26. Copying**

1. Instead of an unavailable, expensive, fragile object, use simpler and inexpensive copies.
2. Replace an object, or process with optical copies.
3. If visible optical copies are already used, move to infrared or ultraviolet copies.

**Principle 27. Cheap short-living objects**

1. Replace an inexpensive object with a multiple of inexpensive objects, comprising certain qualities (such as service life, for instance).

**Principle 28 Mechanics substitution**

1. Replace a mechanical means with a sensory (optical, acoustic, taste or smell) means.
2. Use electric, magnetic and electromagnetic fields to interact with the object.
3. Change from static to movable fields, from unstructured fields to those having structure.
4. Use fields in conjunction with field-activated (e.g. ferromagnetic) particles.

**Principle 29. Pneumatics and hydraulics**

1. Use gas and liquid parts of an object instead of solid parts (e.g. inflatable, filled with liquids, air cushion, hydrostatic, hydro-reactive).

**Principle 30. Flexible shells and thin films**

1. Use flexible shells and thin films instead of three dimensional structures
2. Isolate the object from the external environment using flexible shells and thin films.

**Principle 31. Porous materials**

1. Make an object porous or add porous elements (inserts, coatings, etc.).
2. If an object is already porous, use the pores to introduce a useful substance or function.

**Principle 32. Color changes**

1. Change the color of an object or its external environment.
2. Change the transparency of an object or its external environment.

**Principle 33. Homogeneity**

1. Make objects interacting with a given object of the same material (or material with identical properties).

**Principle 34. Discarding and recovering**

1. Make portions of an object that have fulfilled their functions go away (discard by dissolving, evaporating, etc.) or modify these directly during operation.
2. Conversely, restore consumable parts of an object directly in operation.

**Principle 35. Parameter changes**

1. Change an object's physical state (e.g. to a gas, liquid, or solid).
2. Change the concentration or consistency.
3. Change the degree of flexibility.
4. Change the temperature.

**Principle 36. Phase transitions**

1. Use phenomena occurring during phase transitions (e.g. volume changes, loss or absorption of heat, etc.).

**Principle 37. Thermal expansion**

1. Use thermal expansion (or contraction) of materials.
2. If thermal expansion is being used, use multiple materials with different coefficients of thermal expansion.

**Principle 38. Strong oxidants**

1. Replace common air with oxygen-enriched air.
2. Replace enriched air with pure oxygen.
3. Expose air or oxygen to ionizing radiation.
4. Use ionized oxygen.
5. Replace ozonized (or ionized) oxygen with ozone.

**Principle 39. Inert atmosphere**

1. Replace a normal environment with an inert one.
2. Add neutral parts, or inert additives to an object.

**Principle 40. Composite materials**

1. Change from uniform to composite (multiple) materials.

You may also download the Altshuller Matrix as an EXCEL file from [http://www.lugerresearch.com/Altshuller\\_Matrix.xls](http://www.lugerresearch.com/Altshuller_Matrix.xls). ■

## Light & Building in Frankfurt (April 6<sup>th</sup>-11<sup>th</sup> , 2008)

Dear LED professional Review (LpR) Readers and Advertisers,

in April the Light & Building, one of the biggest Lighting exhibitions worldwide, will take place in Frankfurt.

For this event we're going to publish a special LpR issue which will be distributed to a broad audience within the Lighting Industry.

Technologies covered: *LEDs, OLEDs, Optics, Phosphors, Driver ICs, LED Modules, Driver Modules, Supplies, Thermal Management Systems, LED Lighting and Control Systems, and measuring/production equipment.*

Either you can send us your press-release or, you may order a guaranteed Ad space until March 7, 2008.

Please send your enquiry to: [editors@led-professional.com](mailto:editors@led-professional.com)

We're looking forward to hearing from you.

Yours Sincerely,

LED professional Team

### **Publisher**

Luger Research  
Institute for Innovation & Technology  
dep LED professional  
Rhombergs Fabrik  
A 6850 Dornbirn, Austria | Europe  
phone +43 5572 394 489  
fax +43 5572 394 698  
[editors@led-professional.com](mailto:editors@led-professional.com)

# LEA 2008 LIGHTING Taiwan

## Lighting Up Your Future !

June 11~13, 2008

Taipei World Trade Center

## LED Lighting Taiwan 2008

- The 4th International LED Lighting Exposition



### Exhibits

#### ■ LED Lighting Fixture

Indoor, Outdoor, Specialty  
Decorating, Landscape, Architecture, Garden  
Control System & Accessories

#### ■ LED Applications

Automotive Lamps, Backlight, Display Board,  
Traffic Signal, IrDA, etc.

#### ■ Package / Module

Lamp, Dot Matrix, Cluster, SMD, etc

#### ■ Epi Wafer, Chip

#### ■ Materials

Substrate, Ingot, Phosphor,  
Lead Frame, etc.

#### ■ Processing Equipment

Wafer (MOCVD, Mask, Etching)  
Assembly (Dicing, Bonding, Packaging)  
Testing (Prober, Aging)

Organizer :



**Photonics Industry & Technology Development Association**

Overseas contact : Pamela Hsiao

E-mail : [exhibit@mail.pida.org.tw](mailto:exhibit@mail.pida.org.tw)

Tel : +886-2-2351-4026 ext. 805 Fax : +886-2-2396-8513

Show websites : <http://www.optotaiwan.com>

### Concurrent Expositions

#### Photonics Festival in Taiwan

**OPTO Taiwan 2008** The 17th Int'l Opto-electronics Exposition

**OPTICS Taiwan 2008** The 2nd Int'l Precision Optics Exposition

**SOLAR Taiwan 2008** The 2nd Int'l Solar Exposition

#### Display Taiwan 2008

The 10th Int'l Flat Panel Display Exposition

# LED colour mixing for maximum attraction.

[www.tridonicatco.com](http://www.tridonicatco.com)



TALEXchain D511 TALEXcontrol K211

A wonderful attraction is the 50 m<sup>2</sup> glass wall which shines out in ever changing colours from the Café Bar area at the Seerestaurant Rorschach. **TALEX**chain D511 from TridonicAtco have such compact dimensions that they can be used in depths of just 150 mm to provide absolutely uniform illumination of the glass cover. And with such a long LED life, the units are virtually maintenance-free. What's more, the D511 RGB chains – operated on electronic converters and three-channel LED C004 PWM amplifiers – reduce operating costs thanks to their energy efficiency and low heat output. It all makes this seafood restaurant shine out alluringly in the dark night.

a world of bright ideas®

TRIDONIC.ATCO



Seerestaurant Rorschach, Switzerland