

Thermal Management

Degradation of White LEDs
Thermally Conductive Plastics
Advanced Thermal Management Materials

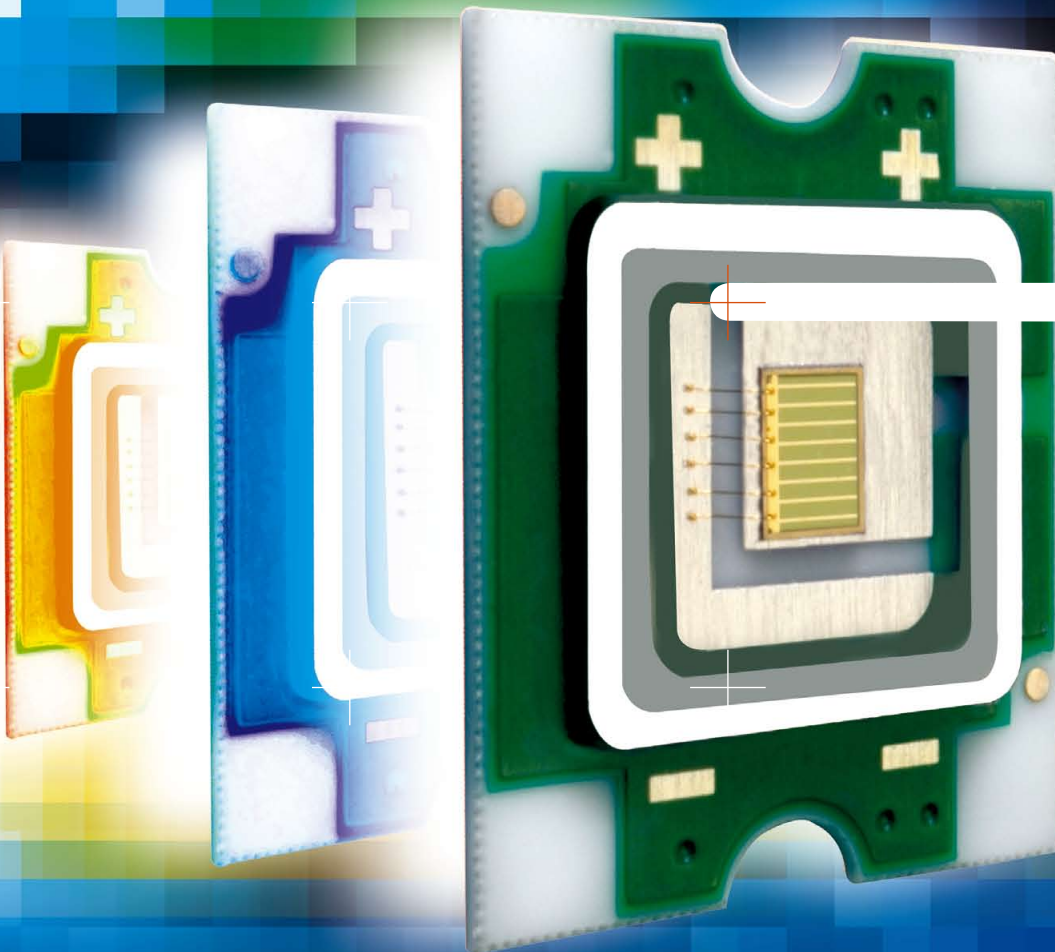

Sharp LED solutions for bright sparks

LED's work together!



[IC]

[OPTO]

[LED]

[LCD]

[RF]

Go for the broad range of Sharp LED solutions to present your applications in the best possible light: LED multi-chip modules, white light LEDs, RGB LEDs and flashlight LEDs. Whether single spotlight or wide-area ambient lighting, indoor or outdoor, stationary or mobile usage, Sharp LEDs combine maximum efficiency and lifetime with minimal heat generation. You can define white in the most beautiful tones – anything from warm to cold white and high CRI optimised for almost natural colour reproducibility. The Sharp portfolio offers a wide variety of different

packages: from PLCC2 to PLCC6, standard or extra thin, sideshoot and ultra-small – and features LEDs for work and reading lamps, indoor and outdoor lighting, signalling equipment and advertising panels, flash-lights and displays as well as architectural and medical applications. Call or mail us to benefit from 37 years of experience in LED technology.

Our Service Team will be glad to supply you with any engineering samples and advice you need.

E-Mail: info.sme@sharp.eu; phone: +49 (0)180 507 35 07

light+building

Visit us at the Light+Building 2010
from 11-16 April in Frankfurt am Main: Hall 4.2, Booth J71.

SHARP

| Microelectronics

Bright Future for LEDs – HB-LEDs Top



What do the upcoming years for the global LED market look like? The move by LEDs into general illumination applications, with the availability of LED lights for replacing conventional light bulbs, directed the LED market growth last year. It is obvious that a lot of further lighting applications show a rising penetration of LEDs including spot-lights, downlights, automotive lighting, traffic and street lighting, backlighting of large-sized LEDs in televisions, notebooks and computer monitors. But what does it mean in terms of volume?

The global LED revenue expanded by about 10% in 2009 and reached USD 7.4 billion, up from USD 6.7 billion in 2008. By 2013, the global LED market will reach USD 14.3 billion, says Dr. Jagdish Rebello director and principal analyst at iSuppli, nearly double (193%) from last year. He continued to say that: "The LED industry is on the threshold of a new expansion phase - a phase that will be characterized by growth rates in the high double digits during the next three years. This growth will be driven by the increased adoption of High Brightness (HB) and high flux - also referred to as high power or Ultra High brightness (UHB) - LEDs into a new range of next-generation lighting applications."

As expected, the solid-state lighting market for HB and high-flux devices will outpace overall LED market growth through the year 2013. Through 2013, revenue generated by the traditional market for standard-brightness LEDs will decline by about 2.5%, while the market for HB LEDs will grow by 6.7% to approximately USD 5.4 billion. According to ElectroniCast Consultants the global consumption value of HB-LEDs in 2009 was nearly USD 4.9 billion, about two-thirds of the total global LED revenue. The consumption value is forecasted to increase to USD 15 billion in 2015.

The LED market demand forecasts correspond with the outlook done for LED production equipment.

Sell-side analysts forecast a doubling in MOCVD (MetalOrganic Vapour Phase Epitaxy Deposition) tool demand, from 208 tools in 2009 to 415 tools in 2011, representing a market greater than USD 1 billion based on an average selling price of USD 2.5 million for each MOCVD tool. MOCVD represents 8% of the typical cost breakdown for a packaged LED.

All-in-all the data from the analysts shows a bright future for the LEDs and especially the HB LED devices and its applications. We will also support you this year with leading-edge technology information on all relevant aspects in LED lighting, which is key for participating in this strong growing market.

We would be delighted to receive your feedback about *LpR*. Let us know what you like or tell us how we can improve our services. You are also welcome to contribute your own editorials.

Yours Sincerely,

A handwritten signature in blue ink, appearing to read 'S. Luger'.

Siegfried Luger

Publisher

Imprint

LED professional Review (LpR)

ISSN 1993-890X

Publisher

Luger Research e.U.
Institute for Innovation & Technology
dep LED professional
Faerbergasse 15, Haus Rot
A 6850 Dornbirn, Austria / Europe
phone +43 5572 394 489
fax +43 5572 394 489 90
editors@led-professional.com
www.led-professional.com

Publishing Editors

Siegfried Luger
Arno Grabher-Meyer

Account Manager

Theresa Koenig

Promotion Manager

Silvia Girardelli

Front-page picture

Luminus Devices: PhlatLight LED, SBT series
Artwork: Thomas Klobassa, ©LED professional 2010

Copyrights – Luger Research e.U.

The editors make every reasonable effort to verify the information published, but Luger Research e.U. assumes no responsibility for the validity of any manufacturers, non profit organisations or individuals claims or statements. Luger Research e.U. does not assume and hereby disclaims any liability to any person for any loss or damage caused by errors or omissions in the material contained herein, regardless of whether such errors result from negligence, accident or any other cause whatsoever. You may not copy, reproduce, republish, download, post, broadcast, transmit, make available to the public, or otherwise use of *LED professional Review (LpR)* content without the prior written permission from Luger Research e.U. – Institute for Innovation & Technology, Austria. ■



LED professional Review (LpR) – Annual Subscriptions

LpR Digital Magazine

- 6 issues
- pdf download
- high resolution pictures and graphs
- printable
- commercial use
- access to all previous issues
- Euro 78.80
- <http://www.led-professional.com/subscription>

LpR Printed Magazine

- 6 issues
- Euro 158.40

Next LpR Issue – Mar/Apr 2010

- LED Applications & Lighting Systems

Content

Editorial	p1
Imprint	p2
Project News	p5
Product News	p5
Event News	p16

■ Event Reports

LED FORUM MOSCOW 2009 & INTERLIGHT MOSCOW by A. Grabher-Meyer, LED professional	p18
---	-----

■ Thermal Management

Thermally Activated Degradation of Phosphor-Converted White LEDs by L. Trevisanello, M. Meneghini, Dept. of Information Engineering, University of Padova	p22
LEDs and Heat: Managed or Micromanaged by Dan Jacobs, OPTEK Technology	p30
Advanced Thermal Management Materials for LED Packaging by Carl Zweben, Ph. D., Advanced Thermal Materials Consultant	p34
Thermally Conductive Plastics: Balancing Material Properties with Application Needs by Dr. Ir. R.H.C. Janssen, Dr. Ir. L. Douven, Dr. H. K. van Dijk, DSM Research	p38

■ Drivers

Driver Design Based on System Blocks by Jon D. Pearson, Cypress Semiconductor Corp.	p42
---	-----

Annual LED professional Review (LpR) Article Index 2009	p46
--	-----

LED professional – Patent Report	p48
---	-----

Advertising Index

SHARP	p C2
AVAGO	p 4
KINGBRIGHT	p 9
CIE Vienna	p 9
KUNZE FOLIEN	p 10
CREE	p 11
VOSSLOH-SCHWABE	p 14
EUROLED	p 15
OSRAM	p 17
DENKA	p 20
TAIWAN INT. LIGHT. SHOW	p 21
OCEAN OPTICS	p 23
GZ INT. LIGHTING EXHIBITION	p 25
LED LIGHTING TAIWAN	p 29
MINLEON	p 29
ROHM	p 31
FISCHER ELEKTRONIK	p 33
SIGNCOMPLEX	p 37
INT RD. LAMP LIGHTING FAIR	p 45
LIGHTING JAPAN	p C3
TRIDONIC.ATCO	p C4

Imagine...

the Perfect Picture

Your Imagination: 76,500 excited fans watching an instant replay of their team on a gigantic 1750 inch flat-panel LED scoreboard thinking that's the Perfect Picture.

Our Innovation: Avago's LEDs are the world's brightest for Electronic Signs and Signals.

- Super wide viewing angle of 115°–120° including a built-in reflector that increases the intensity of the light output.
- The black top surface and full black body of the LED deliver enhanced contrast for color sign applications.
- Water-resistant (IPX6) design for environmentally harsh applications.

If a commitment to technical excellence and innovative solutions in Signs and Signal applications is critical to your design, contact Avago for a free sample:

www.avagoresponsecenter.com/433



AVAGO
TECHNOLOGIES

Your Imagination, Our Innovation

Project News

Energy-Saving LED Showcases Shed New Light on Denmark's Crown Jewels

New solid-state showcase fixtures utilizing LUXEON® Rebel LEDs are changing the way that Denmark's Rosenborg Castle lights its popular collection of crown jewels and decorative objects, enabling an 80% energy savings as well as a dramatic reduction in incandescent-generated heat that threatened to damage the royal relics. The new PinoLED light strips were created by Danish LED lighting engineering firm I-NO in collaboration with Future Lighting Solutions, Danish lighting distributor Lumodan, and DTU Fotonik, the department of Photonics Engineering at the Technical University of Denmark.



I-NO's PinoLED assemblies are used in the display cabinets at Denmark's Rosenborg Castle to reduce energy consumption and beat the heat inside the cases.

The PinoLED light bars utilize a proprietary DTU Fotonik color mixing strategy to achieve the 2200 K color temperature considered optimal for lighting gold by combining warm white and red LUXEON Rebel LEDs and then adding a carefully selected optical filter to reduce unwanted colors. Color bins and filters are selected with the assistance of proprietary I-NO color mix calibration software, eliminating the need to make multiple prototypes from different LED bins to produce the desired color values.

"True 2200 K light cannot render saturated blue colors because it contains very little blue. That's why the blue backdrop in both the incandescent and initial LED scenarios washed out to gray. The issue was devising a way to enhance the blue without raising the color temperature," said I-NO CEO Peter Selmer Gade. "The solution both for that and for selecting the most appropriate LED reels depended on getting a precise color breakdown for each LUXEON Rebel color bin."

Future Lighting Solutions played a critical role in facilitating the new light strips, including providing advanced color binning, inventory management, and spectral power distribution data on all warm white LED color bins. I-NO's software uses this color data to generate a color mixing formula based on the characteristics of the individual color bin, making it possible to create the required color effects with almost any warm white LUXEON Rebel color bin simply by changing the optic filter and drive current.

I-NO also refined the Lumodan/DTU Fotonik system design using LUXEON Rebel LEDs and custom components. The finished PinoLED system:

- Tripled the light output over the earlier LED-based prototype by driving the LUXEON Rebels at 600 mA
- Deepened the cases' royal blue background by utilizing color bins with higher blue content as well as using an optical filter that retained more blue light
- Reduced energy use by 80%, consuming just 26 W per showcase compared to 150 W for the incandescent originals
- Beat the heat inside the showcases, reducing the incandescent-caused 12-degree difference between the room and the cases to less than 1 degree.
- Expedited LED selection by using I-NO's proprietary software to analyze available color bins for the desired color composition

This approach has enabled Rosenborg Castle to enhance its crown jewel display by deepening the royal blue of the showcase backdrops. Previously the backgrounds washed out to gray, lessening the regal impression as well as the eye appeal. ■

Product News

New Cree EasyWhite™ Bins Simplify LED Design and Improve Color Consistency

Cree, Inc. (Nasdaq: CREE), a market leader in LED lighting, announces EasyWhite™ bins, an LED innovation that both simplifies LED system design and improves LED-to-LED color consistency. EasyWhite bins are offered in 3500 K, 3000 K and 2700 K color temperatures and are 75% smaller than the ANSI C78.377 standard color regions.

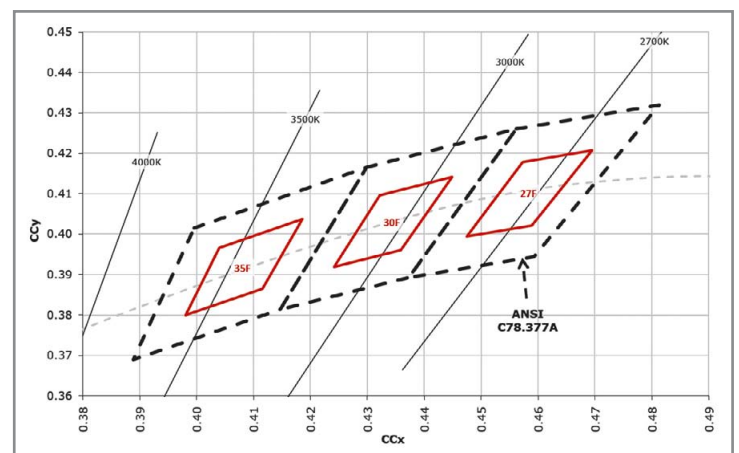

Cree Xlamp MC-E EasyWhite™ binning information.

Prior to this innovation, customers had to manually mix multiple LED bins to achieve consistent color points. For many LED lighting applications, such as MR-16 light bulbs, color-mixing multiple LEDs was complex and undesirable.

"We've listened to our customers' requests for tighter color points, especially for warm and neutral white lighting applications," said Paul Thieken, director of marketing, LED components at Cree. "Our goal is to increase end-product color consistency for all lighting applications, and EasyWhite bins can reduce manufacturing complexity and inventory needs. Customers can now buy LEDs just like traditional light bulbs, by specifying CCT and light output."

Cree's multichip XLamp® MC-E LEDs are the first LEDs available in EasyWhite bins. The XLamp MC-E EasyWhite LED, at 3000 K CCT, can produce up to 560 lumens when driven at 700 mA. This single LED is an ideal replacement for 20 to 35-watt halogen light bulbs in indoor lighting applications such as accent, track and pendant lighting. XLamp MC-E EasyWhite LEDs are available in sample quantities now and in production quantities with standard lead times. ■

Stanley Electric Introduces 5 W High Power LED Modules

Stanley Electric Co Ltd of Japan has introduced a new high power LED Module for General lighting Applications.

Supplied in cool white (5000 K) colour, with up to 1,320 Luminous Intensity (cd). Combining Stanley's leading edge LED know how with our distribution control technology as derived and used in the Automotive head lamp division.



The LLM1WM series consists of 4 distinct light modules. These are narrow, middle and wide angle lenses; with the fourth being a Fresnel lens type.

With a size of 41 mm (LxW) and 20 mm high it is a compact size given the light output and lens design. Featuring a high intensity light output (5W) and available as a module for installation into a housing of a manufacturers choice.

Specific applications include: road lights, street lights, parking lights, security lights, and sign lights. ■

Sharp Introduces New Lineup of Nine High Color Rendering LED Lighting Devices

Sharp Corporation will introduce nine new LED lighting devices, including SMD chip LEDs suitable for planar lighting fixtures, and Zenigata LED devices ideal for use in spot lighting and bulb-shaped lamps.

Product name	LED lighting device		
	SMD chip LED	Zenigata LED	
Type	GM2BB50BMOC (5000K)	GW5BTF50K00 (5000K)	GW5BTC50K00 (5000K)
Model name (color temperature)	GM2BB40BMOC (4000K)	GW5BTF30K00 (3000K)	GW5BTC30K00 (3000K)
	GM2BB30BMOC (3000K)	GW5BTF27K00 (2700K)	GW5BTC27K00 (2700K)
Input power	0.5W	6.7W	3.6W
Color rendering index (Ra)*	85	87	
Sample price	70 yen	1,200 yen	800 yen
Start of production	December 25, 2009		
Monthly volume	10 million units	800,000 units	

The new high colour rendering SMD chip LED and Zenigata LED devices.

With LED rapidly replacing conventional lighting products, more and more people are demanding LED lighting capable of depicting illuminated objects such as foods or flowers with colors close to those perceived under natural light.

To meet such needs, Sharp has developed a series of new High Color Rendering LED lighting devices in two package styles. The SMD (surface mount device) chip LEDs are based on a proprietary double molded structure adopted for use in the LED backlights of AQUOS LCD TVs, and feature improved light extraction efficiency to deliver a luminous flux of 38 lumens, the top level in the industry in the 0.5-Watt input power class (GM2BB50BMOC). Zenigata LED devices are now even more compact with approximately half (56%) the surface area of previous models, and provide easy "drop-in" integration into lighting fixtures and equipment. ■

Triple Output LED Driver Drives Up to 30 x 300 mA LEDs & True Color PWM Dimming

Linear Technology Corporation announced the LT3492, a 2.1 MHz DC/DC converter designed to operate as a three-channel constant current LED driver. Each of the LT3492's three channels can drive up to ten 300 mA LEDs in series, enabling it to drive up to 30 x 300 mA LEDs at efficiencies up to 96%. All three channels are operated by an independent True Color PWM™ signal, enabling each to be dimmed independently to ratios as high as 3,000:1. A fixed frequency, current mode architecture ensures stable operation over a wide range of supply and output voltages. A frequency adjust pin enables the user to program the

frequency between 330 kHz and 2.1 MHz to optimize efficiency while minimizing external component size. The LT3492's thermally enhanced 4 mm x 5 mm QFN (or thermally enhanced TSSOP) package provides a highly compact solution footprint for up to 50 W LED applications.

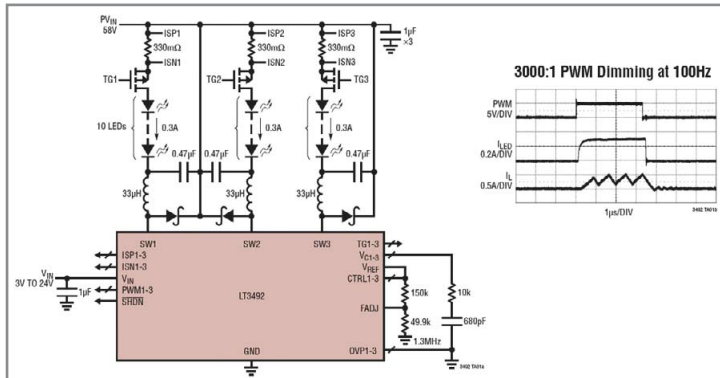

Typical Application with the LT3492.

The LT3492 senses output current at the high side of the LED, enabling buck, buck-boost or boost configurations. With an external sense resistor, the user can program the output current range of each channel. Each of the three independent driver channels utilizes an internal 600 mA, 60 V NPN switch and has a built-in gate driver for PMOS disconnect. Other features include open LED protection and thermal limiting.

Typical applications:

- RGB Lighting
- Billboards and Large Displays
- Automotive and Avionic Lighting
- Constant-Current Sources

Summary of features: LT3492

- True Color PWM™ Dimming Delivers up to 3000:1 Dimming Ratio
- Built-In Gate Driver for PMOS LED Disconnect
- Three Independent Driver Channels with 600 mA/60 V Internal Switches
- Operates in Buck, Boost & Buck-Boost Modes
- Wide Input Voltage Range: Operation from 3V to 30 V, Transient Protection to 40 V
- CTRL Pin Accurately Sets LED Current Sense Threshold over a Range of 10mV to 100mV
- Adjustable Frequency: 330 kHz to 2.1 MHz
- Open LED Protection
- 28-Lead (4 mm x 5 mm) QFN & TSSOP Packages

The LT3492EUFD is available in a thermally enhanced 28-lead 4mm x 5mm QFN package, and the LT3492EFE is available in a thermally enhanced TSSOP-28 package. Pricing starts at \$3.70 and \$3.85 each, respectively in 1,000 piece quantities. Industrial grade versions, the LT3492IUFD and LT3492IFE, are tested and guaranteed to operate from -40°C to 125°C operating junction temperature. ■

Allegro LED Drivers Include MIC, Power MOSFET

The LC5205D and LC5210D off-line LED driver IC series include both a main controller integrated circuit (MIC) and a power MOSFET. The high-voltage capability allows direct connection to a wide range of supply voltages ranging from 25 to 400 V (recommended).

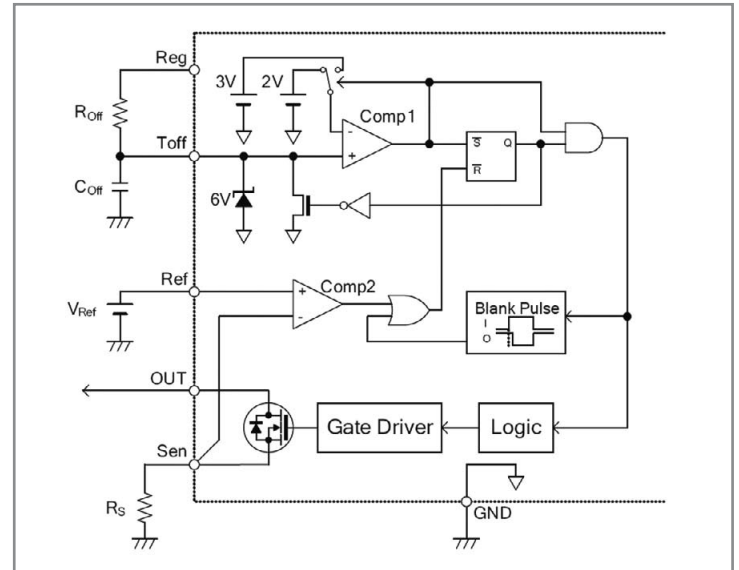

The current control circuit of the LC52xx series.

Features:

- Supply voltage, V_{BB}, 450 V maximum, 25 to 400 V recommended; Note: lowest voltage can vary depending on LED loads
- Output current I_{O(max)} options:
 - 0.5 A, LC5205D
 - 1.0 A, LC5210D
- Constant current control circuit:
 - Fixed off-time PWM constant current control, off-time adjustable by external components
 - Externally adjustable output current by input voltage to REF pin
- Output current dimming by external PWM signal; low signal to T_{OFF} pin shuts off output current, and PWM signal input to that pin enables dimming
- Undervoltage lockout protection (UVLO)
- Overcurrent protection (OCP); latched in response to the short-to-GND condition
- Thermal Shutdown protection (TSD); protects IC from damage due to excess temperature, auto-restart when temperature drops below threshold

Output current for the LC5205D is 0.5 A and for the LC5210D, 1 A. Packaged in a standard 8-pin DIP, with pin 7 removed for greater creepage distance from the supply pin, the series also features overcurrent and thermal-shutdown protection. ■

LDA24 – High Efficiency LED Driver Modules

The LDA24 constant current LED drivers, all with dimension of 22.1 x 12.55 x 8.5 mm are now available at MSC Vertriebs GmbH. Developed by YDS these ready-to-use driver modules supply a regulated constant output current, which can be dimmed down to zero by an external PWM signal. They are designed for an input voltage range of 5 to 36 V. The load voltage can range from 2 to 34 V, allowing it to drive more than ten series connected LEDs with an efficiency of up to 95%. In shutdown mode the input quiescent current drops below 400 μ A.

The LDA24 series standard ratings are 300, 350, 500, 600 and 700 mA, other output current levels can be made to customer specifications. The specific model's output current is kept constant to $\pm 5\%$, regardless of the number of series connected LEDs. Over temperature protection, constant short circuit protection, low ripple and noise as well as a MTBF rating of 2x10⁵ hours are additional benefits.

The LDA24 series LED drivers are individually tested and ready-to-use. Application developers save time and effort creating and optimizing individual solutions and can fully concentrate on system design. The LDA24 series models are RoHS compliant and allow a soldering temperature up to 265°C. ■

TSMC Announces Process Technologies For Integrated LED Drivers

Taiwan Semiconductor Manufacturing Company, Ltd. (TWSE: 2330, NYSE: TSM) unveiled modular BCD (Bipolar, CMOS DMOS) process technologies targeting high voltage integrated LED driver devices.

The new BCD technologies feature a voltage spectrum running from 12 to 60 V to support multiple LED applications including LCD flat panel display backlighting, LED displays, general lighting and automotive lighting. The technology portfolio spans process nodes from 0.6-micron to 0.18-micron with a number of digital core modular options for varying digital control circuit gate densities. The CyberShuttle™ prototyping service supports the 0.25-micron and 0.18-micron processes for preliminary function verification.

The new processes provide a number of integration features that reduce a system's component counts. The robust high voltage DMOS capability provides MOSFET switch integration to reduce the bill of materials (BOM). The integrated passive component options include high voltage bipolar, high voltage, high precision capacitors, high resistance poly and Zener diodes to reduce external passive component count and significantly reduce circuit board area.

The DMOS process supports foundry's leading R_{ds(on)} performance (i.e.; 72 mOhm per mm² at BV>80 volts for a specific 60 V NLD MOS) and its high current driving capability optimizes device sizes that enhance power efficiency. A robust safe operating area (SOA) makes it ideal for both power switch and driver design. Fine detailed characterization also provides a useful reference to optimize the design budget for optimum chip size.

On the CMOS side, a 5-volt capability supports analog Pulse Width Modulation (PWM) controller design elements and the 2.5-volt and 1.8-volt logic cores are optional modules for higher-level digital integration. In addition, logic compatible one-time programmable (OTP) and multi-time programmable (MTP) memory options are available for enhanced digital programming design.

"The new BCD technologies for LED drivers are very leading edge in driving device integration. The associated PDKs feature highly accurate SPICE models that really enhance the potential for easy single chip design," points out George Liu, Director, Industrial Business Development. "In addition, mismatching models help optimize current mismatching performance in multi-channel LED driver designs." ■

Infineon Introduces Energy Efficient Low-Cost Driver Family for Half Watt LEDs

Infineon Technologies AG is extending its portfolio of energy efficient lighting ICs with a new family of low cost linear LED drivers. The new BCR320 and BCR420 product families address the burgeoning market for energy-saving and environmentally friendly light-emitting diode (LED) lighting solutions. Specifically designed for driving 0.5 W LEDs with a typical current of 150 mA to 200 mA, these LED drivers feature a negative thermal coefficient contributing to a long lifetime of LEDs and a digital inter-face for a pulse width modulation (PWM) signal for dimming.

With the recent introduction of higher efficiency 0.5 W LEDs this class of products is expected to be adopted in a wider range of applications. However, currently available resistor solutions for biasing LED current have significant disadvantages such as inhomogeneous light output and reduced lifetime of LEDs. Alternatively, switch mode drivers do not meet the required price point for 0.5 W LED applications, and drive up the number of parts and the complexity of driver circuit.

With both devices, the usage of inductors, capacitors and free-wheeling diodes can be avoided, resulting in cost savings and a very small PCB space requirement. The elimination of electrolytic capacitors can also contribute to the extended lifetime of the LED system.

The BCR320 products are designed for a peak output current of up to 300 mA. For continuous operation a maximum nominal current of 250 mA is recommended. While this device has an internal breakdown voltage of typically 20 V, it can be operated at supply voltages of 24 V or higher since the driver is operated in series with the LEDs.

Kingbright

www.kingbright-europe.de

+49 2835 - 44 46-0

Kingbright's KPTD-1608 series Dome-lens SMD-LED in 0603 package

Features:

Dimensions = 1,6 mm x 0,8 mm x 0,95 mm

Lens height = 0,7 mm

Luminous intensity up to 3.000 mcd @ 20mA

Available colours = red, green, yellow, orange und blue

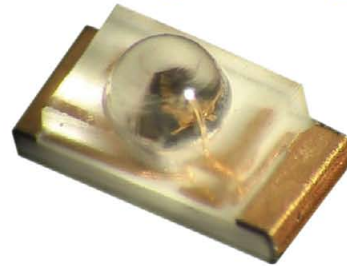

Quality — Efficiency — Innovation — First-class service

Kingbright Electronic Europe GmbH • Lindenau 7 / Gewerbegebiet • D-47661 Issum • Phone: +49 (28 35) 44 46-0 • Fax: +49 (28 35) 44 46-29

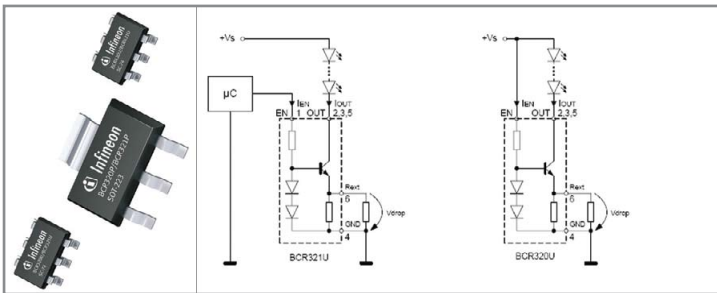

The new BCR320 and BCR420 LED drivers and the typical application circuits: Enabling with PWM by micro controller and enabling by connecting to V_s .

The BCR320 is targeted at general lighting, architectural and mood lighting applications. Another fast growing segment is shop lighting where 0.5 W LEDs are preferred in order to spread the light and avoid glare. BCR320 devices have a negative thermal coefficient, which means that in case of temperature increase the current is lowered with a slope of 0.2% / K. The BCR320U and BCR321U versions are available in a very small SC-74 package (2.9 x 2.5 x 1.1 mm) with 1 W power dissipation. The BCR320P and BCR321P types will be offered in a SOT-223 package (6.5 x 7.0 x 1.6 mm) providing a higher power dissipation of 2 W. The BCR321U and BCR321P versions both offer a logic level input for dimming.

The BCR420 products have a higher internal breakdown voltage and a lower output current than the BCR320 devices. The internal breakdown voltage is typically 50V and the nominal output current is 150mA. The BCR420 LED drivers are intended for use in similar applications as mentioned above for a maximum drive current of 150mA. In addition, qualification for use in automotive applications, based on AECQ 101 certification, is ongoing. BCR420 and BCR421 products are available in SC-74 package. The BCR421 is the dimmable version with a microcontroller interface. ■

Internationale Beleuchtungskommission
Commission Internationale de l'Eclairage
International Commission on Illumination

Lighting Quality & Energy Efficiency

March 14–17, 2010
Vienna, Austria



- Highlights:
- Surveys of experimental projects
 - Lighting techniques & scenarios
 - Integrated approaches in Lighting Design
 - Lighting quality criteria
 - Future possible lighting schemes
 - Methods to compare lighting installations
 - Case studies of energy-efficient lighting
 - Review of energy-efficient lighting control systems
 - Energy efficiency & environmental compatibility

<http://vienna2010.cie.co.at>

For further information please contact:
CIE Central Bureau, Keigelgasse 27/3, 1030 Vienna, Austria
Phone: +43-(0)-1-714 31 87, Fax: +43-(0)-1-714 31 87-18
Email: vienna2010@cie.co.at

Kunze Offers Superior Heat Management for LEDs

The triumphant success of LED technology set in – at the latest – with the development of High Power LEDs. Continuous improvement of light efficiency, colour, and cost-benefit ratio allows for an ever-increasing operative range. LED technology is employed in the automotive industry, in displays and mobile devices as well as in the lighting of roads and buildings. LEDs are more robust than conventional lamps, their energy efficiency and durability are superior, they are small and they operate at low voltage.

Despite these obvious advantages, there are specific guidelines to follow when choosing design and material: of their energy feed, serial produced LEDs convert about 30% into light, while approx. 70% are lost as heat. This calls for sophisticated heat management. LED lighting systems and fast processors require a heat-conducting interface material capable of efficiently conducting heat loss away from the component towards the heat sink. If this is not provided, the LED's lifespan is reduced dramatically.

Manufacturers of LEDs take heat management very seriously, including the aspects of cost-benefit ratio, the amount of space available, and application efficiency. Over the past years, rapid technological progress and increasing power density of high-performance LEDs has had manufacturers and users facing new challenges in the field of heat management.

Outdoor or automotive applications are subject to drastic changes in temperature and other environmental factors which can lead to unpredictable effects in lighting. Production costs are necessarily increased by the indispensable application of heat-conducting materials, but they can be minimized by the right choice of material and incorporation of that material at an early stage of the development process.

For LED applications which, due to their build, require electric insulation of the semiconductor, ceramic-filled silicone is preferably used. Its thermo conductivity and puncture strength are excellent, and it boasts both low thermal contact resistance and good double-sided adhesion. Its temperature resistance is superior to that of double-sided adhesive acrylic tape, making it reliable and user-friendly.

Part	KU-	SAS20
General properties		
Material		Silicone
Colour		White
Thickness	µm	+15 200
Outgassing (LMW Siloxane, Generating Gas Analysis)	ppm	Σ D3 -D10 = 1
Mechanical and electrical properties		
Peeling strength ¹	N/cm	6,4
Breakdown Voltage (Voltage ramp) ²	kV	6,5
Breakdown Voltage (Voltage steps) ³	kV	5,0 at 25°C / 4,5 at 80°C
Thermal properties		
Thermal conductivity	W/mK	1,0

¹ 180° Peeling strength with Al plate, at 23°C, peeling speed: 300mm/min, sample was boned using a 2kg roller, measurement follows after 10 min.
² Voltage ramp 1000 V/s
³ Step by step voltage increments until dielectric breakdown

Main Specification of the KU-SAS HEATPAD®.

Keep your LED's cool

Thermal Conductive Interface Material KU-SAS 20
with special Performance



- Thermal conductivity 1.0 W/m x K
- Low thermal resistance
- Double-sided adhesion, shear strength 50 N/cm² at 25°C
- Superior puncture strength (6.5 kV)
- Higher temperature stability (up to +150°C) than other materials such as adhesive acrylic tapes
- Form of delivery: on bobbin, as sheets, blanked or cut to customer specifications



Kunze
The Heatmanagement Company

Kunze Folien GmbH · PO box 1562 · D-82036 Oberhaching
Telephone + 49 (0) 89 66 66 82 - 0 · Fax + 49 (0) 89 66 66 82 - 10
sales@heatmanagement.com · www.heatmanagement.com

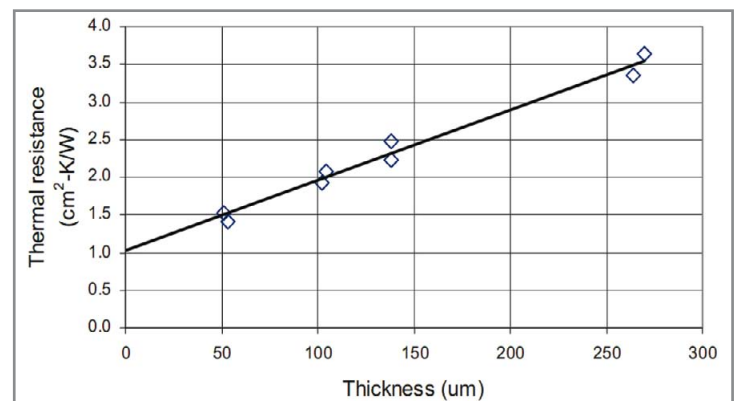

Thickness versus thermal resistance (measured by laser-flash method).

Kunze Folien GmbH have expanded their product range by a silicone foil especially suited for LED applications which meets the increasingly demanding requirements regarding efficient heat conductance. KU-SAS HEATPAD® is a double-sided adhesive silicone foil with extraordinary thermal properties and powerful adhesion. The softness of this foil compensates perfectly for any potential unevenness of the LED carrier, therefore outmatching other interface materials. KU-SAS can even be easily applied to larger surfaces such as LED modules. ■



**CREE XLAMP® LEDs.
INSTALLED IN MORE LUMINAIRES IN MORE PLACES.
THAT'S LIGHTING-CLASS.**

Built to deliver energy-efficient beautiful light, Cree XLamp LEDs outperform all others in brightness and efficacy. And they prove it daily at thousands of commercial, architectural and residential installations worldwide.

Contact a Cree Solutions Provider or authorized distributor at www.cree.com/xlamp or call 800-533-2583.



XLamp XR-E
The proven platform.
Up to 114 lumens
at 350 mA.

XLamp MC-E
Up to 456 lumens
at 350 mA —
4x the flux, same
size as an XR-E.

XLamp XP-E
Same output as
the XR-E at 20%
the package size.



AVX Expands LED Lighting Connector Family

AVX Corporation has expanded its wire-to-board connector product offering to include board-to-board connectors specifically designed for the LED lighting industry. Designated the 9159 series, the cost-effective connectors provide design flexibility by offering both card edge (one-piece) and plug-and-socket (two-piece) interconnect options. The connectors feature a small footprint, making them ideal for applications where multiple printed circuit boards need to be plugged together, such as LED lighting strips.



The two-piece connector version is surface mounted on one side of the PCB.

The double-ended card edge version provides a simple and direct connection to both ends of a standard PCB with tin plated pads in 2, 3, 4 and 5 positions. These 2.0 mm pitch connectors support 3 A current and 250 voltage ratings. The connectors are 5.0 mm high and come in both black and white options.

The two-piece connector version is surface mounted on one side of the PCB, which allows the LEDs to be placed on the other side to maintain consistent spacing. These 3.0 mm pitch and 3.0 mm high connectors are only 5.5 mm wide when mated together, thus maximizing board space for other components. Tooled in 2, 3, 4, 5 and 6 position, these connectors are also available in black and white options.

The new 9159 series connectors provide simple, yet reliable termination of PCBs. The 9159 series is tested to industrial levels of shock, vibration and temperature cycling per IEC specifications to assure they can withstand the harsh environments they were designed for. The connectors are ideal for use in LED lighting strips for sports arena signs, display cases, lighted cabinets, fluorescent tube replacement and architectural lights used for building feature enhancement or internal feature lighting. The connectors are also suited for rugged industrial and automotive applications.

Both versions of the 9159 series connectors are rated in current at 3 A and have an operating temperature ranges of -55°C to +125°C. ■

Tyco Electronics Offers New Screw-Down Jumper Assembly

Tyco Electronics has launched a new board-to-board screw-down jumper assembly for use in LED lighting strips, lighting controls, and channel lettering, and a new RoHS-compliant G13 style surface mount (SMT) assembly and end-cap cover for the solid state lighting (SSL) industry.

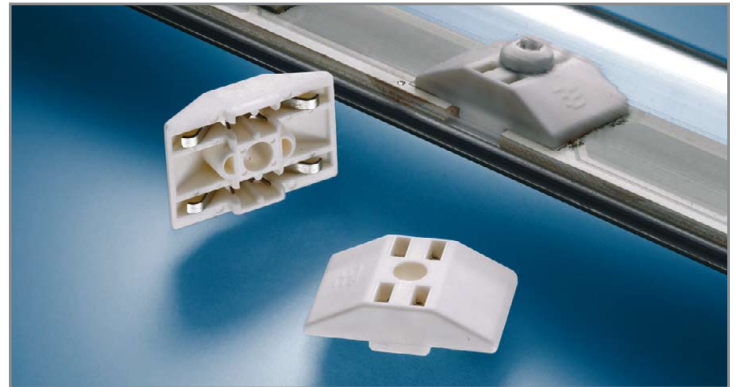

Tyco's board-to-board screw-down jumper assembly.

Tyco Electronics has launched a new board-to-board screw-down jumper assembly for use in LED lighting strips, lighting controls, and channel lettering. The RoHS-compliant jumper, which was originally designed for T8 and T12 fluorescent retrofit tubes, specifically serves the solid state lighting (SSL) market.

The product simplifies the manufacturing process of the above lighting applications by providing the electrical connection between adjacent printed circuit boards (PCBs) arranged in a string of LED PCBs. The screw fastens to threaded holes in an aluminum clad PCB base, or into a separate aluminum heat sink used with FR4 boards.

The two-position jumper fits onto a 16.50 mm [.650 inch] wide PCB with features that maintain a 7.0 mm [.276 inch] spacing between adjacent boards. The ETL recognized board-to-board connector meets UL 1977 standards.

Product Features:

- 2-position connection assembly
- Connector assembly fits onto 16.50 mm [.650] wide printed circuit board
- 7.0 mm [.276] printed circuit board spacing

Applications:

- T8-T12 Fluorescent Retrofit LED Bulbs
- LED Lighting Strips
- LED Lighting Controls
- Channel Lettering

Product specifications include a current rating of 5 A, operating temperature of -40 to +105°C, 250 VAC/ 250 VDC voltage rating, and a 1500 VAC dielectric withstanding voltage rating. ■

Neopac Announced Neobulb Epoch VIII for Indoor High Bay Down Light

NeoBulb Lighting, Ltd., a subsidiary of NeoPac Lighting Group, recently announced NeoBulb Epoch series. With technology tackled the highest power density for the LEDs illumination, the LEDs indoor lamps can replace traditional 400 W mercury lamps and be mostly suitable for a variety of commercial and industrial places such as warehouses, plants, halls, airports, train stations, stadiums and showrooms that need high quality illumination.



Neobulb Epoch VIII LEDs lamps replace traditional mercury lamps in different industrial and commercial applications.

Items	Epoch VIII - With diffuser (White)	Epoch VIII - Without diffuser (White)
LED-Power Consumption	112 W	112 W
System Power Consumption	137 W	137 W
LEDs Initial Luminous Flux	8770 lm	8770 lm
LEDs Maintained Luminous Flux	8000 lm	8000 lm
Lighting Fixture Luminous Flux	6480 lm	7200 lm
Max. Illuminance (E _{max}) (@8m)	>225 lux	>256 lux
Correlated Color Temperature (CCT)	5000~7000 K	5000~7000 K
Color Rendering Index (CRI)	>75	>75
Light Source(NeoPac® Emitter)	14 Watt	14 Watt
Junction Temperature (T _j)(T _a = 25°C)	60°C ± 1°C	60°C ± 1°C
Sys. Thermal Resistance (R _{ja})	0.31°C / W	0.31°C / W
Dimensions (DXH) (mm)	420 (D) x 431 (H)	420 (D) x 431 (H)
Cut Out Size (mm)	400	400
Net weight (approx.)	10.6 kg	10.6 kg

NeoBulb Epoch series can replace traditional down lights. There are two types for the Epoch series - Epoch IV (56 W), and Epoch VIII (112 W). Both lamps are ingeniously designed by using 4 pieces and 8 pieces of 14 W NeoPac Light Engines, respectively. NeoPac Light Engines, beside its high power density (14 W/Engine) while keeping lowest constant junction temperature down to 60°C, together with coupled narrow or wide secondary beams by the changeable optics to meet the needs for various circumstances that need ultra-high-power lightings. The optics can offer precise beam control for commercial lighting applications with two available cut-outs (Ø200 mm and Ø400 mm). The Correlated

Color Temperature (CCT) is available for the warm white between 2,800 K and 3,000 K, or for the cool white between 5,000 K and 7,000 K. Epoch IV is capable of providing maintained luminous flux at 4,000 lm while Epoch is at VIII 8,000 lm. Thanks to the unique thermal management system by NeoPac, the junction temperatures for both types can well be controlled around 60°C and can have an astounding lifespan up to 60,000 hours.

NeoBulb Epoch series, just like all other NeoBulb made luminaires, are ingeniously engineered LEDs lighting devices that are designed on the basis of the proprietary NeoPac Universal Platform (NUP). Empowered by this sustainable and structural LEDs technological platform, every NeoBulb product can perform excellently at ultra-high power with high luminous flux, low junction temperature (T_j), and extraordinary long useful life.

Jeffrey Chen, chairman of NeoPac Lighting Group, said: "Actually, the 112 W Epoch VIII is the king of LEDs lamp for indoor high bay down lighting applications and have been already broadly adopted with successful result at the showrooms of some world-wide leading automobile and railway companies in Japan, as well as have been installed at warehouses of famous big companies in Germany. The achievements wouldn't be too much more if you come and join us. Why not speed up the pace by replacing traditional lamps to help on saving the earth, NeoPac offers well-packaged offers for you if you come together on the campaign against global warming. This low cost barrier is optioned exclusively within a limited period at a first come first serve basis only. It's an AIS (Assembly In Site) solution." ■

Klipsch to Illuminate Audio Industry with New LED LightSpeaker

Klipsch, a leading global speaker manufacturer, is introducing what is possibly the most innovative design to hit the audio industry in recent years. Winner of a 2010 CES Innovations Award, the patented Klipsch® LightSpeaker® is the first product to combine efficient LED lighting and wireless ambient sound into a single unit that installs like a light bulb.



Closeup of the Klipsch® LightSpeaker®.

"Today's consumers are overloaded with complex technologies, and the LightSpeaker is designed to enrich their lives without complication," said Klipsch president Paul Jacobs. It offers brilliant light, reduces energy costs and creates a multi-room ambient music system in mere minutes. There's no wiring, no retrofitting and no software to deal with."

The LightSpeaker, which comes complete with a dimmable LED bulb and full-range speaker, fits 5- and 6-inch recessed light fixtures with a standard Edison socket. Upcoming accessories will allow the LightSpeaker to accommodate hanging light fixtures as well as floor and table lamps.

The speaker uses a 20 W high-performance, low-distortion digital amplifier to deliver energy efficient sound. Furthermore, the LightSpeaker's 2.5-inch wide dispersion driver uses digital signal processing to optimize high- and low-frequency output for a full spectrum of sound.

In order to deliver music wirelessly, the LightSpeaker relies on a standalone transmitter. A music source, such as a laptop, iPod or CD player, connects to the transmitter and it wirelessly sends the sound to the LightSpeaker. The transmitter's 2.4 GHz wireless technology accommodates up to eight LightSpeakers, equaling stereo sound in multiple rooms. You can connect two music sources to the transmitter, as well as establish two separate listening zones. The transmitter or remote controls the sources, zones, lighting levels and volume.

The LED bulb is rated for 40,000 hours of use and can last over 15 years. It also reduces daily lighting expenses by 80 percent, using 10 watts to produce light that's bright enough to replace up to a 65 watt bulb. Unlike incandescent bulbs, the LightSpeaker LED bulb contains no mercury or halogen gases and produces almost no heat.

LED Light Features:

- 10 W super bright LED provides a sharp crisp light that is easy on the eyes.
- LED outputs the light suitable to replace up to a 60 W incandescent bulb
- Long Lasting LED is rated for over 25,000 to 40,000 hours of use (15 to 20 years average use)
- LED Light is fully dimmable and is controlled from either the remote or the light button on the transmitter

A bundled package, consisting of two LightSpeakers, a transmitter, radio frequency remote, mini jack to RCA plug cable, lenses and trim, retails for \$599. Single LightSpeakers are also available for \$249 each. Klipsch will begin selling the LightSpeaker on klipsch.com later this month, with broader distribution slated for March.

"A LightSpeaker package eventually pays for itself, through savings on professional installation, separate audio components and energy consumption," concluded Jacobs. "Plus you can take it with you if you move." ■

light+building

light+building, Frankfurt
11 to 16 April 2010
Hall 4.0, Booth B60

- **350 mA constant current**
- **Up to 42 W LED output**
- **Efficiency > 90%**
- **Protection against transient mains peaks: 4 kV**
- **Ideal for street and general lighting applications**



Energy-Efficient LED Street Lighting with Vossloh-Schwabe



Designed predominantly with street and general lighting applications in mind, Vossloh-Schwabe's new 42 W LED driver can be used to operate up to 35 high-power LEDs at 350 mA. On top of that, the driver provides excellent protection against transient mains peaks of up to 4 kV and delivers an efficiency coefficient in excess of 90%, all of which go to make VS' new LED driver the ideal choice for operating energy-efficient lighting systems.

Tap into the savings potential created by VS LED technology.

Vossloh-Schwabe: A New Lighting Experience

www.vossloh-schwabe.com



euroLED

2010



Europe's Leading Conference, Exhibition & Gala Dinner in Solid State Lighting

9th & 10th June 2010, Ricoh Arena, Coventry, UK

Premier sponsors:

anglia lighting



OSRAM
Opto Semiconductors

eurolight sponsor:



For further information visit www.euroLED.org.uk or call +44(0)121 250 3515

LedEngin, Inc. Launches LED LuxPAR™ Product Family

LedEngin, Inc., a leading innovator in high performance LED lighting technology for commercial buildings, LEED construction, restaurants, casinos and museums, announced the launch of its LuxPAR family of LED lighting products and immediate availability of the first product, PAR38.



In addition to the PAR38 lamp, LedEngin will also offer PAR20 and PAR30 lamps worldwide in Q1 2010.

The company's PAR38 lamp represents the industry's first truly dimmable LED lamp with smooth dimming to 1% light levels, and features LedEngin proprietary LEDs and optical designs that deliver highest lux, superior light quality and longevity for measurable energy reduction and cost savings as compared with halogen and metal halide lamps. LuxPAR products will be offered in multiple color temperatures and spot, narrow flood and flood beam distributions.

Main Technical Features:

- 75% power savings over 75 W halogen and > 10 times the service life
- Precision optic delivering high quality smooth gradient light beam pattern
- Conforms to standard PAR38 shape
- Industry leading lumen maintenance and color point stability
- 110 VAC
- Power factor 0.93 for commercial installations
- Dimmable with standard dimmers
- UL, cUL, FCC pending
- Mercury and lead-free
- 3 year limited warranty

Applications:

- Retail
- Hospitality
- Museum
- General lighting

LuxPAR™ LED PAR38 combines LedEngin's industry leading high performance LED technology with optical, electrical, and thermal management solutions to deliver the lighting equivalence of a conventional 75 W halogen PAR38 lamp and the benefits of solid state lighting. LuxPAR delivers the quality and quantity of light required for a broad range of recessed and down lighting applications in spot, narrow flood and flood beams. ■

Event News

CIE 2010 – Where the Lighting World Meets

The Commission Internationale de l'Eclairage (CIE), founded in 1913, is the most respected International Lighting Organisation, which deals with all the different aspects of this subject and is one of four international standardization organizations recognized by ISO.

It is totally committed to the development of energy efficient lighting technologies and standards but without sacrificing safety, security and other important aspects of lighting quality. This can be achieved through the intelligent use of new technologies and a scientific understanding of the varied human needs for different types of lighting in different settings.

- A more efficient use of daylight augmented with the use of more efficient lamps and the latest lighting technology now enable us to save energy without sacrificing good lighting.
- Findings in medical science reveal that light plays important roles in maintaining optimum regulation of biological rhythms and hormones on a daily basis. However, the improper choice of lamps or luminaires (fixtures) and poor lighting design and/or lighting installation maintenance, can actually have negative consequences for health and also for traffic safety, personal security, work performance and well being.
- Electronic control systems enable us to adapt light levels and timing of artificial lighting to minimize energy consumption depending on the levels of available daylight and occupancy in buildings as well as traffic volumes on roadways.

Good lighting brings safety, security and a better quality of life to all but needs to be related to the supply of the correct amount of light and with good colour rendering, with the minimal use of resources.

The Conference

CIE 2010 "Lighting Quality & Energy Efficiency", March 14-17, 2010, Vienna will give an overview of what is being done in terms of (inter) national and regional legislation, regulations, directives and standards worldwide to ensure energy-efficient yet good quality lighting. Specialists in measurement and product quality, lighting and its effects on health, vision and colour, public lighting and lighting for transport as well as lighting design will present and discuss the latest developments.

The partners which join in the effort to provide a forum in order to achieve these ambitions goals are manifold: The International Electrotechnical Commission (IEC), the International Astronomical Union (IAU) as well as other organizations, e.g. the Professional Lighting Designers Association (PLDA), and naturally CIE's partners from the industry, such as Zumtobel, Philips Lighting and OSRAM or regional interest organizations, too, such as CELMA, the European Association of the Lighting Industry.

Programme

CIE 2010 will feature the latest achievements in the science and technology of light and lighting and we would like to give you a flavour of what the programme of CIE 2010 will be about:

"The CIE System for Visual Performance-Based Mesopic Photometry" will be presented by Dr Teresa Goodman, CIE Vice President Publications, Lead Scientist for Sensory Metrology, NPL (UK), Kevin McKinley, Deputy Secretary-General of the ISO, the International Standardization Organization, will give an inside view of the strategies in international standardization in terms of energy efficiency, whereas Prof. Tran Quoc Khanh, Head of the Laboratory of Lighting Technology at the Technical University of Darmstadt (Germany) will have his lecture on "LEDs & Lighting Quality". "Health and Safety Implications of New Lighting Technologies" will be the focus of Dr David Sliney's Keynote, President of the American Society for Photobiology.

CIE 2010 will offer a wide range of workshops which will deal among other things with Mesopic Photometry and Outdoor Lighting, the Non-Visual Effects of Lighting, Product Quality Issues of Solid State Lighting, Regional and National Standardization Policies as well as Innovative Solutions on Streetlighting.

Presented Papers and the Poster Exhibition provide an ample selection of what is being done worldwide to ensure Lighting Quality without sacrificing Energy Efficiency (and vice versa).

You will find the Final Programme for CIE 2010 "Lighting Quality & Energy Efficiency" online at <http://vienna2010.cie.co.at/Programme>. We invite you to view what the International Scientific Committee, chaired by Dr Janos Schanda, has provided for you.

Outline and structure have been newly composed owing to the fact that a high number of abstracts were received which showed the true interest of the lighting community in the conference subject. As the approach of CIE 2010 is to be a forum and a "show room" for best practices in a variety of fields and state-of-the-art research conducted worldwide the programme shall, consequently, reflect this attitude.

The scientific programme is accompanied by a small exhibition which can be visited during all three conference days as well as by social events, such as a Welcome Reception and a Gala Dinner. The City of Vienna would like to welcome you at a City Tour featuring the "Lights of Vienna".

We sincerely hope that we meet your expectations and invite you to take part in this truly international event during which scientists, policy makers, public interest groups and international agencies concerned with energy and lighting will come together to exchange ideas and formulate a way forward on how lighting can be used to reduce worldwide energy consumption without sacrificing lighting quality. ■

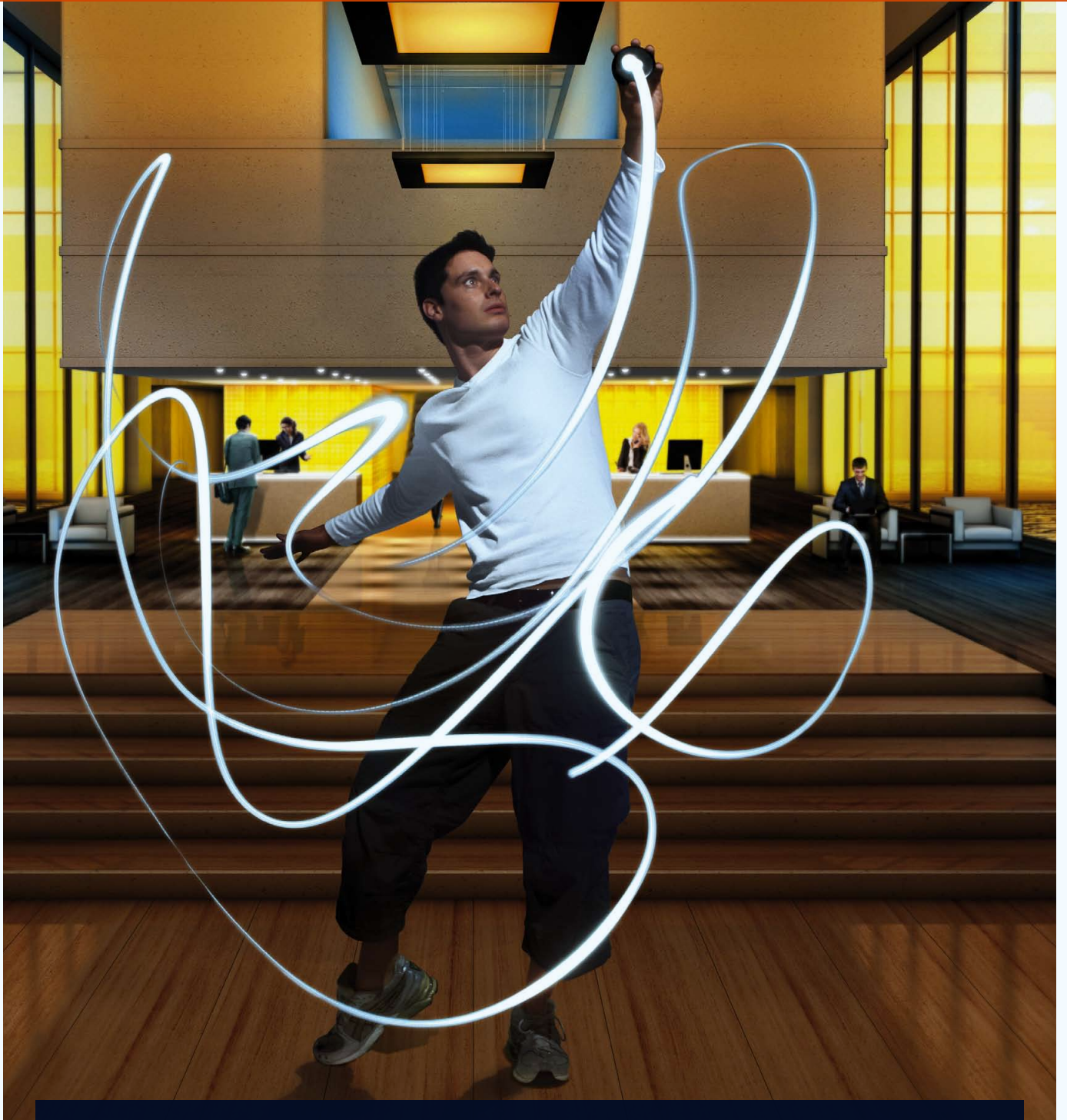

LEDs for General Lighting Solutions

OSRAM Opto Semiconductors empowers lighting solutions for today and tomorrow

OSRAM
Opto Semiconductors

Event Reports

LED FORUM MOSCOW 2009 & INTERLIGHT MOSCOW

> A. Grabher-Meyer, LED professional

The 15th International Trade Fair for Lighting, Light Technology and Intelligent Building Technology drew to a close with plenty of optimism and an outstanding atmosphere. 305 exhibitors and 20,224 industry visitors who enjoyed excellent contacts and promising discussions are looking to the future with great confidence. As in 2008, the extensive supporting program at INTERLIGHT MOSCOW proved a major attraction. Around 300 attending experts considered the LED FORUM MOSCOW, which was held in parallel, a great success.

Highly Popular 3rd LED FORUM MOSCOW

After its great success in 2008, the LED FORUM MOSCOW 2009 was bigger and better. Positive feedback even before the event confirmed the importance of LED technology for the Russian industry.

Registration for the LED FORUM MOSCOW had to be closed several weeks before the start of the conference. The LED FORUM MOSCOW was divided into plenary lectures and workshops this year. Around 220 participants obtained information on current developments and LED technology standards in the plenary lectures on the first day of the event. After the opening speech by the premium sponsor Osram Opto Semiconductors, where the most recent market figures and future market development of solid state lighting industry (SSL) were presented, renowned Russian scientists and international companies talked about state-of-the-art technology.

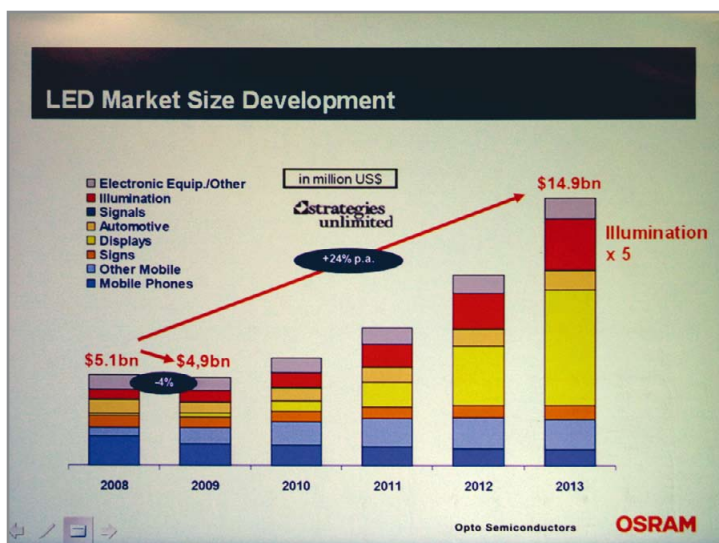

Figure 1: LED market forecast (Osram).

For most participants, the contributions of Russian scientists were the highlights of the opening session. These speeches offered a deep insight into the status of the LED lighting technology in Russia.

The team of Prof. Ustinov from the Ioffe Physical Technical Institute of St. Petersburg reported advances in the development of monolithic RGB LED production and the advantages of a QD based technology for green LEDs and hence white light generation.

Alexey Kovsh, representing OptoGan, a company specialised in GaN/ sapphire epilayer technology, showed appropriate methods to improve quantum efficiency, to reduce droop-losses and degradation at higher currents.

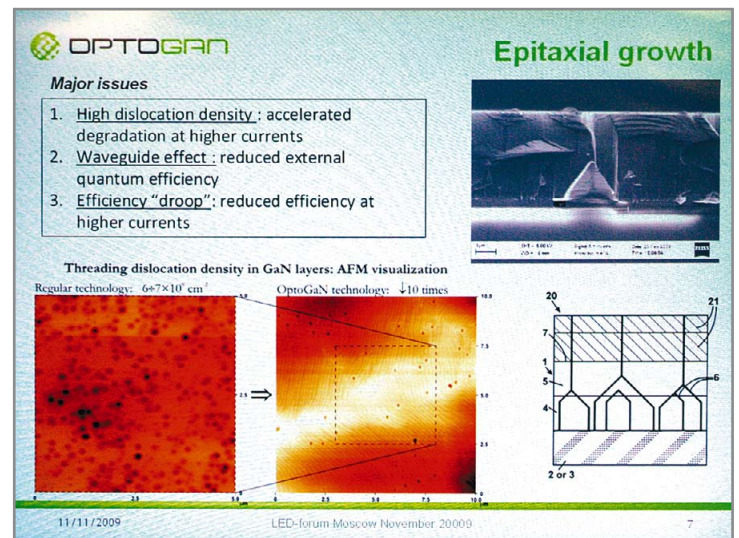

Figure 2: Quality issues of GaN layers (OptoGan).

The report on a pilot project of OAO-Russian Railway Cooperation held by Prof. Rosenberg clearly showed the interest in Russia to improve energy efficiency, although not concealing that due to the cost hurdle, LED products are seen not to be a standard product before 2016.

The specialists of Alanod, Cree, Nichia, Philips Lighting Russia, Philips Lumileds, Polymer Optics and Seoul Semiconductors offered an insight to future development and the effort of component manufacturers to support the luminary manufacturers with better understandable information and better, easier to handle and more reliable products for LED lighting equipment.

While Mitch Sayers from Cree focussed on a consumer friendly reduction of bins and offered solutions with their lighting grade Xlamp-XPE products and presumably in Q1/2010 with a new product, Philips Lumileds speaker, Eric Senders, showed the research results on lifetime reliability and strongly recommends extrapolating test results not more than six times the test time.

Hiroki Oguro from Nichia explained the correlation from efficacy, colour temperature (CCT), and colour rendering index (CRI) - the theoretical limits of different technologies and typical spectral distributions of low CRI, good CRI and high CRI products were demonstrated.

Alanod speaker Knut Seelig presented a new reflector material, especially suitable for LED products and advantages for using reflector systems for some SSL applications instead of lenses. On the other hand Mike Hanney from Polymer Optics explained the difference between cheap, poorly designed lenses using low cost materials - sacrificing efficiency and light quality - and dedicated high end optics.

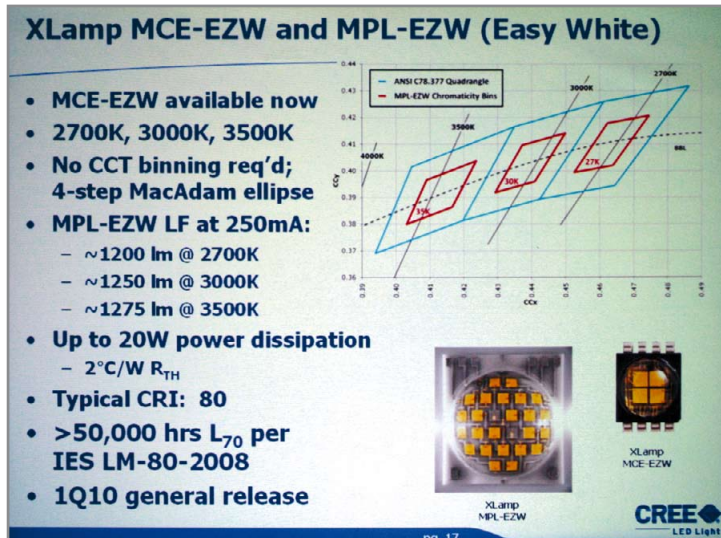

Figure 3: Reduced binning is more convenient for luminary manufacturers (new product announced: XLamp MPL-EZW).

Three parallel workshops were held on day two of the LED FORUM MOSCOW. Simone Mariotto, the Milan lighting designer of Liteq Design, offered information on current developments and fundamental principles for the use of LEDs in shop lighting during the workshop "Shop Lighting with LEDs". The workshop was sponsored by iGuzzini, a leading provider of high-end indoor and outdoor lamps.



Figure 4: Simone Mariotto proved the ability of LEDs for shop lighting years ago by clearly analyzing the demands and carefully selecting the appropriate design and product for a qualified application.

The second workshop "Interior and Exterior Lighting with LEDs" was moderated and conducted by Osram Opto Semiconductors, premium sponsor of the LED FORUM MOSCOW. Claudia Dippold, Dieter Soukup and Leonid Moiseev offered insights into current products from Osram Opto Semiconductors along with their applications.

"Lighting Control Systems and LEDs" was the topic of the third workshop sponsored by the German company Insta Elektro GmbH. Simon Osipov, light planner at Insta, informed workshop participants about energy-saving options through the implementation of lighting control systems with LEDs.

Supporting Program of the INTERLIGHT MOSCOW

"Outdoor and Street Lighting", "Lighting Control Systems", "Problems of the abolition of incandescent lamps and the introduction of energy saving lamps" and "Architecture and Lighting Concepts" proved attractive to many industry visitors as the highlights of the INTERLIGHT supporting program. The visitors informed themselves about new industry developments and insights in the many recantations.

"Outdoor and Street Lighting" conference by RosGorSvet

The Russian government association for outdoor and municipal lighting RosGorSvet held its annual conference in 2009 as part of INTERLIGHT MOSCOW. Municipal representatives from the Russian regions and Moscow presented projects and concepts to reduce energy consumption and improve energy efficiency in the field of municipal and street lighting at the conference.

Lectures on "Lighting Control Systems"

Rising electricity prices and increasing demands on complex lighting applications in major construction projects have led to increasing interest in lighting control systems in Russia. As a result, this was selected as one of the focal points of the INTERLIGHT MOSCOW 2009 supporting programme. In presentations by Gira, Legrand Corporation, Lutron, Osram, Thorn Lighting and Vossloh-Schwabe, interested participants learned about insights in the field of lighting control and familiarised themselves with new products.

Conference "Russia: Problems of the abolition of incandescent lamps and the introduction of energy saving lamps"

Awareness of the need to protect the environment is also increasing steadily in Russia. Just like the European Union, the Russian government is planning a law to eliminate the filament bulb. And so the Russian lighting industry is preparing for the nation-wide introduction of the fluorescent bulb. Russian and international industry representatives provided information and discussed the changes, associated problems and possible solutions during the conference at INTERLIGHT MOSCOW.

Lectures on "Architecture and Lighting Concepts"

Lighting and the correct use of light is becoming increasingly important in architecture. This is why Russian architects and engineers showed great interest in the architectural lighting concepts represented at INTERLIGHT MOSCOW. International lighting designers and experts spoke on this topic. They included Martin Lupton, President of PLDA (Professional Lighting Designers Association), Karsten Winkels of Winkels & Partner, Torsten Henze from LIH Light Impex Henze and Knut Seelig from Alanod.

Workshop "Lighting Concepts for Halls and Façades"

Paolo Spotti, Italian lighting designer from Ferrara Palladino, offered information on the possible implementation of lighting in halls and on façades. How do I properly light a cathedral? How do I illuminate a romantic façade with indirect light? How do I prevent light pollution? Paolo Spotti provided answers to these questions in his workshop with products from the Italian company Futuroluce.

Round Table Talk at INTERLIGHT MOSCOW

The Russian lighting trade association CTA once again met with the representatives of international companies for a Round Table Talk at INTERLIGHT MOSCOW in 2009. The participants discussed the role of distributors and strategic options during the recession.

VNISI 2009 Lighting Design Contest



Figure 5: Presentation of the VNISI 2009 Lighting Design Contest finalists and projects.

As in 2008, the Russian light research institute VNISI hosted the finals of its annual lighting design contest at INTERLIGHT MOSCOW. The supporting programme concluded with the annual conference of young light engineers by Prof. Dr. Artem E. Ataev, member of the Academy of Electrical Engineering.

Industry Visitors from all over Russia

20,224 industry visitors from all over Russia attended INTERLIGHT MOSCOW 2009 in the Russian capital. An increase of 11 % over 2008! The industry visitors came to INTERLIGHT MOSCOW from 44 countries. 32% of the industry visitors travelled to the trade fair from the Russian regions.

According to the results of the official survey, around 97 % of industry visitors were satisfied or very satisfied with their visit to the trade fair and said their expectations had been met. INTERLIGHT MOSCOW is important or very important to 94 % of trade fair visitors and more than 88 % of visitors in 2009 had attended before.

In addition to information about novelties and innovations, 67 % of industry visitors attended the trade fair to establish new business contacts.

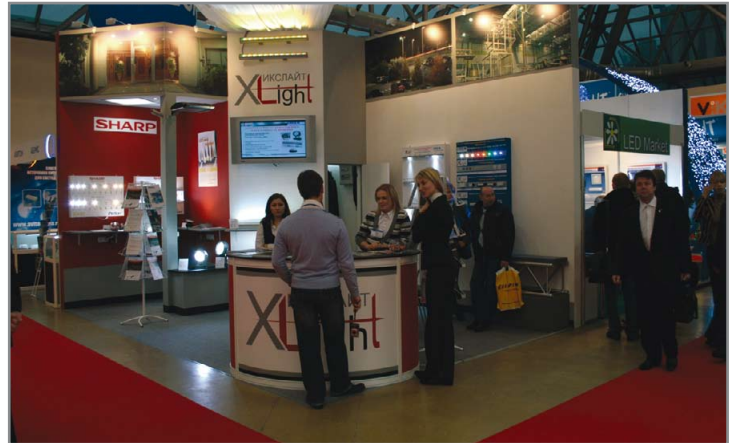

Figure: 6 86 % of industry visitors wanted to obtain information about innovations and market novelties.

Satisfied Exhibitors

305 exhibitors from 21 countries presented their products to the mainly Russian audience in 2009. The exhibitors viewed their attendance at the trade fair as very positive and praised the high number and quality of industry visitors in particular.

The importance of the Russian market was once again underscored by the level of international participation this year: 51 % of all exhibitors came from abroad. The national pavilions presented by Asia (65 participating companies), Germany (18 exhibitors), Spain (16 exhibitors) and Turkey (22 exhibitors) also confirm the position of INTERLIGHT MOSCOW as the leading international trade fair for the industry in Russia and the CIS states.

Renowned companies presented themselves at INTERLIGHT MOSCOW with attractive booths. Alanod, Amira, Boss Lighting Group, Eclo-Leuchten, EMME Pi Light, Fael Luce, Kolarz, Lighting Technology, Mabelek, Moslezard, Nichia, Search Light, Seoul Semiconductor, Technolight and Trilight were among those present. ■



High Thermally Conductive Materials

DENKA THERMALLY CONDUCTIVE SHEET is a thermal interface material, containing high thermally conductive ceramics filler. This product shows a good electrical insulation also.

DENKA THERMALLY CONDUCTIVE SPACER which can fill the gap in components is also available.



Head Office
Nihonbashi Mitsui Tower,
2-1-1, Nihonbashi-Muromachi,
Chuo-ku, Tokyo 103-8338,
JAPAN
TEL: 81(3)5290-5542
FAX: 81(3)5290-5289
Mail: dk010282@denka.co.jp



Taiwan International TILS Lighting Show

台灣國際照明科技展



March 12-15, 2010

Taipei World Trade Center Exhibition Hall

www.TILS.com.tw

Sponsor:



Bureau of Foreign Trade, MOEA

Organizers:



TAITRA

www.taipeitradeshows.com.tw



TLFEA

www.lighting.org.tw

Thermal Management

Thermally Activated Degradation of Phosphor-Converted White LEDs

> L. Trevisanello, M. Meneghini, Dept. of Information Engineering, University of Padova

The increasing performances and long lifetime of High Brightness LEDs are still limited by the high temperatures involved. This work shows the results of several accelerated lifetime tests on 1W white LEDs. Two different tests have been carried out: a pure thermal storage at different temperatures and an electrical aging obtained by biasing the LEDs. The impact of high temperatures has been evaluated in terms of flux decay, chromatic properties modification, increase of forward voltage and thermal resistance. A picture of the main degradation mechanisms detected has been provided in detail.

Introduction

Over the last years, the development of Gallium Nitride-based optoelectronic devices covering a wide spectral region from green to ultra-violet has determined a revolution in the lighting industry: thanks to the introduction of high performance device structures (efficacy values above 130 lm/W, [1]), GaN LED technology is targeted to replace the traditional light sources or general lighting, including the light bulbs, with enormous energy savings and environmental benefit.

The environmental advantages of adopting LEDs for general illumination can be easily understood: assuming a 100% market penetration of LED lighting and a 50% conversion efficiency, in the year 2025 the projected electric savings in the U.S. would be roughly 525 TW-h/year (or 35 B\$/year), and the savings in carbon dioxide equivalent emissions would be approximately 87 Mtons.

Furthermore, LED illumination technology eliminates the hazardous-waste issues associated with mercury-containing fluorescent tubes. For this reason, GaN-based LED market is expected to see a rapid growth in the next three years, due to the possibility of adopting these devices for the realization of high-efficiency light sources.

Despite all the improvements that this technology is achieving [2], the main issue of power LED devices is still represented by thermal management. The high junction temperature reached during operation limits the life time of devices and better performing heat sinks are needed in order to operate at high current level. While a few authors reported results for long term stress of AlGaInP LEDs [3], life analysis for normal operating conditions has never been performed on GaN LEDs. Several works reported the impact of high temperature and high current condition on reliability [4-7]. However, a clear picture of the different impact of the current and the temperature on the LED lifetime has never been described.

This paper wants to give a picture of the different degradation mechanisms activated by high temperatures and bias on a family of 1W phosphor-converted LEDs. In particular, several devices have been submitted to an initial characterization in terms of optical, electrical and thermal properties. These properties have been monitored during thermal stress and exhibited a strong degradation. In order to compare results of thermal storage to normal operation condition, an accelerated electrical ageing was performed.

Although the temperatures involved in this work are higher than the maximum ratings specified by the manufacturer, and the devices used belong to an old technology in terms of materials and design, the reader must focus the attention to the importance of adopting smart thermal management solutions in the development of Solid State Lighting applications.

The research activity was carried out in the laboratories of the Microelectronics Group of the University of Padova, Italy. The laboratories are equipped with all the instrumentation of the analysis of the thermal, optical and electrical characteristics of visible LEDs, and for the execution of ageing tests under different bias and environmental conditions. The group has a specific know-how on the analysis of the physical mechanisms that limit the performance and the reliability of electronic devices, and on the definition of models for the explanation of the failure modes and for the extrapolation of the long-term degradation kinetics in electronic devices.

Experimental Setup

The devices used in this work are 1W Phosphor-Covered white LEDs. The structure of devices is composed of 1 mm² area InGaN/GaN LED attached to a copper frame that operates as heat sink. YAG phosphors for yellow conversion are distributed in the protective epoxy that covers the chip. Since the standard deviation of optical and electrical characteristics was below 1% before stress, 5 devices per stress condition have been used in order to have relevant results representative of a larger number of devices.

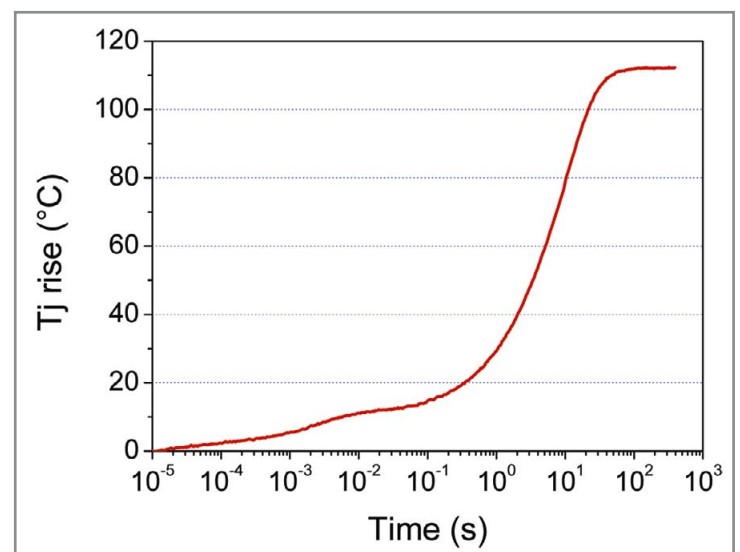

Figure 1: Junction Temperature rise of a LED biased at 400mA.

The main goal of this work is to compare the different degradation mechanisms of devices submitted to pure thermal ageing and dc current ageing. In order to analyze these mechanisms, several characterization techniques have been used. Before ageing the devices, a complete optical characterization has been performed. These measurements were repeated at exponential time steps removing devices from the ageing setup. Furthermore, a thermal analysis was carried out before and after the ageing in order to estimate the junction temperature during stress and the differences in thermal resistance between untreated and aged devices. Light output versus current (L-I) measurements were performed at room temperature by means of an optical power meter equipped with a 2 inch integrating sphere. During the measurements LEDs were biased with a programmable current source able to generate short current pulses, in order to avoid the device self heating. In particular, the devices have been biased and measured with short width pulses (80µs) measurements with a 1s period. Finally, EL spectra were collected by means of a spectroradiometer.

After first selection of devices, parameters for stress conditions were determined. For thermal stress, a climatic chamber at temperatures of 180, 200, 220, and 230°C has been used, with unbiased devices in order to separate degradation mechanisms induced by carrier flow. Although the temperature levels were quite high (the maximal temperature of the junction suggested by the manufacturer is 125°C), the stress conditions chosen could guarantee faster kinetics and, on the other hand, acceleration factors useful to extrapolate life time in nominal operation conditions.

DC current stress has been setup in order to compare the degradation mechanisms generated by different stress conditions. The accelerated stress has been obtained by driving the devices at a current level slightly higher than the nominal one (400 mA instead 350 mA, about 14% above nominal) and without the heat-sink. The evaluation of the junction temperature during stress is very important in order to understand the impact of thermally activated degradation mechanisms. For an accurate estimation of the temperature we used electrical characterization based on forward voltage technique, well described by several authors [9]. The technique consists in a preliminary pulsed mapping of voltage at several temperatures and current levels in order to estimate the parameter. Afterwards the devices were biased at fixed current and once the voltage transient has been collected, the thermal transient has been extrapolated. In figure 1 the thermal transient of one device driven at 400 mA have been reported. As can be noticed, the steady state junction temperature of the device operated at RT was approximately 140°C (115°C+25°C ambient). This fact implies a junction temperature higher than the maximal temperature suggested by the manufacturer, but still lower than temperature level of thermal storage.

Results and Discussion

In the following sections results from both thermal and current ageing have been reported in order to compare the degradation mechanisms owing to different stress conditions.



Universal Portable Light Meter

Jaz does it all!!

- Lumen
- Lux
- PAR
- CRI
- CIE
- CCT



UK: +44 1865 263 180
 Germany North: +49 513 697 467 05
 Germany South: +49 711 341 696 0
 France: +33 148 576 136
 Austria: +43 226 220 673
 Other: +31 26 3190500

www.oceanoptics.eu

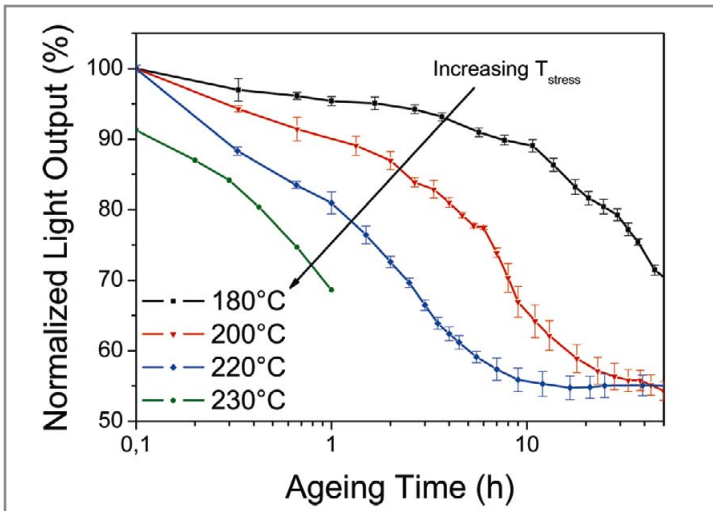

Figure 2: Flux decay at different storage temperatures.

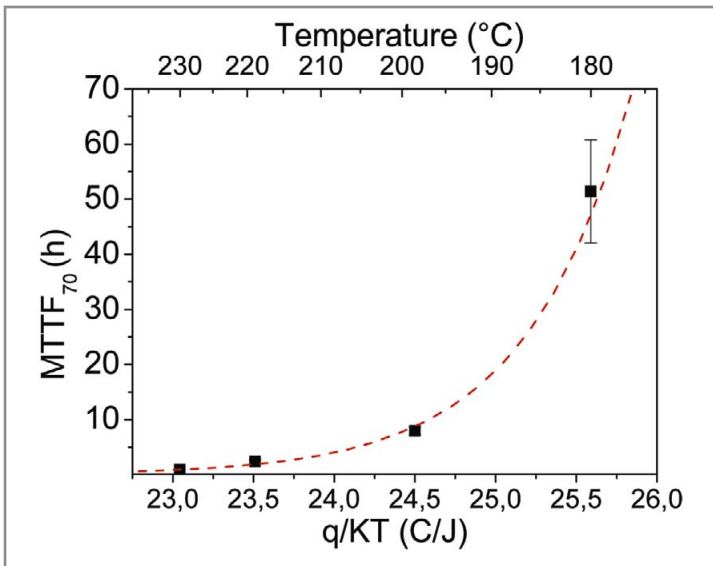

Figure 3: Average values of the Time To Failure for a 30% flux decay. The red line represents the exponential fitting, according to equation (1).

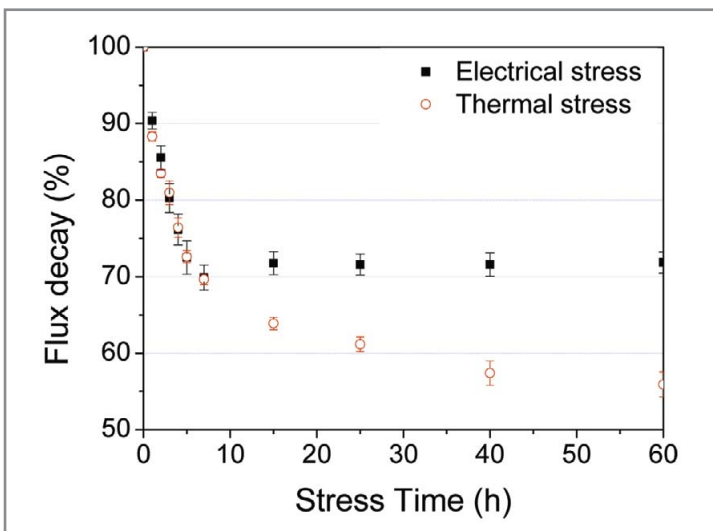

Figure 4: Flux decay for LEDs submitted to thermal storage at 220°C (red dots), and aged by dc bias at 400mA (black squares).

Light output characterization

Thermal ageing induced a strong optical power lowering, as can be noticed in figure 2, where light output measured at a fixed current of 100 mA (normalized to initial value) has been reported. A nearly exponential decay kinetic has been detected: moreover, the time constant of the degradation process decreased with increasing of the ageing temperature. The plot reported in the figure shows the average of several aged samples: the low values of the error bars confirm that the number of samples used for this work is sufficient for a statistically relevant analysis. In order to clarify the trend of degradation process, we used the time to reach the 70% of light output as the failure parameter (MTTF_{70%}) and we plotted data in figure 3. As can be noticed, the degradation law exhibits an exponential behavior, represented by equation (1):

$$MTTF_{70\%} = A \cdot e^{\frac{E_a}{kT}} \quad (1)$$

where k is the Boltzmann constant, T the temperature of storage, and E_a the activation energy of the process that was found to be 1.5 ± 0.1 eV. The extrapolated activation energy was similar to the results of previous works [5]. The developer of the SSL application must be aware that the degradation mechanism found is related to the temperature range between 230°C and 180°C. This means that with $T_j < 180^\circ\text{C}$ a different activation energy may be found, of course with a lower activation energy. However, the analysis may take a lot of time since the acceleration factor of the stress will be lower.

Similar decay kinetics were detected during accelerated current stress. In figure 4 the average of optical power measured at 100 mA during ageing and normalized to initial value has been reported. The decay induced by current stress was compared to the plot of light output during thermal storage at 220°C. Although the junction temperature during bias ageing was lower than 220°C, the decays were well correlated until 10 hours, implying that the degradation process induced by current ageing cannot be ascribed only to the high temperatures involved during stress. In addition, the plot reports that the light output of devices aged at 400 mA stabilizes after first 10 hours of ageing, while the 220°C aged devices' efficiency follows the initial exponential decay. For considerations on degradation mechanism acting on lighting decay, further analysis have to be carried out on spectral and package properties, as follows in the next sections.

Spectral analysis

Electroluminescence spectra has been collected before and during thermal stress. In figure 5 one can notice the standard spectrum of Phosphor-Converted white LED, with a blue (InGaN LED) and yellow peak (YAG phosphors). The thermal ageing induced a modification in spectral shape in terms of yellow efficiency. From absolute measurements the lowering of both peaks have been detected.

guangzhou international lighting exhibition

广州国际照明展览会

The biggest lighting industry forum in Asia

9 – 12 June 2010

China Import and Export Fair Pazhou Complex
Guangzhou, China

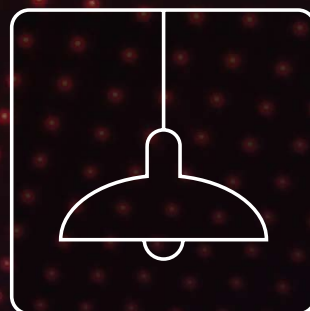
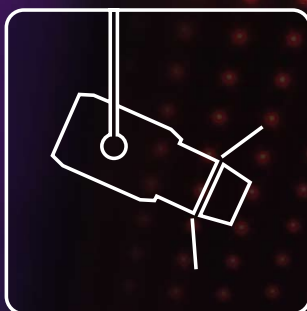
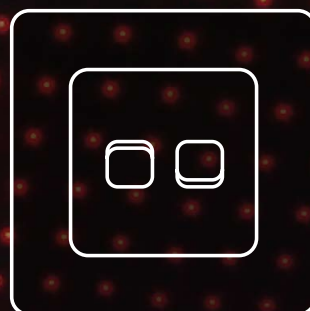
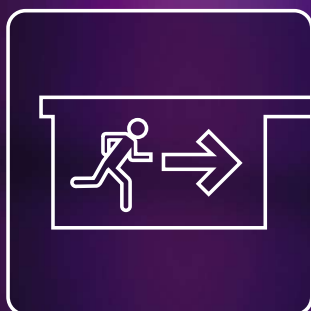
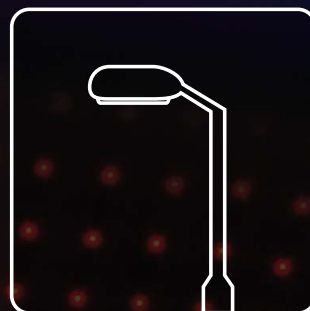

For more information, please contact:

Tel: (852) 2238 9937

Fax: (852) 2598 8771

LBguangzhou@hongkong.messefrankfurt.com

www.light.messefrankfurt.com.cn



messe frankfurt

However the degradation of yellow emission was more enhanced than the blue one and the chromatic yield of device worsened. In order to quantify the spectral modification, the chromatic coordinates X, Y CIE 1931 have been reported in the chromatic diagram in figure 6. As can be noticed, the thermal treatment induced a strong degradation in terms of white yield. In order to understand the level of degradation, the 4-step MacAdam ellipse has been reported for comparison. As widely known, the human eye cannot notice any difference in the colours inside the MacAdam ellipse. This means that after few hours of ageing, a modification of the colour can be noticed. This implies two consequences: (i) after the ageing the colour will not be white anymore and (ii) if two light sources are present in the room and one degrade with higher rate, the colour difference will be detected, and the room will be illuminated by an odd light.

The light output tends to become bluish after ageing and the degradation was observed under all the stress conditions adopted within this work. Considering the ratio between spectral intensity at 560 nm and 456 nm as a degradation parameter, we found that the kinetic followed an exponential decay law, well correlated with the overall light output decay. Thus, the main degradation progress involved in light output decay could be ascribed to yellow conversion of blue light, together with a less predominant lowering of blue emission. This lowering could be ascribed to several mechanisms, i.e. the interaction with hydrogen and the consequent p-dopant passivation, as recently reported in [10]. Concerning the worsening of yellow conversion efficiency, several suggestions on degradation mechanisms could be inferred: (a) the lowering of phosphors efficiency, (b) the browning of the lens, and (c) the degradation of the package [11]. Several authors reported that YAG phosphors employed in LEDs exhibit high stability during operations [4]. The package analysis reported afterwards could provide explanations for the spectral shape modifications.

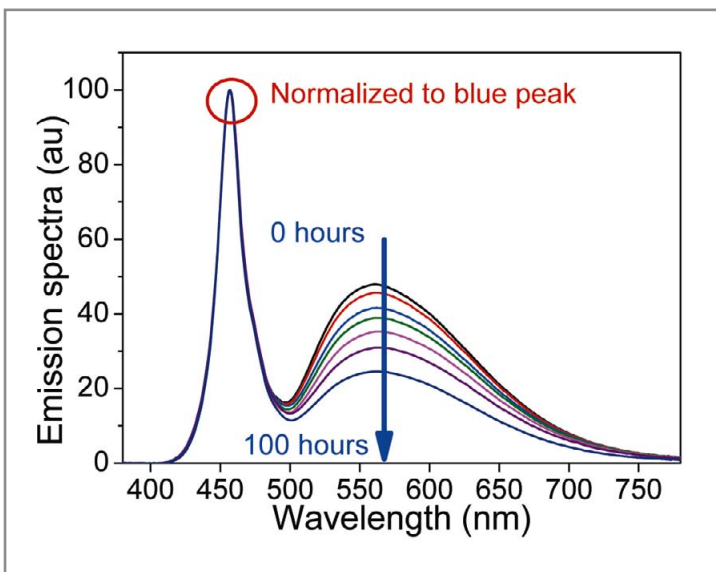

Figure 5: Emission spectra of LEDs submitted to the thermal storage. The spectra have been normalized to the blue peak, in order to underline the lowering of the yellow peak with respect to the blue one.

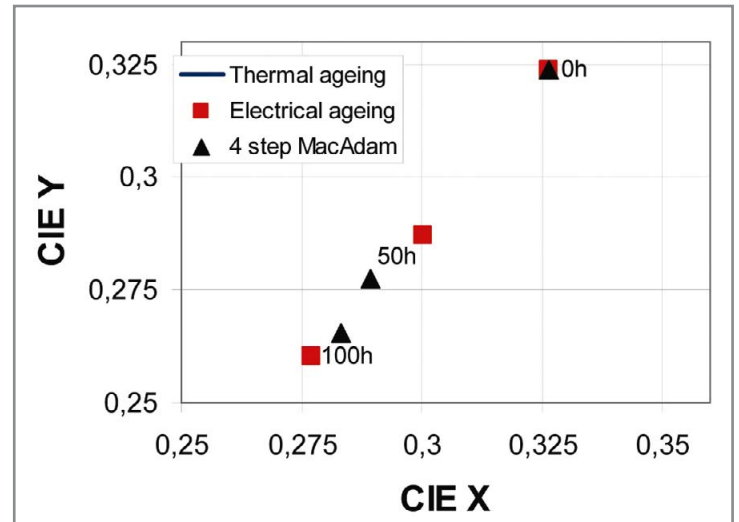

Figure 6: Degradation of the chromatic coordinates of the aged devices (thermal storage and dc bias stress). The 4-step MacAdam ellipse centered at initial coordinates has been included.

Electrical characterization

During thermal and dc current ageing, electrical properties of devices were monitored by means of I-V measurements. The main contribution to the modifications has been detected in the high current range ($I > 1$ mA) in terms of series resistance increase. The kinetics of voltage measured at a fixed current of 400 mA for representative devices has been reported in figure 7.

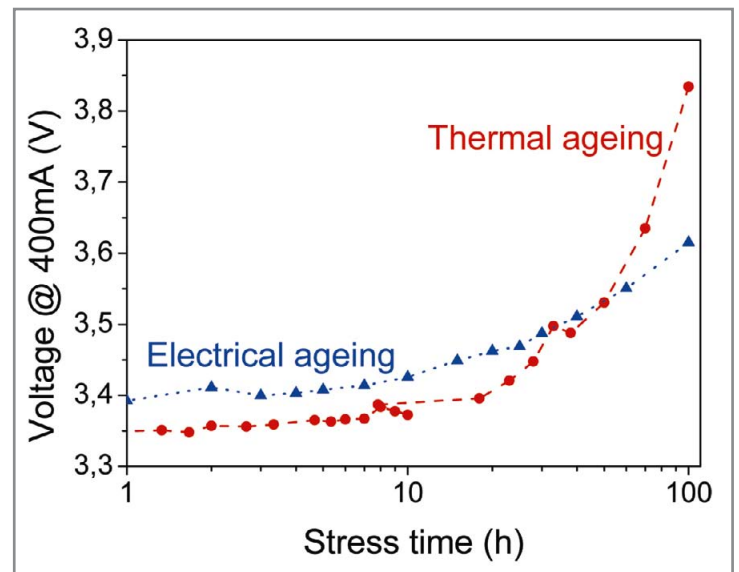

Figure 7: Forward voltage increase during thermal storage (red) and electrical ageing (blue), measured at a constant current of 400mA.

As can be noticed in the figure, stress induced different kinetics for different stress conditions. Whereas for dc current stress the voltage followed a square root time law, the behaviour for high temperature

aged devices was exponential and more enhanced for higher temperatures. Nevertheless, the general trend was very different from exponential decay of light output (figure 4). This uncorrelated behaviour suggest that two different degradation mechanism are responsible for the change in the electrical and optical parameters. For instance, the electrical properties worsening of the contacts in terms of rectifying behavior [12] or detachment from the semiconductor [6]. Since the degradation process that induced the series resistance increase could be ascribed to the structure of the device, a package analysis has been carried out.

Package analysis

The devices submitted to accelerated life testing showed a visible consequence of the stress in terms of package appearance. After several hours of ageing, the package showed a browning of the white plastic material around the chip. The browning occurred in different patterns. For thermal stress, the package darkened uniformly; on the other hand, the electrical aged devices showed a more enhanced browning at the anode side. In figure 8 the cross sections of aged device has been reported, together with the optical microscope images of the devices submitted to thermal and electrical stress. The different browning pattern detected on the top of the LEDs could be easily understood considering the package design visible in the cross section. The anode is in electrical and thermal contact with the copper frame just below the die attach. This metal mass is the heat sink of the device, and during operating conditions the frame is subjected to high temperature levels. Thus, the plastic around the contact degrades faster than the other side.

The aforementioned worsening of optical properties in terms of light output and spectral properties could be related to the observed carbonization of the package. While the stress affected the white plastic of the package around the copper frame, the reflection properties in the middle remained unchanged. On the other hand, the stress induced a strong decrease in emission in the area around the chip. The light in this region is generated by reflection from side emission of the chip. The browning of the package affected the reflection properties and the lateral blue emission is not enough to excite. To support this hypothesis, the different kinetics of optical power decay in figure 4 could be ascribed to the distinct carbonization pattern in figure 8.

The detrimental effects of ageing tests could be ascribed to materials employed for packaging. The materials used for these old generation devices, like the epoxy containing the phosphors or the white nylon composing the package, exhibit a strong sensitivity to high temperature levels. Currently, LED manufacturers are now using more robust materials (like silicon for the lens) and smart package design (phosphors deposited directly on the chip, ceramic package that act as heat carrier and electrical insulator). However, the strong impact of the temperature on the LEDs lifetime must be considered when designing the thermal management of the application.

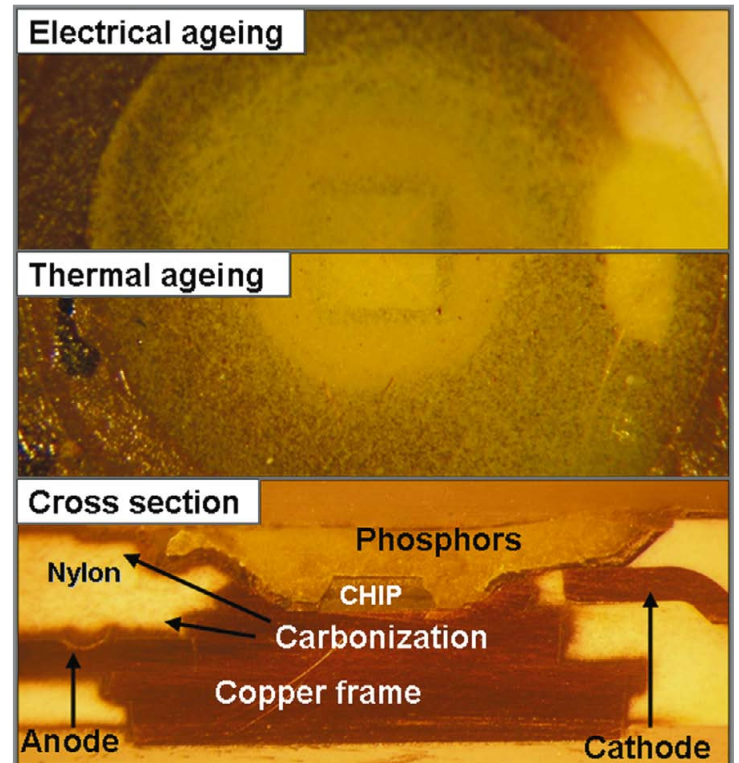

Figure 8: Optical images of electrical aged device (top), thermal aged device (center), and the cross section of the electrical aged device, along cathode-anode direction.

Thermal analysis

The thermal transients collected before and during ageing could give more information on degradation mechanisms described before. In particular, transients have been elaborated using the structure functions theory in order to extrapolate thermal impedance and other information on the thermal properties of devices. Since the structure of devices analyzed is vertical, we can approximate a uni-dimensional heat flow path from the junction to the copper frame. Thanks to this approximation, the deconvolution of the thermal transient with a weighting function could be performed in order to extrapolate the time constant spectrum. This spectrum represents the lumped-element Foster model for thermal impedance. The Foster model has to be transformed in Cauer network in order to give a physical meaning to the model. Finally, this model can be used to represent the cumulative structure function C_{th} (heat capacitance per unit length), and the differential structure function K . In particular, this function can be written as

$$K = \Delta C_{th} / \Delta R_{th} = c \lambda A^2, \quad (2)$$

where c is the heat capacitance, λ the heat conductivity and A the cross section area of the heat flow. The two structure functions are plotted using cumulative thermal resistance (K/W) as x-axis [13].

In figure 9 we have plotted the evaluated cumulative and differential structure functions for one representative untreated device and one device aged at 400 mA for 50 hours. From this figure we can extrapolate various information. First, each peak corresponds to a interface or a

variation in cross section area along heat-flow path. Thus, the solid line in figure 9 shows two visible peaks at 3.5 K/W and 10 K/W. The first one represents the thermal resistance from junction to chip, while the second is the thermal resistance between junction and the copper frame of the package. The total amount of thermal resistance between junction and ambient is given by vertical asymptote, where the structure function goes to infinite, and is equivalent to 87 K/W (not shown in the figure). This thermal resistance value is so high due to low thermal conductivity of the small copper frame to the ambient. For comparison, we reported in the plot the differential structure functions of aged device. We noticed that the main variations in behaviour were concentrated in the region near the junction, that in the figure corresponds to the region where thermal resistance is below 20 K/W. While the peak corresponding to junction-chip thermal resistance remained almost unchanged for aged device, the peak corresponding to copper case slightly moved towards higher K resistance values for aged devices at about 17 K/W. This difference could be related to the worsening of the contact properties during ageing. As reported by [14], stress can induce a partial detachment of contact layer from chip. Contacts play a relevant role in heat dissipation and poor adhesion of metal layer could induce a decrease of thermal conductivity of the device. This hypothesis is in agreement with results on I-V characterization: detachment of contact layer may contribute to series resistance increase.

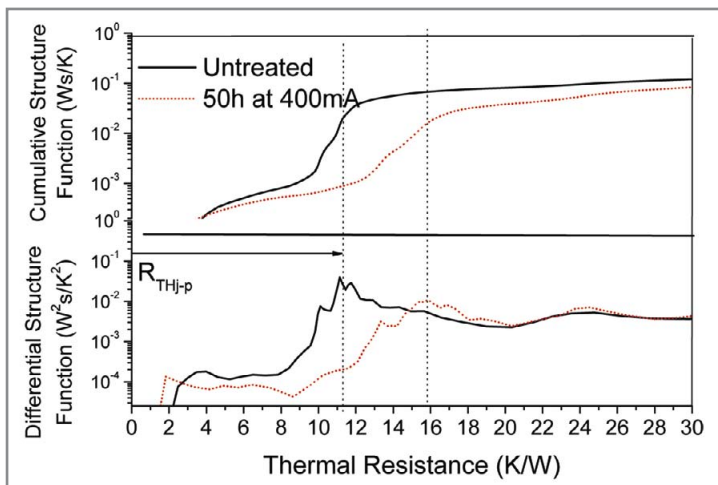

Figure 9: Cumulative and differential structure functions of untreated (solid line) and aged devices (dots). The shift of the peak related to thermal resistance between junction and package is clearly visible.

Conclusions

A wide set of white LEDs has been submitted to accelerated life test in order to compare degradation mechanisms and find degradation behaviour and acceleration factors. The life test consisted of high temperature storage and high current biasing. The different stress conditions induced similar degradation mechanism in terms of (a) light output decay, (b) spectral properties modifications, and (c) package epoxy browning. Exponential kinetics of the MTTF70% for thermal aged devices has been detected for high temperature levels. The optical

decay could be ascribed to a lowering of blue chip emission and a degradation of yellow conversion efficiency. Concerning blue chip degradation, further work on the bare chip is planned, whereas the worsening of yellow emission has been ascribed to the browning of the package epoxy, suggesting to the manufacturers to use different silicon materials for packaging. Furthermore, an increase of (d) forward voltage, and (e) thermal resistance was detected. The rise in series resistance can be ascribed to chip level degradation, i.e. contact properties worsening or contact detachment. On the other hand, the modifications of thermal properties of the materials (die attach, epoxy) could induce the thermal resistance increase detected for aged devices. The use of silicone materials rather than epoxy plastic for package will improve the lumen maintenance of such devices. ■

Acknowledgments:

Prof. Enrico Zanoni and Prof. Gaudenzio Meneghesso of the Dept. of Information Engineer, University of Padova, for the fruitful discussion on the device reliability.

References:

- [1] S. P. DenBaars et al., "Recent advances in High Brightness GaN based LEDs," *Proceedings of the International conference on Display LEDs ICDL2007*, pp. 66–70, Feb. 2007.
- [2] Michael R. Krames, Oleg B. Shchekin, Regina Mueller-Mach, Gerd O. Mueller, Ling Zhou, Gerard Harbers, and M. George Craford, "Status and Future of High-Power Light-Emitting Diodes for Solid-State Lighting," *J. Display Tech.*, vol. 3, no. 2, Jun. 2007.
- [3] Patrick N. Grillot, Michael R. Krames, Hanmin Zhao, and Seng Hup Teoh, "Sixty Thousand Hour Light Output Reliability of AlGaInP Light Emitting Diodes," vol. 6, no. 4, Dec. 2006.
- [4] N. Narendran, Y. Gu, J. P. Freyssonier, H. Yu, and L. Deng, "Solid-state lighting: failure analysis of white LEDs," *Jour. of Cry. Growth*, vol. 268, no. 3–4, pp. 449–456, 2004.
- [5] S. Ishizaki, H. Kimura, and M. Sugimoto, "Lifetime estimation of high power LEDs," *J. Light & Vis. Env.*, vol. 31, no. 1, pp. 11–18, 2007.
- [6] M. Meneghini, S. Podda, A. Morelli, R. Pintus, L. Trevisanello, G. Meneghesso, M. Vanzì, and E. Zanoni, "High brightness GaN LEDs degradation during dc and pulsed stress," *Microel. Rel.*, vol. 46, no. 9–11, pp. 1720–1724, Nov. 2006.
- [7] G. Meneghesso, S. Levada, R. Pierobon, F. Rampazzo, E. Zanoni, A. Cavallini, A. Castaldini, G. Scamarcio, S. Du, and I. Eliashovich, "Degradation mechanisms of GaN-based LEDs after accelerated DC current ageing," *IEEE Proc. on Intern. Electr. Device Meeting*, 2005, pp. 103–106, Dec. 2005.
- [8] Székely, and T. Van Bien, "Fine structure of heat flow path in semiconductor devices: a measurement and identification method," *Solid-State Elect.* vol. 31, no. 9, pp. 1363–1368, 1988.
- [9] Y. Xi, and E. F. Schubert, *Appl. Phys. Lett.*, vol. 85, pp. 2163, 2004.
- [10] M. Meneghini, L. Trevisanello, U. Zehnder, T. Zahner, U. Strauss, G. Meneghesso, and E. Zanoni, "High-temperature degradation of GaN LEDs related to passivation," *IEEE Trans. Electron Devices*, vol. 53, pp. 2981–2987, Dec. 2006.
- [11] Daniel L. Barton, Marek Osinski, Piotr Perlin, Petr G. Eliseev, and Jinhyun Leeb, "Single-quantum well InGaN green light emitting diode degradation under high electrical stress," *Microel. Rel.*, vol. 39, pp. 1219–1227, Jan. 1999.
- [12] M. Meneghini, L. Trevisanello, U. Zehnder, G. Meneghesso, and E. Zanoni, "Reversible degradation of ohmic contacts on p-GaN for application in high brightness LEDs," *IEEE Trans. Electron Devices*, vol. 54, no. 12, pp. 3245–3251, Dec. 2007.
- [13] Gábor Farkas, Quint van Voorst Vader, András Poppe, and György Bogná, "Thermal Investigation of High Power Optical Devices by Transient Testing," *IEEE Trans. Compon. Packag. Technol.*, vol. 28, no. 1, Mar. 2005.
- [14] Jianzheng Hu, Lianqiao Yang, and Moo Whan Shin "Mechanism and thermal effect of delamination in light-emitting diode packages," *Microel. J.*, vol. 38, pp. 157–163, Oct. 2006.

Photonics Festival in Taiwan



LED Lighting Taiwan

The 6th Int'l LED Lighting Exposition
<http://www.optotaiwan.com>

June 9-11, 2010

Taipei World Trade Center

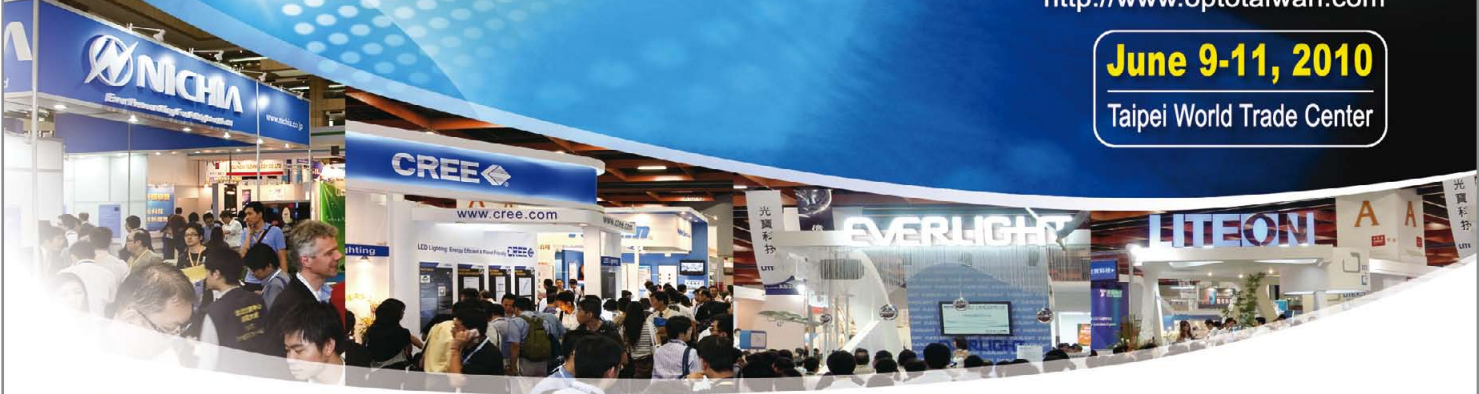

Exhibits

- **LED Lighting Fixture**
for Indoor, Outdoor, Specialty, Solar
for Decorating, Landscape, Architecture, Garden
Control System & Accessories
- **LED Applications**
Automotive Lamps, Backlight,
Display Board, Traffic Signal, IrDA, etc.
- **Package / Module**
Lamp, Digital, Dot Matrix, Cluster, SMD, etc.
- **Epi Wafer, Chip**
- **Materials**
Substrate, Ingot, Phosphor, Epoxy,
Lead Frame, etc.
- **Processing Equipment**
Wafer (MOCVD, Mask, Etching)
Assembly (Dicing, Bonding, Packaging)
Testing (Prober, Aging)

Organizer



Photonics Industry & Technology Development Association

5F, No.9, Roosevelt Road, Sec.2, Taipei 10093, Taiwan
<http://www.pida.org.tw>

Tel : +886-2-2351-4026 Fax : +886-2-2396-8513
Pamela Hsiao (ext. 805) E-mail : exhibit@mail.pida.org.tw
Allen Lee (ext. 850) E-mail : allen@mail.pida.org.tw



MinleonTM

*A Leading Manufacturer & Distributor of Quality Holiday,
Decor & General Use LED replacement Bulbs and String lights*

LED professional

LED Ceiling Panel



www.minleon.com

Minleon International Ltd.
Dongken Town, Dongken City
Guangdong Prov, China 523450
website: www.minleon.com
email: info@minleon.com

Minleon International is a leading manufacturer of high quality LED lighting products. Featured products include retrofit/replacement LED bulbs in the holiday, décor and general use markets. Minleon has an in-house professional design team for tooling, custom plastic molding, SMD and assembly. Minleon has a branch facility in the USA to warehouse product and provide hands-on customer service to its nationwide network of distributors and their customers.

www.minleon.com

LED lamps



www.minleon.com

Minleon International USA Ltd.
3920 Market Street
Camp Hill, PA 17011
Toll-free 866-670-0422
email: minleonusa@live.com

LEDs and Heat: Managed or Micromanaged

> Dan Jacobs, Product Engineer, OPTEK Technology

All of the focus on thermal management of light emitting diodes raises the question: is it always worth the cost? For LEDs, every penny must be applied efficiently. The benefits of lower junction temperature are well known, but there is a tipping point between investing additional product cost in thermal management and getting a return on that investment. Good thermal management starts with clear product and application definition. Mechanical and electrical elements exclusive of thermal management materials may have a strong, unexpected impact on junction temperature. It is often possible to direct added cost to other parts of the product design to accomplish equal reduction in junction temperature while gaining performance in these other areas at the same time. Smart design and sound product development decisions will rightly relegate thermal management materials to secondary status in products. Given a choice, the best place to invest is the LEDs themselves.

Justifying Good Thermal Management

In case one has not heard, reliability is the calling card for LED products. Long life and lumen maintenance depend on junction temperature more than any other factor, thus thermal management indirectly supports the most significant, marketable aspect of this technology. This connection makes it easy to tout the importance of thermal management.

Beyond reliability, LED performance is inextricably linked to junction temperature with efficacy, forward voltage, chromaticity, and product life directly dependent on this characteristic. One has to consider functional changes in LED performance for every 10°C change in junction temperature. Luminous efficacy (lm/W) decreases by 2-5% depending on color. The design must compensate for these losses either by providing more input power – and further straining the thermal performance of the system – or adding more components. Forward voltage decreases by roughly 30 mV. If a linear regulator circuit is on-board with the LEDs to maintain forward current, the regulator must dissipate extra heat from the extra voltage as the LEDs net forward voltage decreases. Its functionality or reliability can be compromised. Wavelength shifts by about 1-2 nm; consequently the color temperatures of white LEDs are impacted as their blue sources change. Chromaticity affects the aesthetics of lighting solutions – if the junction temperatures of LEDs in the same room or area are not consistent throughout, there may be apparent differences in color temperature.

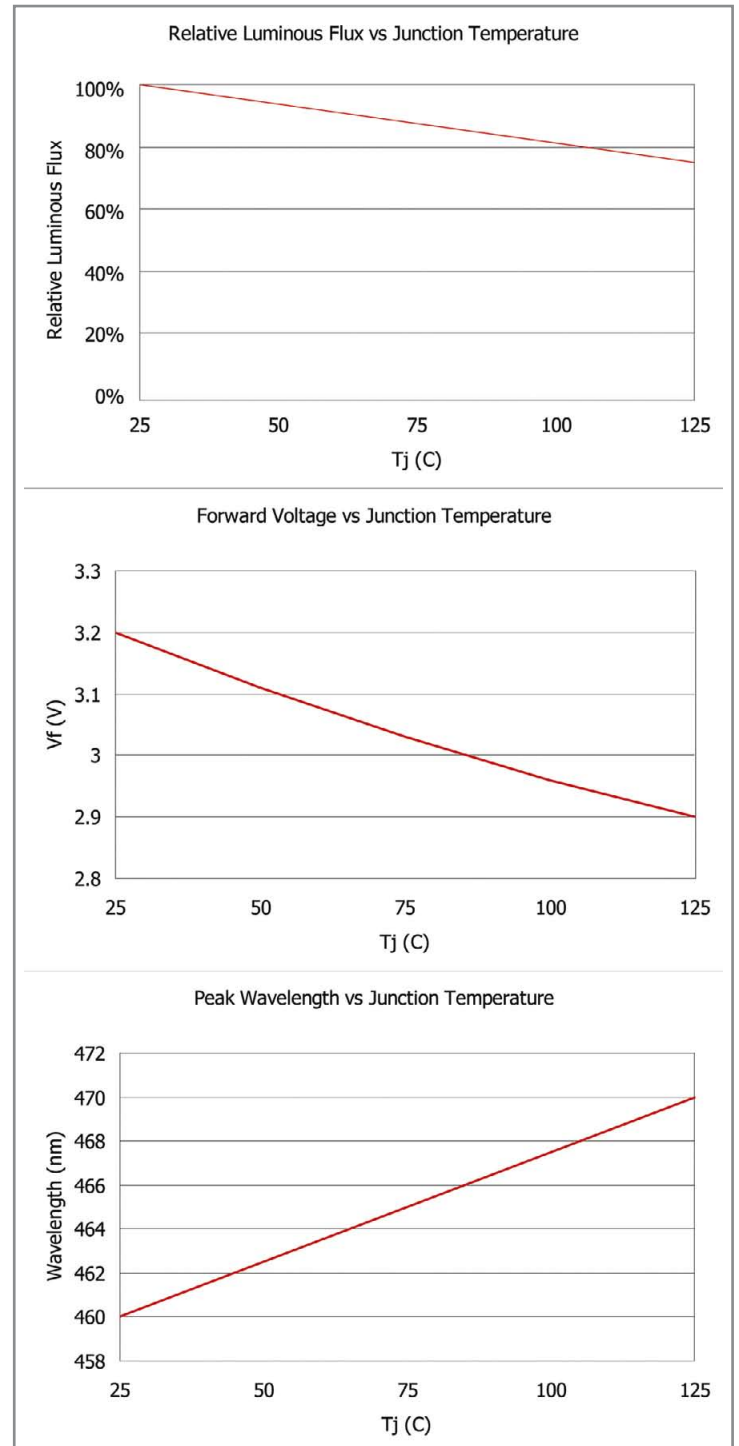

Figure 1: Effects of T_j on LED characteristics.

Application Considerations

Application criteria must be considered before delving into aspects of LED product design intended to reduce junction temperature. Thermal management tends to be handled as a reaction to the rest of the design, but it should be considered from the outset – when the application is first assessed. Environmental conditions need to be suitable for LEDs. Lighting within an enclosed environment will make thermal management difficult to impossible. LEDs in environments

with large temperature changes force designers to add elements that meet the requirements of the extreme worst-case scenario. When conditions are mild, those aspects of the product are extraneous. If high temperatures will be present, common sense should be applied before proceeding with LEDs. Fortunately, LEDs fit some applications particularly well because they produce less heat and operate well in low temperatures. For example, elevator lights tend to heat the cab significantly enough to make the environment uncomfortable for passengers; LEDs in elevator cabs provide a means to dramatically reduce this effect. Another good example is placing light fixtures in places that may be regularly touched by people, particularly in retail stores and at home. Since LEDs produce less heat and operate at low voltages, these applications move from desirable to possible.

To reduce the impact of heat, the way an application need is addressed, has to be rethought. For example, replacing incandescent and compact fluorescent bulbs with LED bulbs doesn't make much sense in some cases. This product path is chosen to shortcut the process of replacing fixtures, but it makes thermal management difficult to impossible. As a result, the LED bulbs are not bright enough for most of the applications requiring bulbs. It is not just the physical constraint of removing heat from the bulb itself; much of the time, bulbs are installed in enclosed spaces such as can lights or in ceiling and wall fixtures. Designing products that rely on the end-user for proper thermal management leaves much to be desired.



Figure 2: LED bulbs: penny-wise, pound-foolish?

New fixtures and lighting expectations may be necessary to best manage and apply LEDs. The conversion to LED lighting will be slower than many hope or claim. Better to accept that idea than to attempt to force change. Let LEDs be a part of lighting evolution without a revolution. The LED industry does not want to create a stigma about its technology through misuse and wait years for a recovery. Consider early impressions of fluorescent lights, for example.

INNOVATIONS EMBEDDED

ROHM
SEMICONDUCTOR



White LEDs

- Very high luminosity
- High heat dissipation
- Option of high CRI (Ra>90) for faithful color reproduction

World's brightest in the intermediate current range (50 to 150mA)

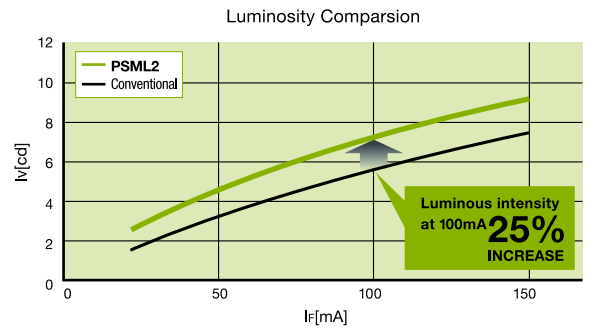

White LEDs in high heat dissipation PSML2 package

PSML2



4.0 x 2.0 (t=0.6mm)



Applications

These new LEDs are optimized for application of all types, including car navigation backlight, illumination, indicator displays, and gaming devices.

White LEDs in PLCC2 package

PLCC2



Part No.	Luminous Intensity (mcd)	Condition (mA)	Forward Voltage (V)	Chromaticity Coordinate (x,y)
SMLZ13WBDCW	1100	20	3.2	0.3, 0.28
SMLZ13WBDDW	1100	20	3.2	0.34, 0.34
SMLZ14WBDCW	2000	20	3.2	0.3, 0.28
SMLZ14WBDDW	2000	20	3.2	0.34, 0.34

Absolute Maximum Ratings (Ta=25°C)

- Power Dissipation-PD: 115mW
- Forward Current-IF: 30mA
- Operating Temperature-Topr: -40 ~ +100°C
- Storage Temperature-Tstg: -40 ~ +100°C



Cool Design

The purpose of thermal management is straightforward: to decrease the difference in temperature between the junctions of the LEDs and the ambient environment, ΔT_{JA} . Conventionally, reductions are achieved by increasing the net thermal transmission of all thermal paths from junction to ambient, in other words, increasing $W/m \cdot K$. However, that's half of the process – reducing the total thermal watts is equally effective at cutting down junction temperature. Aspects of optical, electrical, and mechanical design not normally associated with thermal management are explored here. In each case, approximate effects on ΔT_{JA} or ΔT_{CA} (case to ambient temperatures) are considered.

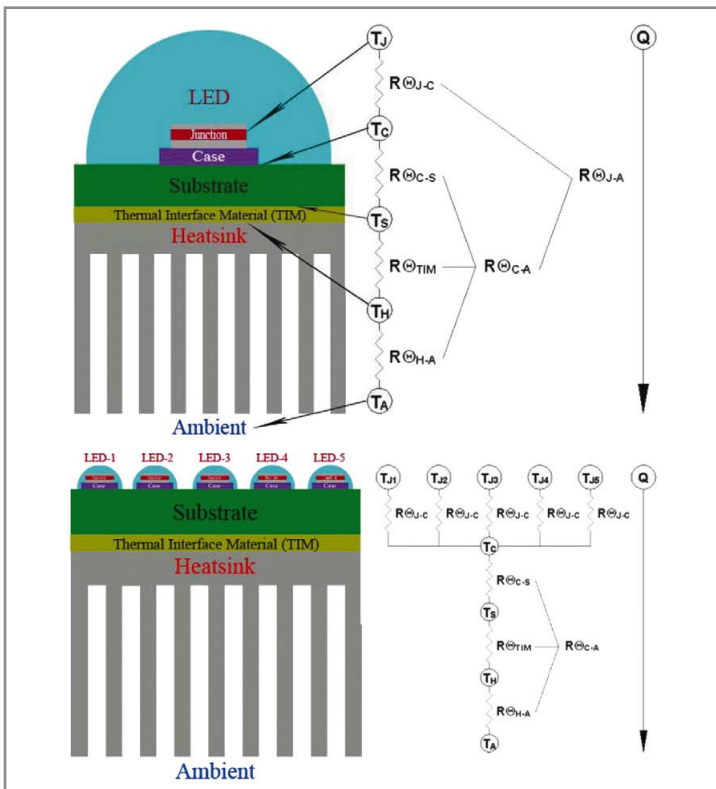

Figure 3: Simplified models of LEDs and their thermal management materials. Spreading the heat among more LEDs with lower ΔT_{JC} acts to reduce the total ΔT_{JA} . Heat produced at the junction must pass through all of the "resistors" along the path to the ambient environment. Removing resistors or creating parallel "circuits" can be equally or more effective than reducing the values of the resistors.

Higher efficacy components offer gains in performance that significantly reduce thermal strain. A premium paid here directly accomplishes the most obvious changes: to reduce the heat generated per watt and cut the number of watts applied. For example, 10% greater efficacy reduces ΔT_{JA} by 13%. It seems like a no-brainer to not pay a hypothetical 20% premium to increase efficacy by only 10%, but the net cost may actually be reduced in the long run by starting with higher efficacy components even when they seem cost-prohibitive. This premium exists at the time of design but will diminish relatively quickly within the product life cycle. Having higher efficacy components from the beginning allows for a more streamlined design, cutting some cost out of the mechanical and electrical aspects as well as reducing form and easing fit. In the long run, even more efficient components will become available, making thermal components less and less critical.

Adding LEDs can have the same impact as increased efficacy. Though it generally seems cost-prohibitive, adding components relieves the thermal load for each emitter and improves efficacy for the system overall. When 10% more components are used to produce the same number of lumens, ΔT_{JA} decreases by 5% because of the change in efficacy.

Rethinking the way light is currently delivered offers the opportunity to spread LEDs away from each other – here's the mistake made by cramming LEDs into bulbs or tubes. If the design is already limited by these old lighting conventions, thermal management will be challenging. Figuratively speaking, LEDs placed on thermal islands rather than one continent will have far less apparent thermal load. A nifty example would be streetlights. Shift the streetlight from a concentrated source in the cobra head to isolated sources along the arm and concerns about thermal management are eliminated. The streetlight no longer needs to support the large cobra head, so the form it takes is reduced and simplified. Depending on how far apart the LEDs can be, the differences in ΔT_{JA} vary greatly, but a nominal reduction would be 10% for designs that shift the light source from the form of a light bulb to the form of a reflector housing or fixture for that particular light bulb (i.e. spread the LEDs from a 2-3" diameter spheroid to a 5-6" diameter spheroid).

LEDs offer the unique ability to incorporate secondary optics and achieve high transmission efficiency within reasonable space. The easy potential choices too often selected are to not bother with optics at all or use commercially available, off-the-shelf lenses. Paying a premium for a custom lens seems prohibitive, but the marginal gains in optical efficiency can also provide a net reduction in manufacturing cost over a product's life cycle. A 10% gain in efficiency – and consequently 10% lower ΔT_{JA} – is generally possible by implementing custom secondary lenses and higher-transmitting diffusers compared to standard optics. In applications where light can be specifically targeted for tasks, custom optics may achieve 30% higher or better efficiency by flattening intensity over the target area and sharpening the edges. Excess brightness in the target area and stray light outside of it waste electricity and add to the thermal management demand.

Virtually all LED products must convert or regulate input voltage and current to deliver the proper current to the components. The regulation circuit is too often located on-board with the LEDs. In this case, any heat dissipated by the regulator is managed by the same thermal system. Moving the regulation circuits away from the LEDs or using a separate power supply with constant current directly input to the LED board reduces junction temperature depending on how much heat is dissipated by the regulators. For a 12V system, it is not uncommon for 15-20% of the power applied to the circuit to be consumed by the regulator and converted entirely to heat instead of light. If half of that heat is isolated from the LEDs, ΔT_{JA} is reduced by 10%.

The most common regulation circuits used are linear in design. They do not increase or decrease the input voltage used by the circuit to drive the LEDs. If 2.0V of voltage overhead need to be provided to the regulator and the input voltage is 12V, the efficiency of this regulation circuit is only 83%. Switching to a buck (output voltage less than input voltage) and/or boost (output voltage greater than input voltage) switching circuit may add 5% to the overall product cost but will achieve 93-95% efficiency. That difference accounts for a 10-15% reduction in ΔT_{JA} .

If switching circuits are cost-prohibitive or cannot be used for other reasons (such as magnetic interference), using higher input voltage with linear regulation achieves similar gains. A good example would be comparing LEDs run with 12V input and 36V input. In both cases, 2V are needed for the linear regulator. With 10V left, 12V allows a single circuit of three LEDs and 36V supports 10 LEDs per circuit. If all LEDs are driven with equal current, the 36V system uses 11% less power, which equates to almost 9% lower ΔT_{JA} . ΔT_{JC} (LED junction to LED case) is not affected by the regulation efficiency, only ΔT_{CA} . As a result, slightly less thermal improvement is observed compared to the electrical efficiency gain.

Redesigning lighting fixtures to better use LEDs opens the door to another improvement. The enclosure of the fixture itself will be the heatsink. This aspect may appear to be part of the thermal design, but it fits better into the category of mechanical elements that facilitate thermal design. Direct LED integration eliminates thermal interfaces and impediments. Since air is one of the better insulators, particularly when it is stagnant within an enclosed environment, removing spaces between the LEDs and the outside environment is a critical step. The impact on ΔT_{JA} cannot be specifically pinpointed, but it is larger than the effects of other design changes proposed above.

Various design changes incrementally improve thermal performance though they have nothing to do with selecting substrates, heatsinks, active cooling devices, or interface materials. Though each impact is small alone, as more of these changes are added the net improvement is profound and the benefit of more expensive or larger thermal materials is reduced. Here are those changes and their nominal impacts on ΔT_{JA} :

- 10% higher efficacy LEDs, 13%
- Adding 10% more emitters, 5%
- Spreading the emitters apart, 10%
- Custom, high-efficiency secondary optics, 10%
- Switching from 12V and linear regulation to 36V or switching regulation, 10%
- Direct integration of LEDs to the enclosure or chassis, 10%

None of the changes seem large, but multiply them all together and ΔT_{JA} sees a net reduction of more than 45% and a net efficacy improvement of nearly 50%. The changes add 30% to the production cost and additional design time and tooling cost up front. However, similar junction temperature results are not possible by adding that much cost in thermal materials alone, and the ancillary efficacy improvement is mostly related to improved LEDs and optics. It is nearly impossible to reduce ΔT_{JA} this much by altering the thermal materials and design alone. The premiums necessary to squeeze extra W/K out of substrates, interface materials, and passive or active cooling devices often exceed the costs of most of these changes. Smart, efficient functional design enables developers to avoid the pitfalls of overemphasizing thermal management.

Conclusion

Thermal management is a fundamental part of designing effective LED products, but premium thermal materials and components serve to band-aid the problem rather than address it as best as possible. If applications are well defined and products are developed with an open mind that ignores prevailing conventions, junction temperatures will not stand in the way of successful LED implementation. When heat is a problem, the options necessary to rectify the predicament are not limited to applying extra cost to more thermally conductive materials or designs. Added cost can be directed to additional, better LEDs with similar effect. Non-recurring investments in optical and enclosure design are effective without adding new production costs. Extra attention paid to electrical design options such as regulation circuits, driver placement, and input voltages pays dividends in reduced LED temperatures. Each of these improvements has ancillary benefits beyond thermal performance – increased electrical efficiency and optical performance most particularly – that cannot be similarly achieved through investment in increased W/K alone. If, despite all efforts to maximize the functional design, premium thermal materials are still necessary to meet an application's needs with LEDs, it's likely that the application is on the fringe of LED applicability and should wait for better LEDs tomorrow. ■



LED-heatsinks acc. to customer specified demands optimized cooling concepts, prototype construction, advice with application based "thermal management"



LED heatsinks LED-mounting surface with additional copper plating, powerful heat dissipation



Star shaped heatsinks and extruded profiles application for LED-light cases, for fixed and flexible LED-line modules, profiles sold by the meter

Advanced Thermal Management Materials for LED Packaging

> Carl Zweben, Ph. D., Advanced Thermal Materials Consultant

Light-emitting diode (LED) heat dissipation, which affects performance, conversion efficiency, lifetime, and cost, is a key packaging design problem [1-5]. Thermal stress arising from coefficient of thermal expansion (CTE) differences is another important issue. To solve these problems efficiently, cost-effective materials with high thermal conductivities and low CTEs are needed.

Copper and aluminum both have good thermal conductivities, but high CTEs (17 and 23 ppm/K, respectively). Further, materials with thermal conductivities higher than that of copper (400 W/m-K) are desirable. Most traditional low-CTE materials, which date from the mid 20th century, have thermal conductivities that are little or no better than that of aluminum (~200 W/m-K) [6,7]. Another design issue is that low-density materials are needed for applications that are weight-critical or subjected to shock loads. The need for improved thermal materials was a key conclusion of an OIDA LED workshop [8].

Heat dissipation, thermal stresses and weight are also critical issues in packaging of laser diodes and microelectronic semiconductors, such as microprocessors, power semiconductors and high-power RF devices. Intel's acknowledgement that it had hit a "thermal wall" highlights the severity of the problem [9]. Laptop heating has become so severe that, in one case, medical treatment was required [10]. In response to these problems suppliers are developing an increasing number of advanced thermal management materials that have high thermal conductivities, low coefficients of thermal expansion (CTEs) and low densities.

Thermal stresses arise primarily from CTE differences. Semiconductors and ceramics have CTEs in the range of 2 to 7 ppm/K. The CTEs of copper, aluminum and glass fiber-reinforced polymer printed circuit boards (PCBs) are much higher. Traditional, decades-old, low-CTE materials like copper/tungsten and copper/molybdenum, have high densities and thermal conductivities that are no better than that of aluminum. We call these first generation materials. Note that even when liquid cooling is used, thermal stresses caused by CTE mismatch are still important.

Weight is a key consideration in portable systems such as hand sets, notebook computers, hybrid automobile electronics, avionics, etc. Even if system weight is not itself an issue, low-density materials are needed for components like heat sinks to minimize shock load stresses during shipping.

Use of heat-spreader materials with high CTEs often requires significant design compromises that reduce cooling efficiency and can increase cost. For example, it is common to employ compliant polymeric thermal interface materials (TIMs) in electronic systems when aluminum and copper, are used. Polymeric TIMs increasingly account for most of the total system thermal resistance in microprocessor packaging [11].

This problem can be overcome by direct solder attach, but this raises important thermal stress issues. A similar situation occurs in attachment of high-power laser diode heat sinks. At present, the solution is to employ "soft" solders, typically Indium based, which have low yield stresses. However, these solders also have poor thermal fatigue and metallurgical characteristics. Use of materials with matching CTEs allows the design engineer to select from a wider range of solders.

Advanced Thermal Management Materials

In response to the well-documented needs just described, an increasing number of high-performance advanced materials have been, and are continuing to be developed for photonic and microelectronic applications. Advantages include: thermal conductivities up to more than four times that of copper; low, tailorable CTEs (from -2 to +60 ppm/K); electrical resistivities from very low to very high, extremely high strengths and stiffnesses; low densities; and low-cost, net-shape fabrication processes. Demonstrated payoffs include: improved and simplified thermal design; elimination of heat pipes, fans and pumped fluid loops; heat dissipation through PCBs; weight savings up to 90%; size reductions up to 65%; reduced power consumption, reduced thermal stresses and warpage; CTE match allows direct attach with hard solders; increased reliability; improved performance; increased PCB natural frequency; increased manufacturing yield; potential for reduction in the number of devices and for part and system cost reductions.

High-performance thermal management materials fall into two broad categories: monolithic carbonaceous materials and composites. A composite material can be defined as two or more materials bonded together [12]. This distinguishes composites from metallic alloys, which depend on solubility. There are five main classes of composites: metal matrix composites (MMCs), carbon matrix composites (CAMCs), ceramic matrix composites (CMCs), and polymer matrix composites (PMCs) [6,7,13,14]. Carbon/carbon composites (CCCs) are the most important type of CAMC at this time. The states of development of advanced thermal management materials range from R&D to full scale production.

Composites are nothing new in electronic packaging. For example, E-glass-fiber-reinforced polymer (E-glass/polymer) printed circuit boards (PCBs) are PMCs and copper/tungsten and copper/molybdenum are MMCs, rather than alloys. In addition, there are numerous ceramic particle- and metal particle-reinforced polymers used for TIMs, underfills, encapsulants and electrically conductive adhesives. All of these are PMCs.

The first second-generation thermal management material, silicon carbide particle-reinforced aluminum, commonly called Al/SiC in the packaging industry, is an MMC that was first used in microelectronic and optoelectronic packaging by the author and his colleagues at GE in the early 1980s [13]. As the technology matured and use increased, component cost dropped by several orders of magnitude. For example, microprocessor lids now sell for US\$2 to US\$5 in large volumes. Some types of Al/SiC reportedly are cheaper than copper, and several are less expensive than copper/tungsten and copper/molybdenum. Al/SiC has

been used for some time in many high-volume commercial and aerospace microelectronics and optoelectronic packaging applications, demonstrating the potential for advanced materials.

We are now in the early stages of the third generation of packaging materials. Several are being used in production applications, including servers, notebook computers, plasma displays, PCB cold plates and optoelectronic packages. Considering that they were only commercialized in the last few years, this is remarkable progress.

Material/Reinforcement	Matrix	Inplane Thermal Conductivity (W/m-K)	Vertical Thermal Conductivity (W/m-K)	Inplane CTE (ppm/K)	Specific Gravity
Aluminum	-	218	218	23	2.7
Copper	-	400	400	17	8.9
Alloy 42	-	10.5	10.5	5.3	8.1
Kovar	-	17	17	5.9	8.3
Titanium	-	7.2	7.2	9.5	4.4
Tungsten	Copper	157-190	157-190	5.7-8.3	15-17
Molybdenum	Copper	184-197	184-197	7.0-7.6	9.9-10
Copper/Invar/Copper	-	88-268	13-31	4.0-10.6	9.3-9.8
Copper/Moly/Copper	-	220-305	125-160	6.2-6.8	9.3-9.8
CVD Diamond	-	500-2200	500-2200	1-2	3.52
Solder - Sn63/Pb37	-	50	50	25	8.4
Epoxy	-	1.7	1.7	54	1.2
E-glass Fibers	Epoxy	0.16-0.26	-	12-24	1.6-1.9

Table 1: Properties of traditional packaging and thermal management materials.

Table 1 presents thermal conductivities, CTEs and densities of traditional packaging and thermal management materials [6, 7, 13, 14]. Note that the in-plane and vertical (through-thickness) thermal conductivities of copper/invar/copper and copper/molybdenum/copper, which are laminated metals, are significantly different. As discussed earlier, copper and aluminum have high CTEs, and low-CTE materials, like tungsten/copper and molybdenum/copper have thermal conductivities that are no better than that of aluminum. The wide range of CTEs for E-glass/polymer PCBs results from a survey of numerous articles and manufacturers' data.

Material/Reinforcement	Matrix	Inplane Thermal Conductivity (W/m-K)	Vertical Thermal Conductivity (W/m-K)	Inplane CTE (ppm/K)	Specific Gravity
HOPG	-	1300-1700	10-20	-1.0	2.3
Natural Graphite	-	140-1500	3-10	-0.4	1.1-1.9
Pyrolytic Graphite Sheet	-	600-1700	~15	0.9	0.9-2.5
Industrial Graphite	-	95	-	7.9	1.8
Graphite Foam	-	45-70	135-245	-1	0.6-0.9
SiC Particles	Aluminum	150-255	150-255	4.8-16.2	2.7-3.1
Discontinuous Carbon Fibers	Aluminum	190-230	120-150	3.0-9.5	2.4-2.5
Discontinuous Carbon Fibers	Copper	300	200	6.5-9.5	6.8
Beryllia Particles	Beryllium	210-230	210-230	6.1-8.7	2.1-2.5
Diamond Particles	Aluminum	410-530	410-530	7.0-10.0	2.9-3.1
Diamond Particles	Copper	465-600	465-600	4.0-7.7	5.0-5.5
Diamond Particles	Cobalt	>600	>600	3.0	4.12
Diamond Particles	SiC	600-680	600-680	1.8	3.3
Silicon	Aluminum	126-160	126-160	6.5-17	2.5-2.6
Beryllium	Aluminum	210	210	13.9	2.1
Continuous Carbon Fibers	Carbon	350-400	40	-1.0	1.9-2.0
Copper	Industrial Graphite	175	-	8.7	3.1
Discontinuous Carbon Fibers	Polymer	20-290	3-35	4-7	1.6-1.8
Continuous Carbon Fibers	Polymer	300	10	-1	1.8

Table 2: Properties of key advanced thermal management materials.

Table 2 presents properties of key advanced thermal management materials [6,7,13,14]. As discussed, ideal materials have high thermal conductivities and CTEs that match those of the semiconductors and ceramics to which they are attached. A big advantage of composites is that by combining matrices of metals, ceramics and carbon with thermally conductive reinforcements like some types of carbon fibers, SiC particles, and diamond particles, it is possible to create new materials with high thermal conductivities and low, tailorable CTEs.

Materials represented include several forms of carbonaceous materials, such as natural graphite and highly oriented pyrolytic graphite (HOPG), and a variety of composites. Since some advanced materials are anisotropic, inplane and through-thickness thermal conductivities are presented. Space limitations prevent a detailed discussion of the many materials. More detail can be found in references 6, 7, 12, 13, and 14.

We see that materials with thermal conductivities as high as 1700 W/m-K are available. Most have low densities and CTEs that are much smaller than those of aluminum and copper. Note that the CTEs of some carbonaceous materials are negative, but small. Silicon-aluminum and beryllium-aluminum can be considered to be metal matrix composites, because the constituents tend to come out of solution at room temperature, although some refer to them as alloys, which they are at higher temperatures.

Advanced Thermal Management Material Example

It is well known that the conversion efficiency of electrical power to light decreases with increasing temperature, making advanced thermal management materials attractive for LED packaging. This is well demonstrated in reference 15, in which LED arrays are attached to E-glass/epoxy PCBs, called printed wiring boards (PWBs) in that work.

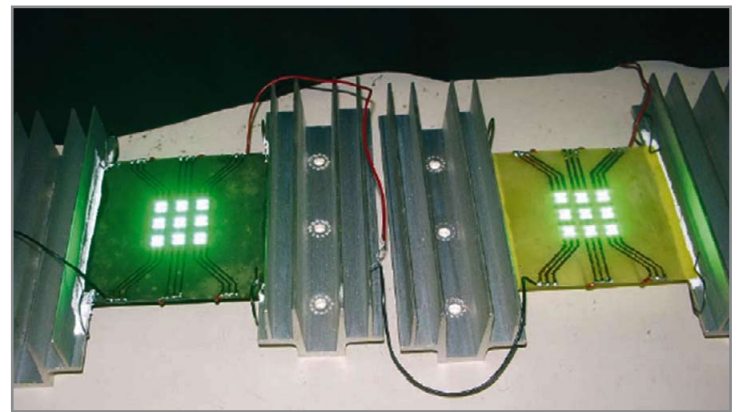

Figure 1: LED arrays attached to E-glass/epoxy printed circuit boards (printed wiring boards - PWBs) with (left) and without (right) a highly-oriented pyrolytic graphite (Advanced Pyrolytic Graphite - APG) heat spreader [15].

The board on the left of figure 1 is the high-conductivity PWB (HCPWB), in which the PWB is bonded to a copper-clad highly oriented pyrolytic graphite (the manufacturer calls this material Advanced Pyrolytic Graphite - APG) heat spreader. The HCPWB has an effective inplane thermal conductivity of 500 W/m-K, significantly higher than that of copper (400 W/m-K). The HOPG is located in the center of the HCPWB to prevent warping.

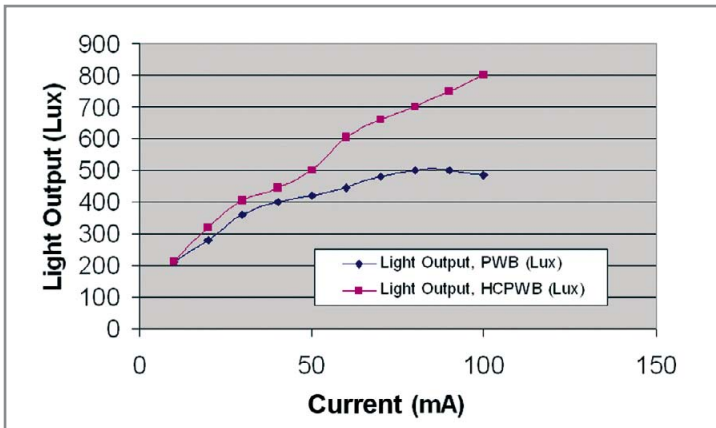

Figure 2: Light output as a function of power for LED arrays with and without a highly-oriented pyrolytic graphite (Advanced Pyrolytic Graphite – APG) heat spreader [15].

The light output varies with input power for the two boards (figure 2), clearly demonstrating the benefits of improved heat dissipation [15]. For example, at 100 mA, the HCPWB output is 60% greater. Note that the light output of the standard PWB array eventually decreases as power level increases, while that of the HCPWB continues to increase, because of the excellent heat dissipation provided by the HOPG.

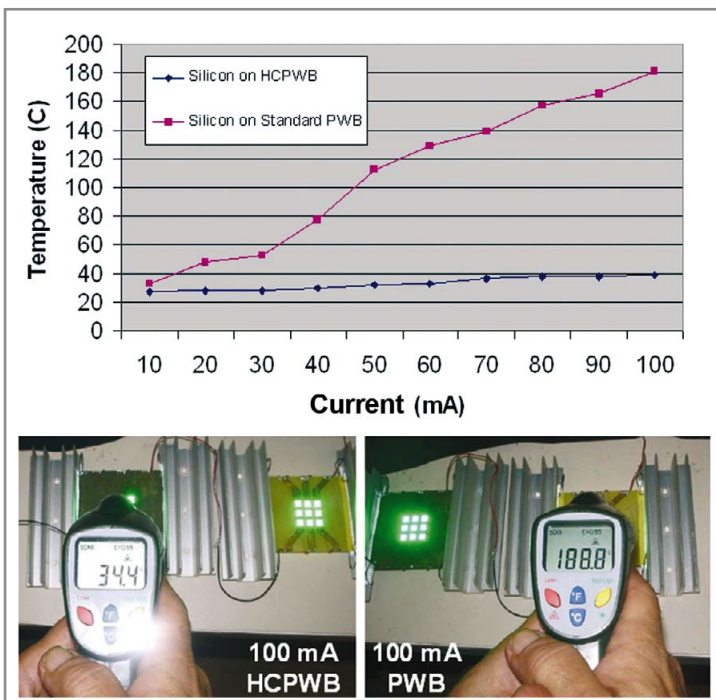

Figure 3: Temperatures of center LEDs, with and without a highly-oriented pyrolytic graphite (Advanced Pyrolytic Graphite – APG) heat spreader, as a function of power [15].

The temperature of the center LED of figure 3 explains the difference of PWBs with and without APG. The HCPWB LED temperature is 34.4°C, 154.4°C cooler than that of the conventional PWB (188.8°C).

Another potential benefit APG is that, because of its low, negative CTE, it may be possible to produce a PWB assembly with a much lower CTE.

Cost Issues

Cost is a complex issue involving many factors, such as part dimensions, complexity, flatness, roughness, quantity, etc. Space limitations preclude a thorough discussion. Most advanced thermal management materials are more expensive than aluminum. Some reportedly are cheaper than copper. However, component and system cost are both important. For example, lower operating temperatures increase output, which can reduce the number of LEDs required.

If we adopt the approach that the proof of the pudding is in the eating, we find that a number of advanced thermal management materials are being used in increasing numbers of commercial and aerospace applications, although, at this time, they are not well established in LED packaging.

Solving Manufacturing Problems with Composites

A key advantage of composite materials is that it is possible to tailor their CTEs. As discussed, CTE mismatch causes thermal stresses and warping that can result in failures during manufacturing, reducing yield. The author was called in to solve such a problem. In this case, a complex, expensive ceramic package, the yield was less than 5%. Modeling the many process steps using finite element analysis enabled us to define the required base plate CTE that would produce an acceptable level of warping. This increased yield to over 99%, saved the program over \$60 million, and prevented costly lawsuits.

Barriers to Use

There are a number of barriers to use of new materials. Cost is certainly high on the list. Another is the tendency to avoid risk, which is inherent with new technologies. A third barrier is the so-called "Valley of Death" between R&D and commercial production. This problem has been intensified by the current economic situation. Finally, there is a lack of awareness of the materials discussed in this article. This is being overcome, at least in part, by short courses run by major technical societies, such as IEEE, SPIE and IMAPS, some of which are presented in-house at commercial organizations.

The Future

We are in the early stages of a thermal management materials revolution. Al/SiC, the first second-generation thermal material, was only developed about two decades ago. In technology history, this is barely the blink of an eye. Most of the new, third-generation materials were only developed in the last few years. Based on this perspective, it seems reasonable to expect that in the future there will be significant developments in both materials and processes, leading to improved properties and reduced costs. Decreasing cost and increasing awareness will stimulate use in an increasing number of optoelectronic and microelectronic applications.

One intriguing area of interest is nanocomposites. Estimates of carbon nanotube thermal conductivity run as high as 6600 W/m·K. Values over 3000 W/m·K have been measured. Graphite nanoplatelets, which are much cheaper than nanotubes, are another candidate nanoscale reinforcement, as are nanoparticles of diamond and other thermally conductive materials. While the small size of nanoscale reinforcements results in a large number of interfaces that reduce effective thermal conductivity, the materials are certainly worth exploring. It may well be that these materials can be used with other reinforcements, such as thermally conductive carbon fibers, to produce hybrid composites with attractive properties. Another potential advantage of nanocomposites is reduced CTE.

Because of the unique ability of composites and other advanced materials to meet future packaging requirements, they can be expected to play an increasingly important role in the 21st century. ■

References:

1. S. Haque, et al., "Packaging Challenges of High-Power LEDs for Solid State Lighting", Proceedings of the 2003 International Symposium on Microelectronics (IMAPS 2003), Boston, MA, International Microelectronics and Packaging Society, pp. 881 – 886, 2003.
2. K. Lewotsky, "Lighting Rolls Forward", OE Magazine, pp. 12, October 2003.
3. S. Aanegola, J. Petroski, and E. Radkov, "Let There Be Light", OE Magazine, pp. 16-18, October 2003.
4. A. Bergh, et al., "The Promise and Challenge of Solid-State Lighting", Physics Today Online, December 2001.
5. A. Poppe and C. J.M. Lasance, "On the Standardization of Thermal Characterization of LEDs" On the Standardization of Thermal Characterization of LEDs, LED Professional Review, May/June 2009, pp.22-29.
6. C. Zweben, "Electronic Packaging: Heat Sink Materials", Encyclopedia of Materials: Science and Technology, K. H. J. Buschow, et al., Editors-in-Chief, Elsevier Science, Oxford, Volume 3, 2001, pp. 2676-83.
7. C. Zweben, "Advances in LED Packaging and Thermal Management Materials", Conference on Light-Emitting Diodes: Research, Manufacturing, and Applications XII (OE24), Paper Number 6910-45, Proceedings of the SPIE Symposium on Integrated Optoelectronic Devices 2008, 19-24 January 2008, San Jose, CA.
8. "Light-Emitting Diodes for General Illumination", Proceedings of the OIDA Workshop, Jeff Y. Tsao, Ed, November 2002.
9. J. Markoff, "Intel's Big Shift After Hitting Technical Wall", New York Times, May 17, 2004.
10. "Burned groin blamed on laptop", BBC News World Edition, November 22, 2002.
11. C. J. M. Lasance, "Problems with Thermal Interface Material Measurements: Suggestions for Improvement", Electronics Cooling, November 2003.
12. A. Kelly, Comprehensive Composite Materials, A. Kelly, and C. Zweben, Editors-in-Chief, Volume 1, Pergamon Press, Oxford, 2000.
13. C. Thaw, J. Zemany and C. Zweben, "Metal Matrix Composites for Microwave Packaging Components", Electronic Packaging and Production, pp. 27-29, August 1987.
14. C. Zweben, "Thermal Management and Electronic Packaging Applications", ASM Handbook, Volume 21, Composites, ASM International, Materials Park, Ohio, pp. 1078-1084, 2001.
15. M. Montesano, Thermacore, k Technology Division, private communication.



ArchiFlex™





BORN FOR WET LOCATION

ArchiFlex™ is a combination of SMD LEDs and extrusion technology. This IP68 rated flexible LED strip runs 30 meters a reel which can be powered merely by a transformer. The excellent performance with UV-resistance and V-1 fire rating guarantees outdoor applications.

info@signcomplex.com
www.signcomplex.com
Tell:+86-755-27608650
Fax:+86-755-27608651

Thermally Conductive Plastics: Balancing Material Properties with Application Needs

> Dr. Ir. R.H.C. Janssen, Dr. Ir. L. Douven, Dr. H. K. van Dijk, DSM Research

Having established that currently there is a ceiling conductivity of around 25 W/mK for TC-plastics, i.e., well below the 100 W/mK TC level of metals, subsequently a basic analysis is provided on the suitability of materials with such moderate TC-levels in metal replacement. For this purpose, the ideal case of a unidirectional (1D) heat flow is considered and a more complex case of a bidirectional heat flow is analyzed. Finally, the thermal performance of TC-plastics in a real 3D part is demonstrated, i.e., the heat sink housing of an LED lamp. More specifically, a comparison is made between the thermal performance of the housing molded in a heat conductive plastic and that of an all-aluminum housing. This comparison clearly demonstrates general validity and practical value of the conclusions drawn in the sections before and highlights the outstanding suitability of TC-plastics for heat sinks in lighting applications.

Properties of Thermally Conductive Plastics

Thermoplastics are thermal insulators with typical thermal conductivities of $\lambda = 0.25$ W/mK. This is in great contrast to metals and ceramics, which are thermal conductors with λ s up to 200 W/mK. Therefore, to create TC-plastics, a commonly used strategy is to add thermally conductive fillers to a thermoplastic matrix via compounding techniques.

In order to obtain a significantly enhanced thermal conductivity via the addition of TC-fillers, it is important that the filler particles are closely packed. In other words, one needs to fill the thermoplastic matrix to such an extent, that the random close packing threshold (RCPT) of the filler particles is approached (RCPT=maximum volume fraction of filler particles that can be packed into the matrix upon random insertion), as expressed accurately by the Halpin-Tsai equation [1] and its Lewis-Nielsen refinement [2] (figure 1).

Thus, the enhancement of the thermal conductivity of a compound relies on proximity to the RCPT, enabling thermal transport along multiple parallel particle-to-particle paths. This is in great contrast to the onset of electrical conductivity by adding fillers to an insulating thermoplastic matrix, which relies on surpassing the percolation threshold (PT). This PT threshold typically lies well below the RCPT, as the PT is governed by the first establishment of a single particle-to-particle path only [3]. Electrical conductivity rises sharply upon the onset of percolation, whereas thermal conductivity requires proximity to the random close pack threshold. The reason lies in the very large difference between the electrical conductivities of matrix and filler (typically 20 orders of magnitude) and the much smaller difference in their thermal conductivities (typically 3 orders of magnitude). Therefore, significant enhancement of thermal transport requires multiple particle-to-particle paths, as associated with the random close pack threshold,

whereas the onset of electrical conduction is already strongly increased after establishment of a single particle-to-particle path only, as occurs upon first passing the percolation threshold.

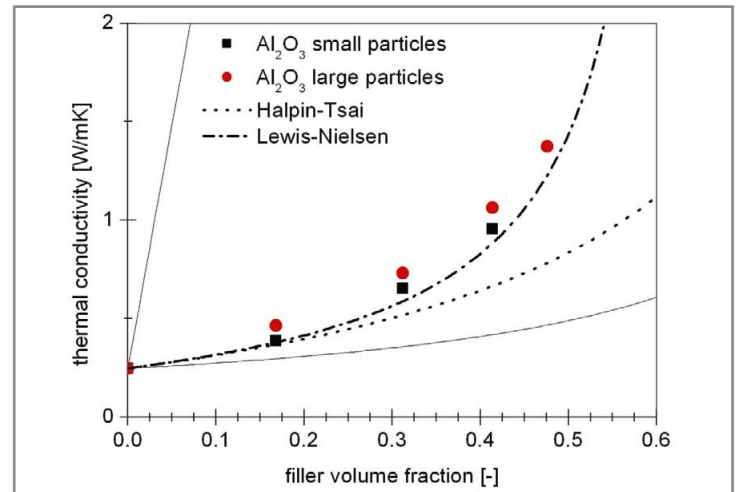

Figure 1: Experimentally obtained thermal conductivities of PA46 composites filled with close-to-spherical Al₂O₃ (Alumina) particles with sizes ≤ 10 μm (small particles, black squares) and > 100 μm (big particles, red circles). Thin full lines represent the well-known series (bottom) and parallel (top) boundary limits and dotted and dash-dot lines are the Halpin-Tsai and Lewis-Nielsen equation for spheres with $\lambda_p = 25$ W/mK in a matrix with $\lambda_m = 0.25$ W/mK. RCPT: $\phi_{2max} = 0.64$.

The necessity of close proximity to the random close pack threshold clearly leads to a trade-off between the thermal conductivity and toughness of a compound, as it is well known that an increase in rigid filler heightens its brittleness. This is illustrated in figure 2, showing the large deterioration in elongation at break of a thermoplastic with an increasing Al₂O₃ filler load.

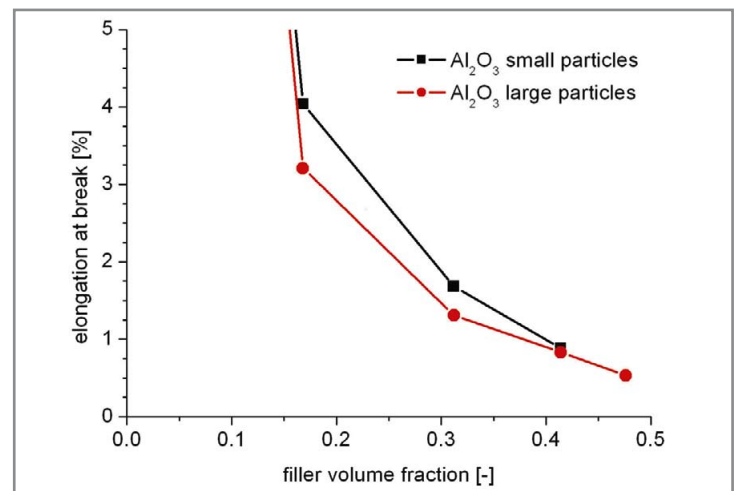

Figure 2: Elongation at break of compounds containing an increasing load of fine Al₂O₃ (black line) or coarse Al₂O₃ (red line) particles.

This trade-off can be avoided to a certain extent by going to filler particles with a higher aspect ratio. This helps to attain higher TC-values at lower filler fractions (figure 3: an estimation based on the Halpin-Tsai equation) leading to higher toughness at fixed TC-levels. Figure 4 shows an experimental demonstration of the large difference in TC between a compound filled with spherical Al₂O₃ particles (black line) and fibrous carbon particles (red line).

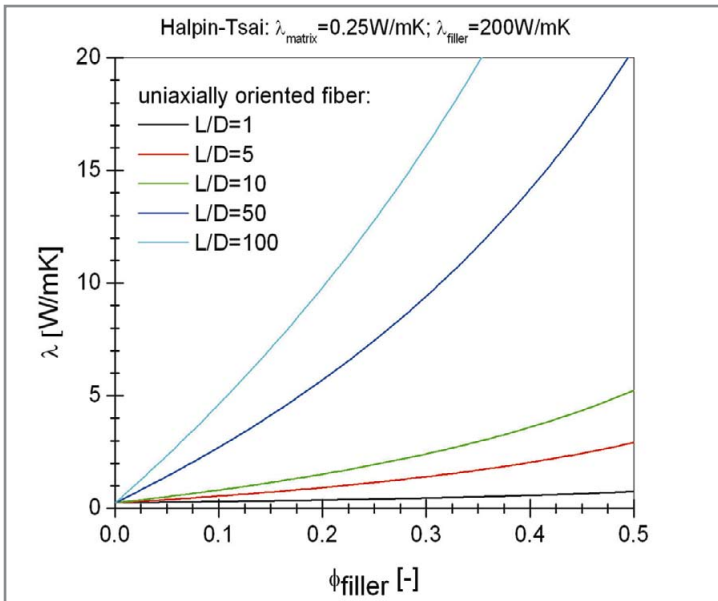

Figure 3: Halpin-Tsai calculation of compound conductivity versus filler load for uni-axially oriented fibers of $\lambda_{matrix}=0.25\text{ W/mK}$ and $\lambda_{filler}=200\text{ W/mK}$ and length-over-diameter L/D -ratios as indicated in the inset of the figure.

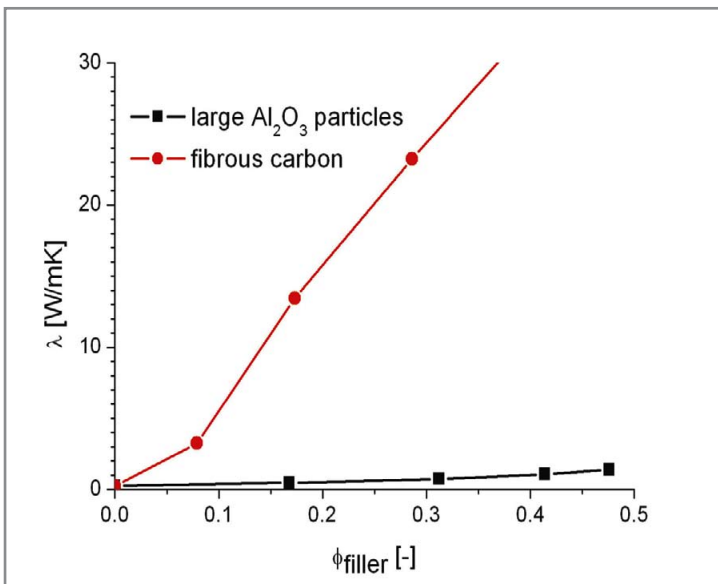

Figure 4: Thermal conductivity versus filler fraction for low aspect ratio particles (black line) and high aspect ratio particles (red line).

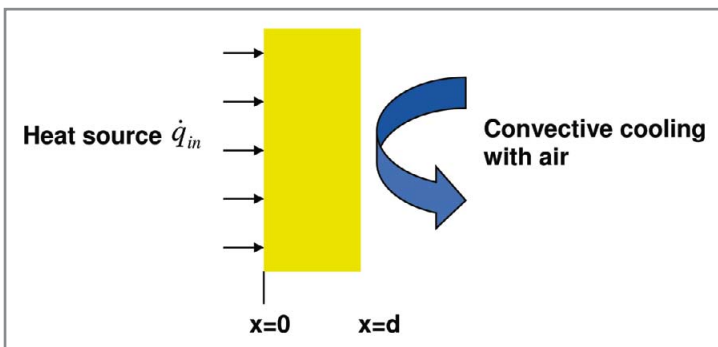

Figure 5: Schematic 1D heat flow through a polymer slab of thickness d and thermal conductivity λ .

From figures 3 and 4 it is clear that compounds with TC-values around 25W/mK are currently at the limits of our material design capabilities. This is largely governed by the lack of availability of TC-fillers with high aspect ratios $L/D > 100$. Since, $\lambda = 25\text{ W/mK}$ is well below $\lambda = 100\text{ W/mK}$ typical for metals, first the suitability of TC-plastics in metal replacement needs to be considered.

Uni-Directional (1D) Heat Flow: Conduction Versus Convection Limitation

In figure 5, a polymer slab is represented with thickness d and thermal conductivity λ that is exposed on one side to a heat flux per unit area $[\text{W/m}^2]$ and is convectively cooled from the other side with air of temperature T_{air} .

It is well known that the steady state temperature gradient ΔT across the polymer slab is given by

$$\Delta T = T_2 - T_1 = \frac{\dot{q}d}{\lambda} \quad [1]$$

with temperature T_1 on the cold side of the slab given by,

$$T_1 = T_{air} + \frac{\dot{q}}{h} \quad [2]$$

From equation 2 it follows that T_1 is governed by the convective cooling process only and is independent of the thermal conductivity of the slab. Equation 1 is displayed graphically in figure 6.

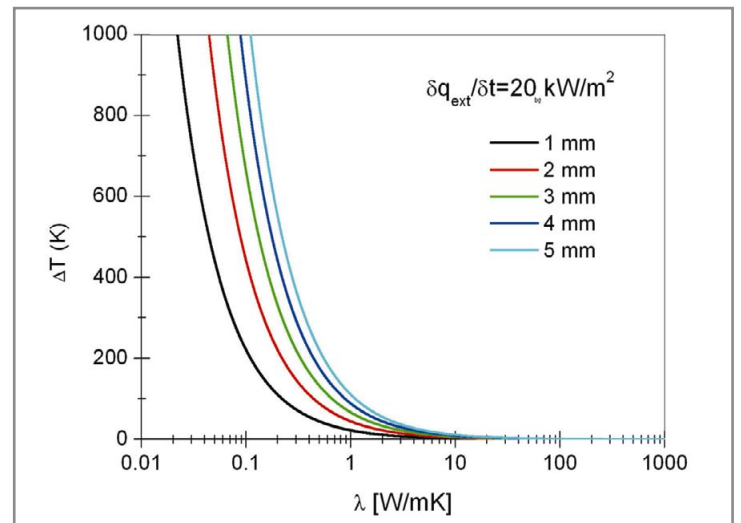

Figure 6: Temperature gradient versus thermal conductivity for 1D heat flow across a polymer slab. Slab thickness and heat in-flux are as indicated in the inset of the figure.

From this figure, essentially two regimes can be distinguished:

- A regime for $\lambda \geq 10\text{ W/mK}$ in which $\Delta T \rightarrow 0$. In this regime $T_2 \approx T_1$, i.e., the temperature across the slab is uniform and governed by convective processes only (see Eq. [2]). Therefore, this regime is called the convection-limited regime.
- A regime $\lambda < 10\text{ W/mK}$ in which $\Delta T \gg 0$. In this regime $T_2 \gg T_1$, i.e., there is a large temperature gradient across the part. This gradient is solely governed by the thermal conductivity λ of the slab (see Eq. [1]). Therefore, this regime is called the conduction limited regime.

Thus, from figure 6 it can be concluded that for the case of a 1D heat flow, one typically sits in the convection limited regime if $\lambda \geq 10 \text{ W/mK}$ (right hand side of figure 6). According to figure 6, in this regime there is no thermal penalty when replacing the material in the slab from one with a metal-like TC (100 W/mK) to one with a value $\lambda \approx 10 \text{ W/mK}$, which is typical for TC-plastics.

Conduction Limitations in Bidirectional (2D) Heat Flow & Design Rules

From the previous section it can be concluded that in unidirectional heat flow there is virtually no thermal penalty when metals with $\lambda \approx 100 \text{ W/mK}$ are replaced by TC-plastics with $\lambda \approx 5\text{-}25 \text{ W/mK}$. How valid is this statement for the case of a bidirectional heatflow? To answer this question, a finite element analysis (FEM) was performed on the model-geometry of figure 7, which consists of a cylinder shaped (polymer) housing that holds an aluminum disk.

A spatially homogenous heat influx of 7W or 10W is defined on the disk's top surface. This heat flows into the cylinder via a thermal contact between disk and cylinder that is assumed to be perfect. Heat is subsequently removed from the cylinder via convective air cooling on both the outside and inside of the cylinder.

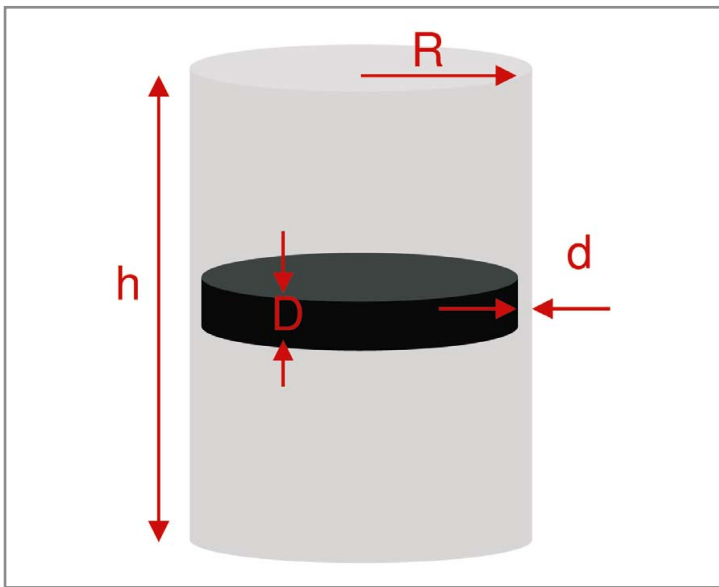

Figure 7: Polymeric cylinder of default thickness $d = 1 \text{ mm}$, height $h = 30 \text{ mm}$ and radius $R = 15 \text{ mm}$ containing an aluminum disk of default thickness $D = 2 \text{ mm}$ and radius $R = 15 \text{ mm}$. A spatially homogenous heat in-flux of 7 or 10 W is defined on the top surface of the aluminum disk. Convective cooling occurs on both outside and inside of the cylinder with heat transfer coefficient $h_{c,o} = 10 \text{ W/m}^2\text{K}$ and air temperature $T_{air,o} = 23^\circ\text{C}$ [outside cooling conditions] and $h_{c,i} = 3 \text{ W/m}^2\text{K}$ and $T_{air,i} = 50^\circ\text{C}$ [inside cooling conditions].

This cylinder and disk geometry was chosen, since it can be considered as an idealization of a LED lamp holder (see figure 10 for a FEM-graph) in which the heat flux has a 2D character only.

In figure 8, the maximum temperature difference ΔT between the hottest spot in a TC-plastic & aluminum disk configuration and an all aluminum configuration is plotted against the thermal conductivity of the cylinder material. Note from figure 8 that the characteristic shape of the curve is the same as in figure 6, reconfirming that the differences

in thermal performance between TC-plastic and aluminum largely vanish for $\lambda_{\text{cylinder}} > 10 \text{ W/mK}$ for which one enters the convection limited regime. Hence, it can be stated here that the conclusions with regard to metal replacement reached in the previous section for the case of a unidirectional heat flow, also hold for the current case of a 2D heat flow: for $\lambda_{\text{cylinder}} > 10 \text{ W/mK}$ one typically sits in the convection limited regime and there is only a minor thermal penalty when replacing highly conductive metals with λ around 100 W/mK by TC-plastics with moderate conductivities ($\lambda \approx 5\text{-}25 \text{ W/mK}$) only.

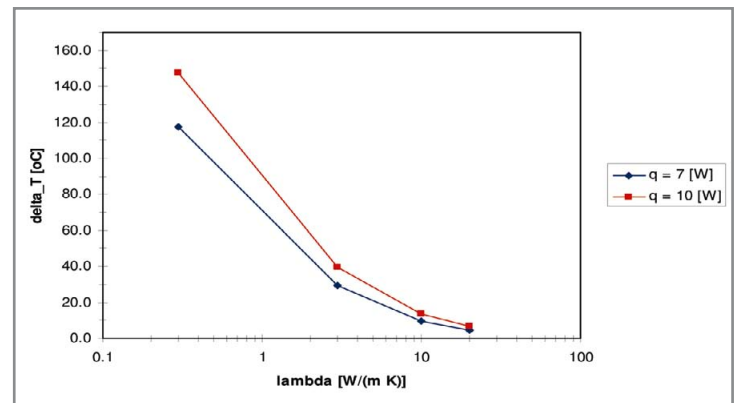

Figure 8: Calculated temperature difference between an all-aluminum and a TC-plastic cylinder & aluminum disk configuration (conditions are default as mentioned in the caption of figure 7)

In order to analyze how to further optimize the thermal performance of the 2D geometry under consideration, the influence of the main geometric parameters on the peak temperatures recorded was studied using FEM. The main findings of this study are shown in figure 9.

First of all, it was found that a very significant peak temperature reduction can be achieved by increasing the disk radius R. Essentially this lowers thermal load (in W/m^2) on the aluminum disk (compare the dark blue and pink curves in figure 9).

Secondly, it was established that it is beneficial to increase the thickness of the cylinder walls (dark blue and purple curves in figure 9). This leads to the creation of additional thermal pathway in the cylinder, very much comparable to the effects obtained by widening highways in order to resolve traffic jams.

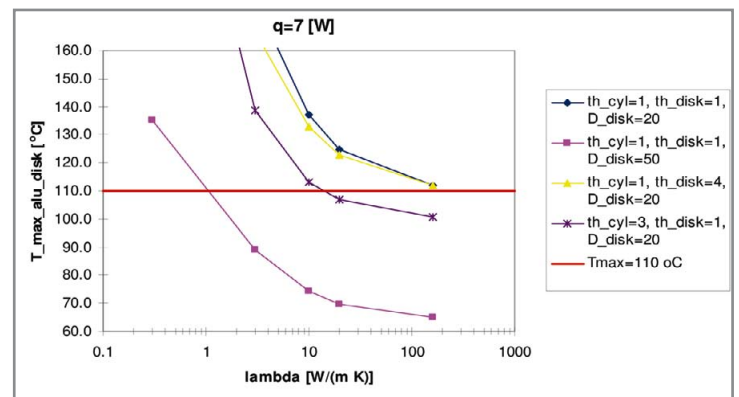

Figure 9: Maximum temperature of the aluminum disk versus thermal conductivity of the cylinder. Dark blue line: $d_{\text{cyl}} = 1 \text{ mm}$, $D_{\text{disk}} = 1 \text{ mm}$ and $R = 10 \text{ mm}$.

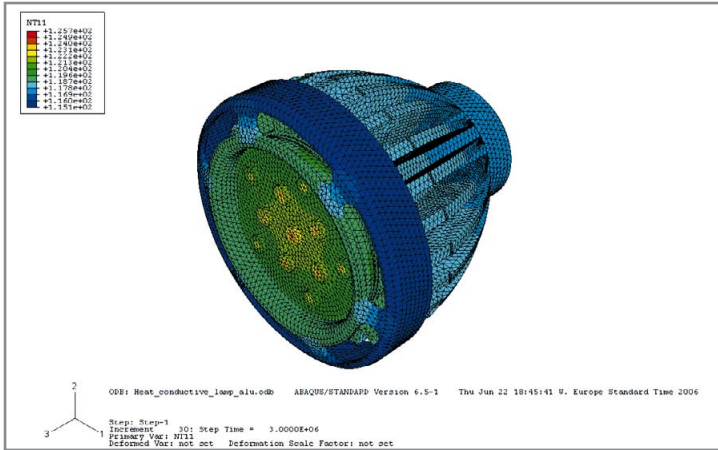

Figure 10.a: FEM calculation of local temperatures (in [°C], see inset) of an LED lamp housing in an all-aluminum design with $\lambda = 150$ W/mK and LEDs mounted on a Metal Core PCB. Note the very small difference $\Delta T = 10.6^\circ\text{C}$ between the maximum $T = 125.7^\circ\text{C}$ and minimum temperature $T = 115.1^\circ\text{C}$, recorded on the lamp.

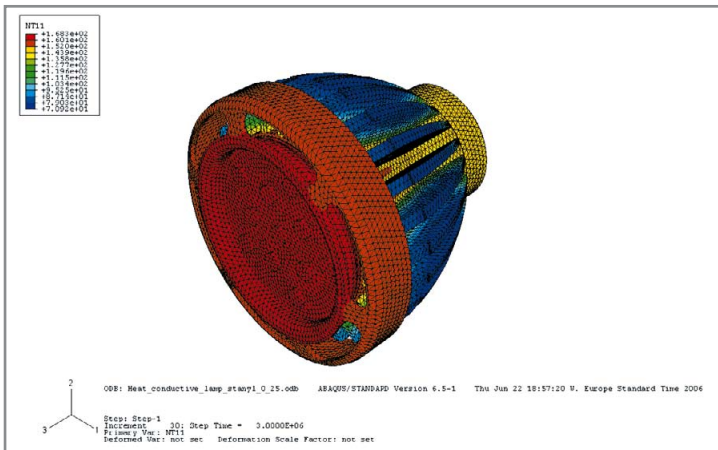

Figure 10.b: FEM calculation of an LED lamp holder with LEDs mounted on a Metal Core PCB enclosed in a low conductivity thermoplastic housing with $\lambda = 0.25$ W/mK. Note the very high difference $\Delta T = 97.4^\circ\text{C}$ between maximum temperature $T = 168.3^\circ\text{C}$ and minimum temperature $T = 70.9^\circ\text{C}$ recorded on the lamp (see inset for temperature read outs).

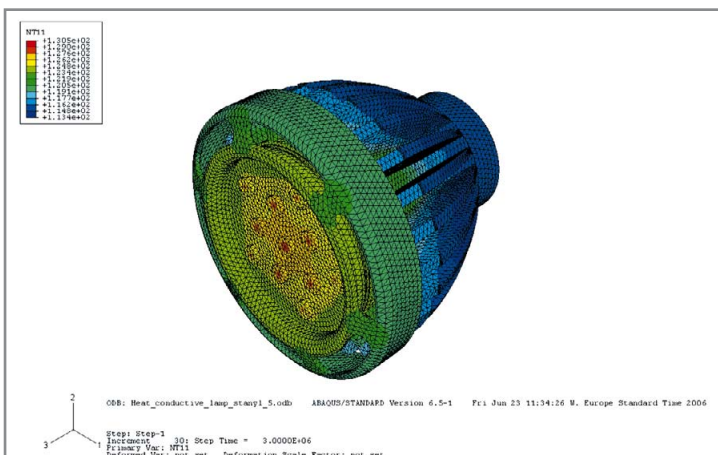

Figure 10.c: FEM calculation of an LED lamp holder with LEDs mounted on a Metal Core PCB enclosed in a TC-plastic housing with $\lambda = 5$ W/mK. Note that this fairly moderate λ of the thermoplastic housing is sufficient to minimize the thermal gradient across the lamp to $\Delta T = 17.1^\circ\text{C}$, a value far lower than in the regular plastic case of Figure 10.b and close to the all-aluminum case of Figure 10.a.

Finally, it was established that increasing the thickness of the aluminum disk is of minor relevance only (compare the dark blue and yellow curves in figure 9). This is a consequence of the fact that for the 2D geometry under consideration the bottleneck lies in the thermal transport along the walls of the cylinder and not in the transport within the disk.

Pink line: $d_{\text{cyl}} = 1\text{mm}$, $D_{\text{disk}} = 1\text{mm}$ and $R = 25$ mm.

Purple line: $d_{\text{cyl}} = 3\text{mm}$, $D_{\text{disk}} = 1\text{mm}$ and $R = 10$ mm.

Yellow line: $d_{\text{cyl}} = 1\text{mm}$, $D_{\text{disk}} = 4\text{mm}$ and $R = 10$ mm.

All other parameters as chosen as default as indicated in the caption of figure 7.

All in all, from the analysis presented in this section the following may be concluded:

For the 2D heat flow situation considered in figure 7, the convection limited regime is attained for $\lambda_{\text{cylinder}} > 10$ W/mK, allowing replacement of metals with $\lambda \approx 100$ W/mK by TC-plastics with $\lambda \approx 5$ -25 W/mK only.

Further design optimizations leading to a large reduction in peak part temperatures are certainly possible. This is true for both the all-aluminum configuration and the TC-plastic cylinder & aluminum disk configuration (see figure 9).

A Lamp Holder for an MR16 LED Lamp

Having established the feasibility of metal replacement from a conceptual point of view in previous sections, the analysis is now applied to the LED lamp holder of figures 10a-c. In this lamp, the LEDs generate a heat flux of 0.65W per LED. This thermal energy is subsequently transported via a Metal Core Printed Circuit Board (MCPCB) towards the lamp holder, where it is removed by convective air flow past a fin structure. Clearly, due to the presence of cooling fins, the heat flow in this lamp has a full 3D-character. Nevertheless, the results of our FEM calculations, displayed in figures 10a-c, show that the conclusions reached on the 1D and 2D cases are still valid here.

More particularly, a comparison of figure 10a and b shows that it is not possible to replace the aluminum LED housing by a conventional low-conductivity plastic. However, a comparison of figure 10a and c shows that a TC-plastic with $\lambda = 5$ W/mK is already sufficient to largely diminish the thermal gradients that develop when using insulating plastics, to values in relatively close proximity to the all-aluminum case.

Therefore, this calculation serves as a demonstration of the usefulness of TC-plastics in metal replacement for heat management purposes. This conclusion has also been validated experimentally. The LEDs in an all-aluminum version of the lamp displayed in figure 10 were only marginally colder $\sim 3^\circ\text{C}$ than in the plastic version of the same lamp, thus demonstrating the suitability of TC-plastics in LED lighting applications.

In conclusion, this statement is particularly true since TC-plastic parts are characterized by a large design freedom due to their ability to be injection molded, facilitating optimal use of the geometric design optimizations discussed in the previous section. ■

References:

- [1] J.C. Halpin, J.L. Kardos, "The Halpin-Tsai equations: A review", *Polym. Eng. Sci.* 16(5) (1976), 344-352.
- [2] L.E. Nielsen, "The thermal and electrical conductivity of two-phase systems", *Ind. Eng. Chem., Fundam.*, 13(1) (1974), 17-20.
- [3] R. Consiglio, D.R. Baker, G. Paul, H.E Stanley, "Continuum percolation threshold for mixtures of spheres of different sizes", *Physica A* 319 (2003), 49-55.

Drivers

Driver Design Based on System Blocks

> Jon D. Pearson, Cypress Semiconductor Corp.

If you keep up-to-date reading trade journals, newsletters, technical blogs, and visits with vendors, you will hear about a great many new developments: new devices, new hardware configurations, new tools. And each "source" will be trying to persuade you that their new thing is necessary to secure the success of your next design. But keep in mind, the success of a product comes from the design and not from what it is designed with. If the design is weak and subservient to the elements it consists of, success may rest on the whims of a vendor's delivery, a protocol, a component. But, if your design is strong, you can succeed even when a component fails (or fails to arrive) and needs to be replaced, and you can build a legacy of successes by leveraging this strong design.

What constitutes a strong design? It begins as a system, not a set of components, with clear goals and a defined structure. Most products begin this way, at least in part; you can see it in the initial "block diagram", where blocks are seldom labelled with a specific vendor's component. Key blocks appear distinct and separate. For instance, the inputs separate from the control, communications separate from the outputs. Each block a piece of the puzzle, yet from this view, the designers can remove and replace a block to take the design from one product to another. It looks easy at the block-diagram level, but with implementation, too, it can be relatively easy, when the implementation stays true to the system design.

Do not just Implement as Fast as Possible

Many projects staffed with a senior design team (or a respected veteran) are quick to move from the block-diagram to the implementation, disregarding the clear subdivisions of the blocks for "efficient" or "tight" program code. The years spent wrestling with a particular MCU and its peripheral peculiarities or a specific compiler or a certain CPU instruction set takes over and the system block diagram becomes a concept view, showing the spirit of the design.

However, if there is any chance that a team will change personnel, add or replace team members, strong design is the answer to keeping your project on track. A new team member can quickly understand a system block diagram and when the implementation follows suit, find his or her place in the system and find the language with which to discuss the project. Drop a new person into an implementation-led project and you need two things: extra time to come up-to-speed, and willingness to accept the mistakes of past (because change takes time). Drop that same person into a strong-design-based implementation, and he or she can be productive in the first days.

It All Starts with the Block Diagram at a High-Level

When you design a simple application it is natural to create system-level view that describes the application in an implementation-agnostic fashion. This view is useful as a communication tool to upper management or, for example, the automated-test designer. Problems begin when this is treated as a "view" rather than the design, and if implementation does not flow-down from the system design. Consider a lighting system as illustrated in figure 1.

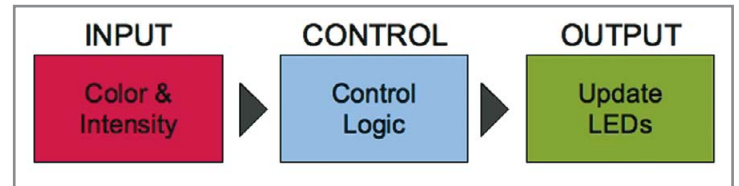

Figure 1: High-level system block diagram.

The system shown is relatively simple: Get inputs, Make control decisions, Update outputs. But this simple pattern reflects the design of many lighting products, and in general a wide range of embedded products. In this case we need inputs to select the LEDs color and Intensity, the system inputs block, the output of which feeds into the decision-making block. Based upon the inputs, the "Control Logic" block determines how to command each color, perhaps keeping the set of colors to a limited palette, or constraining how quickly a change takes effect, or translating a continuous range inputs into one of a set of discrete colors, and subsequently individual LED commands. The last block, the output block converts the LED commands into the control signals necessary to drive the LEDs.

As laid out, this is a straightforward and relatively simple application, so simple that rather than thinking about the system, one naturally jumps to implementation. And yet, this could be a home mood-lighting appliance (say a frosted glass column or coffee table base) or a professional stage light that will be installed along with multiple identical lights. The specific implementation for the home light would most certainly NOT suit the stage light without significant re-work. Which is the point, no matter how simple a design appears, there are good reasons to first design the system you want and then dream up how to implement it. And design it to fit as generic an application as possible, maintaining the commonality of the system.

A Strong Design Follows the System Block Diagram

To follow the path of a strong design, the system design needs to consider an ideal design, and then build layers and construct wrappers between the ideal system and real, sometimes messy, implementation. Start with the "Color & Intensity" block. Its reason for being is to get the current external command for the LEDs and provide it in a consistent format. Its services are "Get Color" and "Get Intensity". The hardware wrapper for the input block would cover anything necessary to

“translate” the raw user inputs to color and intensity in the expected format. This could mean considering the optimal timing of getting new readings. It could mean adding filtering algorithms if there is too much noise in the mechanical input devices. It could also mean applying some local decision logic, for instance if hardware appears to have failed. What comes out of the “Color & Intensity” block and is passed to the “Control Logic” is “ideal” colors and intensities, all messy, real-world details hidden behind easily replaced wrappers.

Getting Specific with a Small-Appliance Implementation

Let’s get specific to see how this works. Take the mood light home appliance, consisting of 4-color LEDs in a column of frosted glass with a small analog joystick controller that allows the user to set the color of the column based upon a color wheel; the joystick “moves” the current selection around a color wheel. We can update the original high-level system block diagram (from figure 1) to account for these new details, resulting in figure 2. The “input” block is expanded to show the joystick and analog-to-digital converter (ADC), which takes the user’s mechanical input and determines a position (X-Y). From the position information, this block decides the color and intensity, providing the services “Get Color” and “Get Intensity”, just like the original system design.

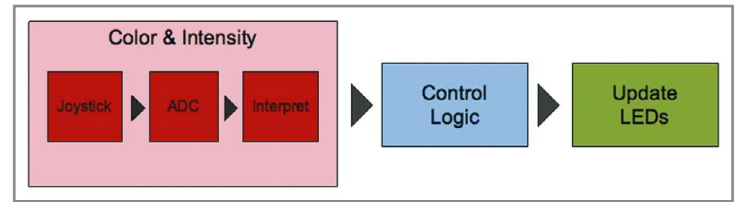

Figure 2: Joystick-controlled system block diagram.

While our implementation is visible in figure 2, in the expansion of the “Color & Intensity” block, the system design is preserved. Figure 3 further reveals the implementation details, one level lower, showing the design implemented with the Cypress PowerPSoC™ CY8CLEDO4D02, a programmable power device with configurable blocks including hysteretic PWM-controllers for precise high-brightness LED control. We use four channels of LED control (amber, blue, green and red) as well as the ADC to read the X and Y joystick inputs. This is the configurable block or System-on-Chip view of our implementation. The operation of the hardware blocks is tied together by the C-language program implementing the wrappers, with services (functions) like “byte GetColor(byte Which)” and “byte GetIntensity(byte Which)”. The specific program code is not shown here, but for more details of its implementation, you can refer to this application note: Using Four-Channel PowerPSoC in Small Form Factor Designs.

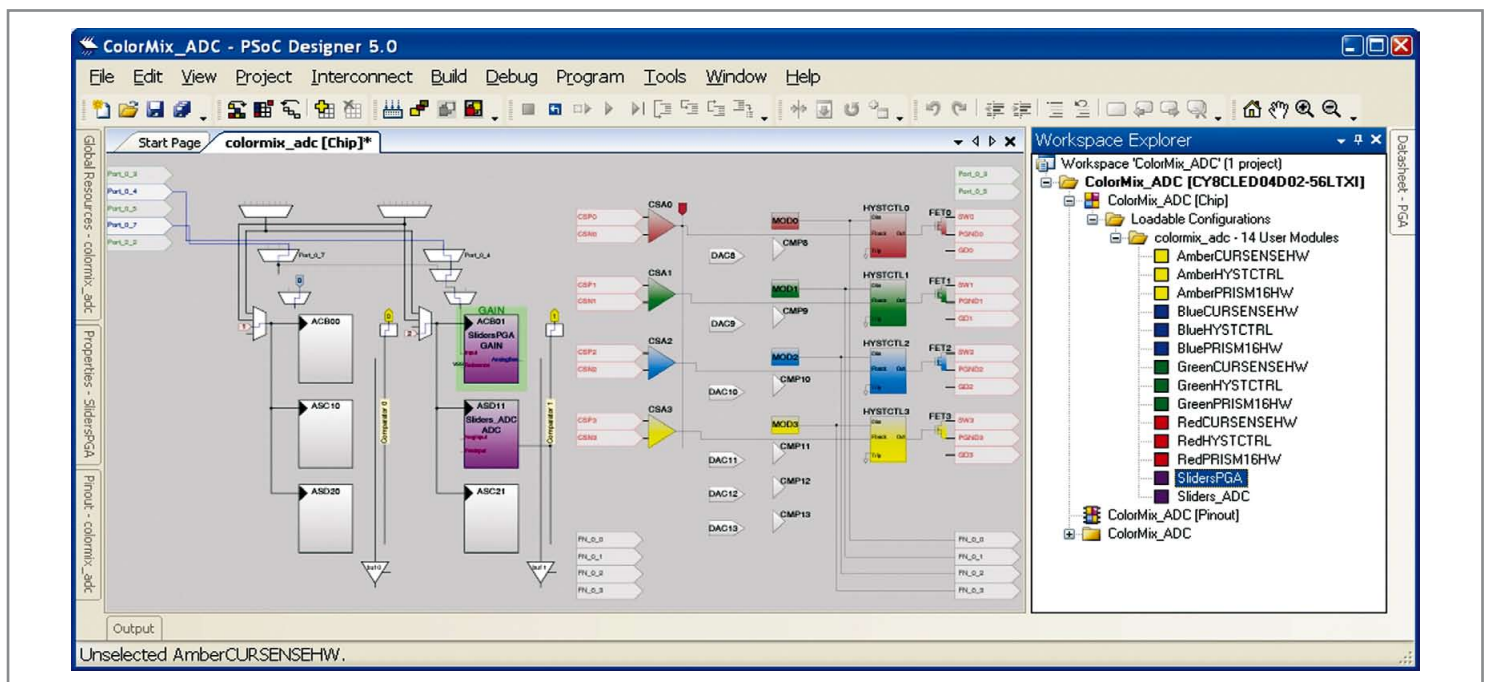

Figure 3: Joystick-controlled CY8CLEDO4D02 Implementation.

Figure 4 shows a chip-level block diagram for the CY8CLEDO4D02 PowerPSoC device along with a typical application circuit with four channels of LED control. In this device, much of the LED control and management is handled by the hysteretic PWM blocks with specialty hardware, but to the system design, those details would be “hidden” within the “Update LEDs” block, in its wrapper(s). The “Configurable

Analog” section is where the ADC for the joystick of the “Color & Intensity” block resides. Finally, the microcontroller “M8C Core” runs the program code implementing the control logic. All blocks of our design fit nicely in this one device, but by staying true to the system block divisions and allocations, this design could be adapted to a very different set of hardware, with only the wrappers requiring changes.

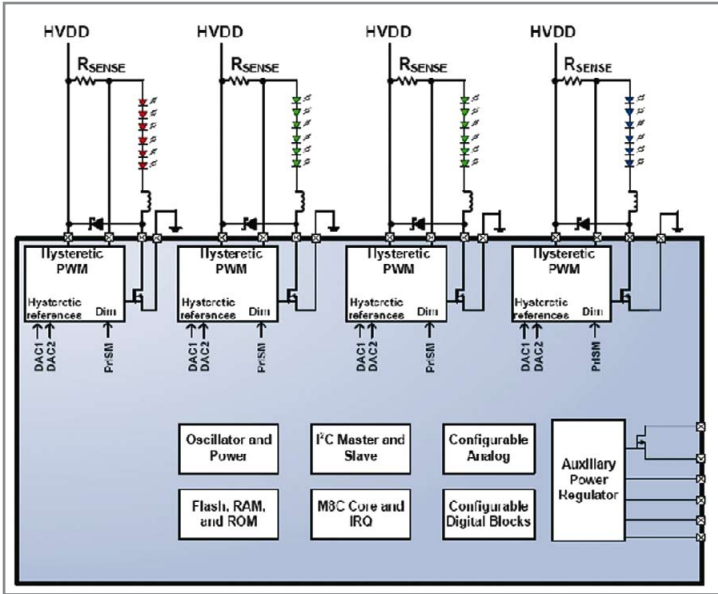

Figure 4: Joystick-controlled CY8CLED04D02 implementation.

Taking the Design to the Stage

The system design looks strong enough to sustain a change in hardware that is similar, such as migrating a design of multiple discrete devices and analog circuitry into an integrated device like PowerPSoC, but how do you take a standalone appliance design and adapt it to a stage lighting system? The stage light, a 4-color LED light will be only one of many identical lights controlled remotely with a DMX-512 controller. From the view of a single light, the new "detailed-system" diagram looks like figure 5. The expanded "input" block now replaces the joystick and analog-to-digital converter with a DMX512 receiver.

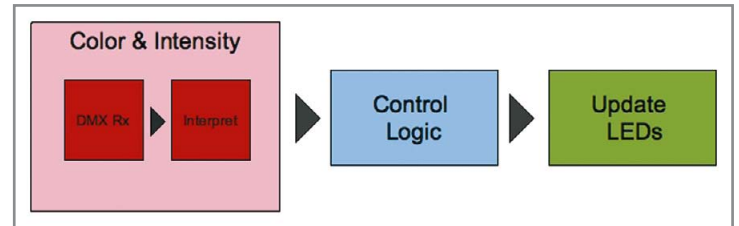

Figure 5: DMX-controlled system block diagram.

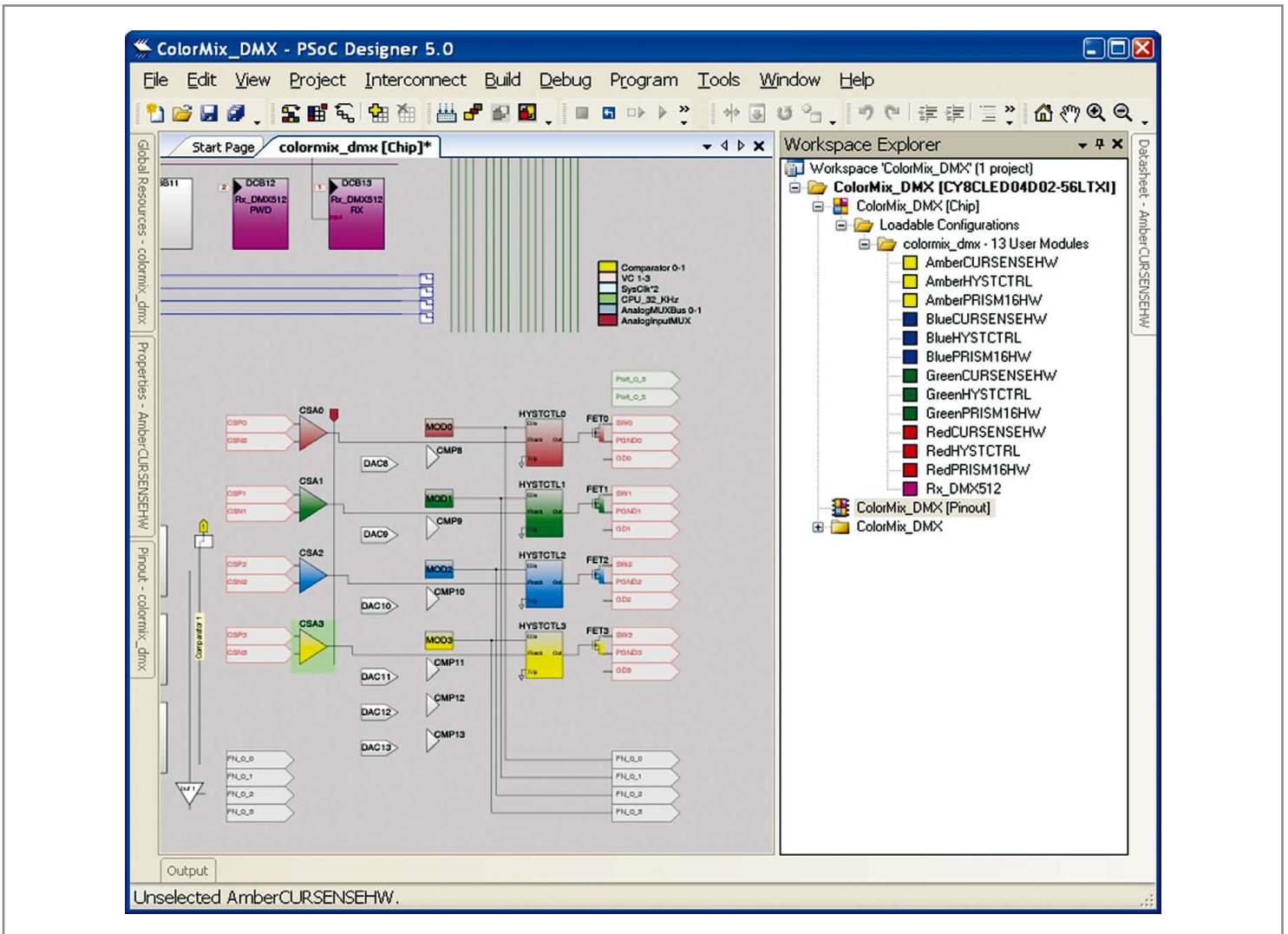

Figure 6: DMX512-controlled CY8CLED04D02 implementation.

If each of the sub-blocks within the original design also followed a strong block-based design, using wrappers and providing services, we can simply cut out the blocks we don't need and replace with the DMX512 wrappers and services. Since DMX512 protocol is simply a transport mechanism, the data may be encoded in any number of ways, with as many slots as required. Our 4-channel design would require at least 4 slots for a straightforward design with one slot for each of the colors. Even in a simple one-slot-per-color design, the data may need decoding or otherwise interpreting, so we might replace the "Joystick" and "ADC" blocks with a "DMX Rx" block and choose to convert the 8-bits of data to look just like the ADC's data did. Or we can revise the "Interpret" block to adapt to the new data format of "DMX Rx". The more wrappers around implementation details, the more flexibility we have to adapt to a new design. Figure 6 shows the stage-light design implemented in a PowerPSoC CY8CLED04D02.

One thing to notice in comparing figure 6 with figure 3, is that the difference is only one element. Replacing the ADCINC user module in the home appliance design with a DMX512 RX user module converts the design (the hardware at least) from home to stage. The development tool supporting PowerPSoC, PSoC Designer™, also follows a block-based methodology that supports our strong design, providing wrappers, called APIs (application programming interfaces), that wrap the details of the hardware implementation, the user modules, which makes adapting an implementation to a change, like replacing an analog input with a digital communications bus, much easier.

Bind It All Together with Strong Design

The tie that binds it all together: A system design hiding hardware details with hardware and implementation details wrapped up and hidden from the system. Driving these implementation details as far to the outer edges of the end-design, the code, protects the implementation from disruption, whether it is an unexpected component replacement or a planned upgrade. A strong design, one that stays true to the system design, allows each individual design to make the necessary implementation trade-offs for a successful project delivery and still provide re-use and support successful group design. Don't let the new shiny objects from the each visiting vendor take your eye off the ball – design the system first, aggressively protect this system design from the invading hoards of the implementation details. Then live well and prosper. ■



To Make the No. 1 Road Lamp & Patio Lamps Fair in China

The 3rd (Guangzhou) International Road Lamp, Patio Lamp & Outdoor Lighting Fair 2010

**Simultaneous Event:
LED City Landscape Lighting
& Road Illumination Forum**

March 26-28, 2010

Poly World Trade Center • Pazhou Complex

Organized by
Guangdong Enterprises for Foreign Economic Cooperation
Hongkong Grandeur International Group

Co-operated by
Guangzhou Grandeur Exhibition Service Co., Ltd

[Http://www.rlof.com](http://www.rlof.com) ☞

Organizing Committee Office Address:

Room 802B, No.38 JiaYue Building, Zhongshan Mid-avenue, Guangzhou Zip Code: 510660

Contact: Ms. Stella Nee

Tel: 86 20 6280 9756/62861787

Fax: 86 20 6286 1756

Mobile: 86 150 1332 1704



Annual *LED professional Review (LpR)* Article Index 2009

Event Reports

OLEDs 2009

by Alan R. Mills, LED professional LpR 16 – Nov/Dec 2009 p14

Project

LED Makeover, Yielding 90% Energy Saving

by Alexander Mueller, Future Lighting Solutions LpR 12 – Mar/Apr 2009 p16

Application

ALADIN – An Advanced Lighting System for Improved Health and Wellbeing

by Edith Maier, Walter Ritter, Univ. of Appl. Sciences Vorarlberg, and St. Gallen LpR 12 – Mar/Apr 2009 p20

A New White Light Solution Using an End-User Design Approach

by Gary Trott, Cree LED Lighting LpR 12 – Mar/Apr 2009 p28

Merging Technology and Biomorph Design

by Christie Liu, BComm Marketing & Lumolar LpR 12 – Mar/Apr 2009 p32

Light 2.0: LEDs Create an Entirely New Generation of Lamps

by Andreas Biß, Sharp Microelectronics Europe LpR 12 – Mar/Apr 2009 p34

The Future of LED Illuminators

by John Popovich, Column8 LpR 12 – Mar/Apr 2009 p38

Using RGB LEDs for Multi-Color Sign Applications

by Andreas Pohl, Avago Technologies LpR 14 – July/Aug 2009 p12

Effective Illumination for Internally-lit LED Signs

by M. Nisa Khan, Ph.D., LED Lighting Technologies LpR 14 – July/Aug 2009 p16

Interview with Navid Delassae – Citizen Electronics Germany

by Siegfried Luger, LED professional LpR 14 – July/Aug 2009 p20

Electrical Considerations of LED Bulbs

by Siegfried Luger, Arno Grabher-Meyer and Lukas Gorbach, LED professional LpR 15 – Sept/Oct 2009 p14

Optocouplers – A Critical Design Element in LED Bulbs

by Arno Grabher-Meyer, LED professional LpR 15 – Sept/Oct 2009 p17

Case Study – LED Solution Offers Advantages for Henkel Waste Water Plant

by Gordon Routledge, Dialight, Boris Viner, Consultant to Dialight LpR 15 – Sept/Oct 2009 p20

A Comparison of High Level European and U.S. Product Safety Requirements

by John Showell, Product Approvals Ltd. LpR 16 – Nov/Dec 2009 p16

Characterization

Defining Lighting Class LEDs

by Ralph Buehler, Cree Inc. LpR 11 – Jan/Feb 2009 p14

Methodology for Thermal and Electrical Characterization of Large Area OLEDs

by A. Poppe et al, Budapest Univ. of Tech., Mentor Graphics, Philips Research Lab. LpR 13 – May/June 2009 p15

On the Standardization of Thermal Characterization of LEDs

by A. Poppe et al, Budapest Univ. of Tech., Mentor Graphics, Philips Research Lab. LpR 13 – May/June 2009 p22

Effect of Thermal Environment on LED Light Emission and Lifetime

by Cathy Biber, Ph.D., Biber Thermal Design, Ltd LpR 13 – May/June 2009 p30

Technology

Jet Dispensing Technology for Capillary Underfiller

by Anton Knupfer, Essemtec AG LpR 11 – Jan/Feb 2009 p18

Quantum Dots in LED Lighting: Improving Color Quality Without Sacrificing Efficiency

by Dr. Sridhar Sadasivan, Dr. Seth Coe-Sullivan, QD Vision, Inc. LpR 14 – July/Aug 2009 p22

Chip-Array-on-Ceramic LED: A Versatile Solution to High Performance LED Luminaires

by Dr. Gang Wang, Dr. Ian Collier, Dr. Ilkan Cokgor, Harik Su and Dr. Yi-qun Li, Inteamtix Corp. LpR 14 – July/Aug 2009 p26

High Efficiency Reflective Mirror Type LED

by Shigeru Yamazaki, Alpha-One Electronics Ltd. LpR 15 – Sept/Oct 2009 p24

Low Cost of Ownership Lithography for High Brightness LED Manufacturing

by D. E. Anberg, Advanced Stepper Technology, A. M. Hawryluk, Ultratech Inc. LpR 16 – Nov/Dec 2009 p22

Optics

All Facts for Choosing LED Optics Correctly by Tomi Kuntze, LEDIL Oy	LpR 15 – Sept/Oct 2009	p28
Primary and Secondary Optic Materials – LED Luminaire Performance and Lifetime by Thomas Brukilacchio, Ph.D., Innovations in Optics Inc	LpR 15 – Sept/Oct 2009	p32
Shaping the Beam – the Role of Primary and Secondary Optics by Rudi Hechfellner, Philips Lumileds; Dave Cohen, Fraen Optical Manufacturing Group	LpR 15 – Sept/Oct 2009	p40
Save Space with Focus Tunable Lenses by Mark Blum, MSc EE , Manuel Aschwanden, PhD , David Niederer, MSc ME, Optotune	LpR 15 – Sept/Oct 2009	p43
Parameters to Consider for LED Optics Design by Guido Campadelli, Fraen Corporation	LpR 15 – Sept/Oct 2009	p46
Practical LED Light Measurement by Wolfgang Dähn, Bob Angelo, Gigahertz-Optik	LpR 16 – Nov/Dec 2009	p28
Photometric Measurements in Modern LED Based Optical and Illumination Systems by Juergen P. Weisshaar, Uta Vocke, opsira GmbH	LpR 16 – Nov/Dec 2009	p32
Imaging Colorimetry: LED Device, Luminaire and Display by Hubert Kostal, Radiant Imaging, Inc., Christina Boehme, SphereOptics GmbH	LpR 16 – Nov/Dec 2009	p36

Driver

Off-Line LED Control Circuit by Tom Ribarich, International Rectifier	LpR 11 – Jan/Feb 2009	p21
Current Uniformity for LED Display Drivers by Frank Shih, Macroblock	LpR 11 – Jan/Feb 2009	p25
Driving Compact Lamps Having High-Brightness LEDs by Rafael A. Pinto et al., Federal University of Santa Marial	LpR 11 – Jan/Feb 2009	p29
Basic Topologies for Driving LEDs by Steve Winder, Supertex Inc.	LpR 11 – Jan/Feb 2009	p33
Advantages of Integrating Power and Control for LED Lighting Applications by Gavin Hesse and Rakesh Reddy, Cypress Semiconductor .	LpR 13 – May/Jun 2009	p36
Constant Current Regulators Support LED Lighting Solutions by Tim Kaske, Paul Decloedt, ON Semiconductor .	LpR 13 – May/Jun 2009	p40
Primary Side Regulation: Low Cost and High Efficiency Offline LED Driver by Hangseok Choi, Fairchild Semiconductor	LpR 14 – July/Aug 2009	p30
Thermal Derating of LEDs by Steve Roberts, Recom	LpR 14 – July/Aug 2009	p32
Short Explanation of Critical Elements of a HB-LED Driver by Rakesh Reddy, Cypress Semiconductor Corp.	LpR 16 – Nov/Dec 2009	p50

Thermal Management

Ceramic Simplifies Heat Dissipation by Dr. Armin Veitl, Altair Engineering GmbH	LpR 12 – Mar/Apr 2009	p45
Comparison of Passive and Active Cooling Effectiveness by Che Cheung, Brandon Noska and Kim van der Heide, Nuventix .	LpR 13 – May/Jun 2009	p42
Thermal Management of High-Power LED Systems by Maurice J. Marongiu, PhD, MJM Engineering Co. .	LpR 13 – May/Jun 2009	p47
Selecting the Right Thermal Interface Material for LED Applications by Robert Kranz, Dr. Richard Hill, Laird Technologies, Inc .	LpR 13 – May/Jun 2009	p50
Thermal Management of Sophisticated LED Solutions by Dr. Michel Kazempoor, PerkinElmer .	LpR 13 – May/Jun 2009	p53
Design Process for a Customer-Specific Ceramic Heat Sink by Rüdiger Herrmann, CeramTec AG	LpR 13 – May/Jun 2009	p56
Thermal Management of High Power LEDs by Norbert P. Engelberts, Advanced Thermal Solutions	LpR 14 – July/Aug 2009	p36
When Designing with Power LEDs, Consider Their Real Thermal Resistance by Dr. András Poppe, MicReD Division, Mentor Graphics Corp.	LpR 16 – Nov/Dec 2009	p42
Silicones in LED's for Heat Dissipation and Improved Light Output by Chris Dawson, ACC Silicones	LpR 16 – Nov/Dec 2009	p46

LED professional – Patent Report

> Siegfried Luger and Arno Grabher-Meyer, Editors, LED professional

Intellectual properties play an important role in the still young and highly dynamic LED area. The number of patent applications and granted patents is continuously increasing and it's time-consuming to keep an overview. Therefore, LED professional publishes the bi-monthly "*LED professional - Patent Report*", which is released in conjunction with the *LED professional Reviews*. The report covers the US & EP granted patents in the field of LED lighting for the last two-month period. Every granted patent is highlighted with: a selected drawing (Derwent), the original patent title, a specifically re-written title (Derwent), the IPC class, the assignee/applicant, the publication number and date, and last but not least the original abstract.

With the "*LED professional - Patent Report*" it's easy to screen the IP-landscape, to check the "freedom-to-operate", to check if it is necessary to file an opposition, to monitor the competition or even to get inspired to make your own inventions.

LED professional – Patent Report (LpR 17)

Period: Nov 1, 2009 – Dec 31, 2009

Regions: US & EU

Application: General Lighting

Granted Patents: 175

Pages: 85

The LED professional – Patent Report is only available for LED professional Review (LpR) digital subscribers. If you have a valid subscription, please download the report by following this link: "[LED professional – Patent Report \(LpR 17\)](#)".

To order or renew your digital subscription: Please visit <http://www.led-professional.com/subscriptions>.

Country	Granted Patents
US	87
JP	22
TW	18
DE	16
KR	11
EP	10
CN	6
FI	2
AT	1
GB	1
RU	1

Table 1: Top priority countries

Assignee	Granted Patents
OSRAM	10
PHILIPS	10
CREE	8
AVAGO	7
FU ZHUN PREC INDUSTRY SHEN ZHE	7
SAMSUNG	6
IND TECH RES INST	4
LIGHTING SCIENCE GROUP CORP	4
PANASONIC CORP	4
EVERLIGHT ELECTRONICS CO LTD	3
GE	3
SEOUL SEMICONDUCTOR	3

Table2: Top assignees

IPC	Granted Patents	IPC Description
H01L	76	Semiconductor Devices
F21V	47	Functional Features or Details of Lighting Devices
H05B	11	Electric Lighting
F21S	7	Not-Portable Lighting Devices
H01J	6	Electrical Discharge Tubes
H01R	3	Electrically-Conductive Connections
F21K	2	Light Sources
G01J	2	Measurement of Mechanical Vibrations or Ultrasonic
G02B	2	Optical Elements, Systems, or Apparatus
G05F	2	Systems for Regulating Electric or Magnetic Variables

Table 3: Top technologies based on IPC-R(4 digits) codes

The gateway to success in Asian market

Most promising exhibition in the lighting industry.
500* exhibitors and 25,000* visitors gather.

(* expected)

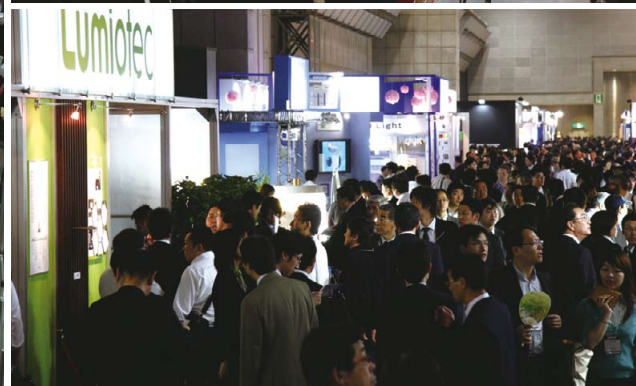
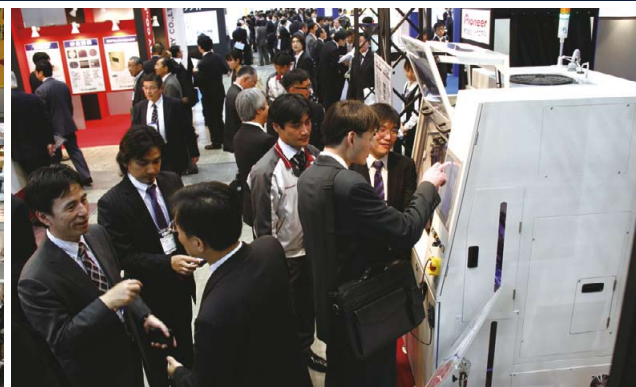

Lighting Devices

Equipment

Components

Materials

2nd **LED/OLED** Lighting Technology Expo

LIGHTING JAPAN

Dates : April 14 [Wed] - 16 [Fri], 2010

Venue : Tokyo Big Sight, Japan

Organised by : Reed Exhibitions Japan Ltd.

More Information >>> www.lightingjapan.jp/en/

Organised by
 Reed Exhibitions

LIGHTING JAPAN Show Management, Reed Exhibitions Japan Ltd.

18F Shinjuku-Nomura Bldg., 1-26-2 Nishishinjuku, Shinjuku-ku, Tokyo 163-0570, JAPAN
TEL: +81-3-3349-8568 FAX: +81-3-3349-0598 E-mail: light@reedexpo.co.jp

There is a new name for success with LED – TALEX.

www.tridonicatco.com



TALEXengine

With TALEXengine TridonicAtco sets another milestone in modern lighting technology – a complete system that builds the basis for a wide range of intelligent value-added lighting solutions. All the benefits of modern LED technology are built into this sophisticated but simple to use product: slim design, long life, true white light quality and not least the choice of application-specific colours. TALEXengine: More than just LED.

a world of bright ideas®

TRIDONIC.ATCO



TALEXengine – SLIM DESIGN AND FLEXIBLE LENGTHS FOR PRESENTING MERCHANDISE IN THE BEST LIGHT.

